

DETECTO®



APEX-RI Portable Scale with Remote Indicator Owner's Manual



INTRODUCTION

Thank you for purchasing our DETECTO APEX-RI Portable Scale with Remote Indicator. It has been manufactured with quality and reliability and has been tested before leaving our factory to ensure accuracy and dependability for years to come.

This manual is provided to guide you through the installation and operation of your scale. Please read it thoroughly before attempting to install or operate your scale and keep it available for future reference.

This manual is for use with the following APEX-RI Portable Scale with Remote Indicator models:

APEX-RI-AC	APEX-RI-ACMUK	APEX-RI-C-AC	APEX-RI-C-ACMUK
APEX-RI-ACEU	APEX-RI-ACUK	APEX-RI-C-ACEU	APEX-RI-C-ACUK

Copyright

All rights reserved. Reproduction or use, without express written permission, of editorial or pictorial content, in any manner, is prohibited. No patent liability is assumed with respect to the use of the information contained herein.

Disclaimer

While every precaution has been taken in the preparation of this manual, the Seller assumes no responsibility for errors or omissions. Neither is any liability assumed for damages resulting from the use of the information contained herein. All instructions and diagrams have been checked for accuracy and ease of application; however, success and safety in working with tools depend largely upon individual accuracy, skill, and caution. For this reason, the Seller is not able to guarantee the result of any procedure contained herein. Nor can they assume responsibility for any damage to property or injury to persons occasioned from the procedures. Persons engaging in the procedures do so entirely at their own risk.

FCC Compliance Statement

This equipment generates, uses, and can radiate radio frequency, and if not installed and used in accordance with the instruction manual, may cause interference to radio communications. It has been designed within the limits for a Class A computing device pursuant to Subpart J of Part 15 of FCC rules to provide reasonable protection against such interference when operated in a commercial environment. Operation of this equipment in a residential area may cause interference in which case the user will be responsible for taking whatever measures necessary to correct the interference.

You may find the booklet "How to Identify and Resolve Radio-TV Interference Problems" prepared by the Federal Communications Commission helpful. It is available from the U.S. Government Printing Office, Washington, D.C. 20402. Request stock No. 001-000-00315-4.

Contains FCC ID: 2ADHKWINC3400

1. This device complies with Part 15 of the FCC rules. Operation is subject to the following two conditions:
 - (1) This device may not cause harmful interference.
 - (2) This device must accept any interference received, including interference that may cause undesired operation.
2. Changes or modifications not expressly approved by the party responsible for compliance could void the user's authority to operate the equipment.

FCC Radiation Exposure Statement

This equipment complies with FCC RF radiation exposure limits set forth for an uncontrolled environment. This transmitter must not be co-located or operated in conjunction with any other antenna or transmitter. This equipment must be installed and operated with a minimum distance of 20 cm between the radiator and the user body.

PROPER DISPOSAL

When this device reaches the end of its useful life, it must be properly disposed of. It must not be disposed of as unsorted municipal waste. Within the European Union, this device should be returned to the distributor from where it was purchased for proper disposal. This is in accordance with EU Directive 2002/96/EC. Within North America, the device should be disposed of in accordance with the local laws regarding the disposal of waste electrical and electronic equipment.

It is everyone's responsibility to help maintain the environment and to reduce the effects of hazardous substances contained in electrical and electronic equipment on human health. Please do your part by making certain that this device is properly disposed of. The symbol shown to the right indicates that this device must not be disposed of in unsorted municipal waste programs.



CAUTION



CAUTION: RISK OF EXPLOSION IF BATTERY IS REPLACED BY AN INCORRECT TYPE. DISPOSE OF USED BATTERIES ACCORDING TO THE INSTRUCTIONS.

ATTENTION: RISQUE D'EXPLOSION SI LA BATTERIES EST REMPLAC'E PAR UN TYPE INCORRECT. REJETEZ LES BATTERIES UTILISE'ES SELON LES INSTRUCTIONS.

TRANSPORTATION AND STORAGE



Do Not Drop

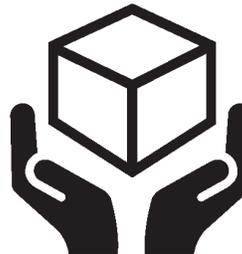

Handle with Care



Keep Dry

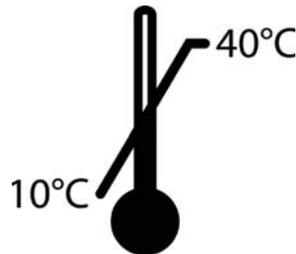

Temperature Range

Serial Number _____
Date of Purchase _____
Purchased From _____

RETAIN THIS INFORMATION FOR FUTURE USE

PRECAUTIONS	
Before using this scale, read this manual and pay special attention to all "NOTIFICATION" symbols:	
	
IMPORTANT	ELECTRICAL WARNING

TABLE OF CONTENTS

SPECIFICATIONS	Page 1
Standard Features	Page 1
Optional Features	Page 1
SITE PREPARATION REQUIREMENTS	Page 2
Environmental	Page 2
Electrical Power	Page 2
Electrical Noise Interference	Page 2
UNPACKING	Page 3
ASSEMBLY	Page 3
MOUNTING THE DISPLAY	Page 4
WEIGHING UNITS SELECTION	Page 5
INTERCONNECTIONS	Page 6
AC Power Adapter	Page 6
USB	Page 6
RS232 COM Port	Page 6
BATTERIES	Page 7
Battery Status	Page 7
Battery Installation/Replacement	Page 8
BATTERY SAVER FEATURE	Page 8
KEYPAD FUNCTIONS	Page 9
ANNUNCIATORS	Page 11
OPERATION	Page 12
Zero Weight Display	Page 12
Basic Weighing Operation	Page 12
Body Mass Index (BMI) Operation, Using Previously Measured Height	Page 12
MOTHER/BABY WEIGHING	Page 13
SCALE SETUP	Page 14
To Enter Setup	Page 14
Setup Navigation Keys	Page 14
DATA FORMAT	Page 21
WI-FI AND BLUETOOTH LOW ENERGY (BLE)	Page 22
Wi-Fi Features	Page 22
WI-FI SETUP	Page 22
Enable and Configure Wi-Fi Network Settings	Page 22
Configure Wi-Fi Network Module	Page 23
Changing the Network Credentials	Page 24
WI-FI OPERATION	Page 25
Web Server	Page 25
TCP/IP Connection	Page 26
SMA Commands	Page 26

TABLE OF CONTENTS, CONT.

BLUETOOTH LOW ENERGY (BLE)	Page 27
Features Available via BLE	Page 27
Enable and Configure Bluetooth (BLE) Network Settings	Page 27
Bluetooth Pairing	Page 27
INTERFACING TO BLE	Page 28
Standard Services per Bluetooth SIG	Page 28
Device Information Service (0x180A)	Page 28
Battery Service (0x180F)	Page 28
Weight Scale Service (0x181D)	Page 28
BLUETOOTH INTERFACE STANDARD PROTOCOLS	Page 29
Bluetooth Characteristic – Weight_Measurement: 0x2A9D	Page 29
Weight_Measurement: 0x2A9D	Page 29
Custom Services	Page 30
DETECTO SMA Service (0x907a0000-8699-47dd-ab30-d7aad5f83e54)	Page 30
SMA Commands	Page 30
WI-FI AND BLUETOOTH SMA COMMANDS	Page 31
PRINTING ON STABLE WEIGHT	Page 33
EVENT COUNTER	Page 34
Calibration Counter	Page 34
Configuration Counter	Page 34
To Review the Event Counter	Page 34
DISPLAY SCALE WI-FI AND BLUETOOTH SETTINGS (<i>Model apex-RI-C</i>)	Page 35
ERROR AND OPERATION MESSAGES	Page 36
BEFORE YOU CALL SERVICE	Page 36
CARE AND CLEANING	Page 37
PARTS IDENTIFICATION	Page 38
ACCESSORIES	Page 39
STATEMENT OF LIMITED WARRANTY	Page 40

SPECIFICATIONS

Models:	APEX-RI-AC (AC Adapter Power)	APEX-RI-C-AC (AC Adapter Power with Wi-Fi and Bluetooth BLE)
Capacity:	600 lb x 0.1 lb (270 kg x 0.05 kg)	
Weighing/Height Units:	Pounds/Inch (lb, in) or Kilograms/Centimeters (kg, cm)	
Platform Size:	17 in W x 17 in D x 2.75 in H (43 cm W x 43 cm D x 7 cm H)	
apex® Display Dimensions:	6.25 in W x 1.75 in D x 4 in H (16 cm W x 4.5 cm D x 10.3 cm H)	
Display Type:	Dual Row Seven Segment LCD	
Number of Characters:	Weight: 5 digits, 0.75 in (19 mm) high Height/BMI: 4 digits, 0.4 in (10 mm) high	
Keys:	Mechanical switch type, Power, Lock/Release, Zero, Up Arrow, BMI/Enter, Down Arrow/Print	
Power Requirements:	Domestic: Included 100 to 240 VAC 12 VDC 1A Wall Mount UL/CE Approved adapter with US (Type B) input plug (Cardinal part number 6800-1045) International: Included 100 to 240 VAC 12 VDC 1A Wall Mount Multi-Blade UL/CE Approved adapter with EU (Type C) and UK (Type G) input plugs (Cardinal part number 6800-1047) Batteries (<i>not included</i>) 12 AA cell Alkaline, Ni-Cad, or NiMH	
Operating Environment:	Operated Temperature Range: 14 to 104 °F (-10 to +40 °C) Humidity: 0 to 90% non-condensing	
Communication Interfaces:	RS232, USB, Wi-Fi, Bluetooth	
Certifications:	NTEP – Certificate of Conformance No. 21-079 OIML R-76 – EU Type Approval Certificate No. DK0199.558	
OIML Class III Compliant:	These models are also available as OIML Class III compliant by adding a -KGEU suffix to the model number when ordering. Capacity: 290 kg x 0.1 kg.	

Standard Features:

- Power-Up Zero
- Auto Weight Lock Feature
- StableSENSE®¹ Adjustable Filtering
- 1 RS232 Serial Port
- 1 Micro-B USB Port
- Bluetooth (BLE) / Wi-Fi on (-C) models

Optional Features:

- Battery Operation (*Batteries not included*)

¹ StableSENSE® is a digital filter utilizing a proprietary software algorithm that removes or greatly reduces changes in the weight display resulting from movement on the scale platform. When used with clinical scales, it will lessen the effects of the patient's movement or vibration on the scale.

SITE PREPARATION REQUIREMENTS

The DETECTO APEX-RI Portable Scale with Remote Indicator is a precision weight indicating instrument. As with any precision instrument, it requires an acceptable environment to operate at peak performance and reliability. This section is provided to assist you in obtaining such an environment.

Environmental

- For indoor use only.
- Suitable for dry environments only RH < 90% and non-condensing environments.
- NEVER allow the scale to get wet.
- The scale meets or exceeds all certification requirements within a temperature range of 14 to 104 °F (-10 to +40 °C).

The scale should be placed out of direct sunlight and to provide adequate air circulation, keep the area around the scale clear.

Do not place the scale directly in front of a heating or cooling vent. Such a location will subject it to sudden temperature changes, which may result in unstable weight readings.

Ensure that the scale has good, clean AC power, and is properly grounded. In areas subject to lightning strikes, additional protection to minimize lightning damage, such as surge suppressors, should be installed.

Electrical Power

The DETECTO APEX-RI Portable Scale with Remote Indicator has been designed to operate from a 100 to 240 VAC 50/60Hz 12 VDC 1 A Wall Mount AC Power Adapter.

- The socket outlet supplying power to the scale should be near the scale and be easily accessible.
- On installations requiring 230 VAC power, **it is the responsibility of the customer** to have a qualified electrician install the proper power adapter plug that conforms to national electrical codes and local codes and ordinances.

Electrical Noise Interference

To prevent electrical noise interference, make certain all air conditioning and heating equipment, lighting, or other equipment with heavily inductive loads, such as welders, motors, and solenoids are on circuits separate from the system. Many of these disturbances can seriously affect the operation of the system. These sources of disturbances must be identified and steps must be taken to prevent possible adverse effects on the system. Examples of available alternatives include isolation transformers, power regulators, uninterruptible power supplies, or simple line filters.

UNPACKING

Carefully remove the scale from the shipping carton and inspect it for any damage that may have taken place during shipment. *Keep and use the original carton and packing material for return shipment if it should become necessary.* The purchaser is responsible for filing all claims for any damages or loss incurred during transit. Remove all plastic wrapping, foam fillers, and cardboard material from the scale platform, display, and other components. You should have the following components:

- Scale Base with attached Display
- Scale Base Cover
- apex® Wall Mount Kit – part no.3300-0332-0A (contains mounting bracket template, two wall anchors, and two screws).
- AC Power Adapter

ASSEMBLY

1. Place the scale base on a level floor.
2. Locate the two rectangular panels in the scale base. Refer to Figure No. 1.
3. Referring to Figure No. 2, install the twelve AA-size batteries (six in each holder), noting the polarity markings located in the battery holder.



Figure No. 1



Figure No. 2

4. To install the scale base cover, place one side of the cover on one side of the scale base. See Figure No. 3.
5. Referring to Figure No. 4, slightly twist one corner of the cover and the lower remaining side onto the base.



Figure No. 3



Figure No. 4

ASSEMBLY, CONT.

- Referring to Figure No. 5, press down on the side of the cover until a clicking sound occurs indicating the cover is snapped in place.

NOTE: If necessary, tap the corners of the cover with the heel of your hand to ensure the cover snaps in place.

- The scale is now ready for operation. See Figure No. 6.



Figure No. 5



Figure No. 6

MOUNTING THE DISPLAY

The display is provided with a bracket/stand (on the back of the display) for wall mounting or use on a table or shelf. A six-foot cable allows it to be placed at a convenient position away from the scale. A wall mount kit, (part no. 3300-0332-0A) which contains a bracket mounting template, two screws, and two wall anchors is included for mounting the display on a wall.

Regardless of how and where you mount the display, it should be in a safe area where it will not be in the way of normal traffic. The location chosen should be free of temperature extremes, water, and not in direct sunlight. It should be in a location where it is easily viewed and within easy reach of the operator. If wall mounted, make certain that the wall is of sufficient strength to support the display.

Follow the instructions below to mount the display on a wall.

- Place the template from the kit against the wall and mark the holes to drill.
- Remove the template, and drill two 3/16" holes in the wall for the anchors.
- Insert the two wall anchors from the kit into the drilled holes and push them in until they are flush with the wall.
- Insert the two screws from the kit into the wall anchors and tighten them until there is approximately 1/8" (3 mm) gap between the screw head and the anchor.



Figure No. 7

- Place the large end of the slotted holes in the bracket over the screw heads, and gently pull down to secure the bracket and display to the wall.

WEIGHING UNITS SELECTION

NOTE! The following instructions apply to all models of the APEX-RI Portable Scale with Remote Indicator.

When the scale is turned on for the *first* time, it will display a prompt to select the weighing units to use for your operation, lb (pounds) or kg (kilograms). The weighing units selection can **ONLY** be made at this time and cannot be changed afterward. Make sure you select the correct weighing units before proceeding.



IMPORTANT! Make sure you select the correct weighing units. Once the weighing units has been set, it cannot be changed.



1. Press  key to turn the scale on.
2. A display test will be performed (all digits on the weight display will turn on), then change to show the software version for a few seconds, and finally, the display will change to show *SEL Un It* with the lb annunciator (factory units setting) turned on.
3. If the lb (pounds) units setting is acceptable, press the  key to save it, and then proceed to step 5.
4. Otherwise, press the  or  keys to toggle the weighing units from lb (pounds) to kg (kilograms), and then press the  key to save it.
5. The display will change to show *0.0*, with the   (ZERO), the   (STABLE) and the kg annunciator will be turned on.
6. The scale is now ready for operation.

INTERCONNECTIONS

The output connection to the scale is made on the back of the scale display. On models with the AC power adapter, the connection for the power adapter is located on the left side of the display bracket/stand.

AC Power Adapter

To power the scale using the 12V DC wall mount AC power adapter, connect the plug from the adapter to the power jack on the left side of the display bracket/stand, and then plug the power adapter into the proper electrical outlet. On models requiring 230V AC, it is the customer's responsibility to obtain the correct power adapter plug for the outlet.

USB

The USB port on the APEX-RI Portable Scale with Remote Indicator is a device (or upstream) port and uses readily available cables with the industry standard "Micro-B" connector.

The USB port may be connected to a computer for transmission of weight and associated data to a PC-based EMR (electronic medical record) software program. The data can be transmitted on demand (pressing the  key) or on receipt of a command from the computer.

RS232 COM Port

The APEX-RI Portable Scale with Remote Indicator display has one RS232 serial port on the back of the display. This port may be used to request and capture weight, send basic commands, or get diagnostics from the load cell. To use the port, an apex to PC serial cable can be purchased from the Cardinal/DETECTO Parts Department at (800) 641-2045 or parts@cardet.com. The part number is 3300-0271-0A, APEX TO PC SERIAL CABLE (9-pin, D-Sub, Female Connector).

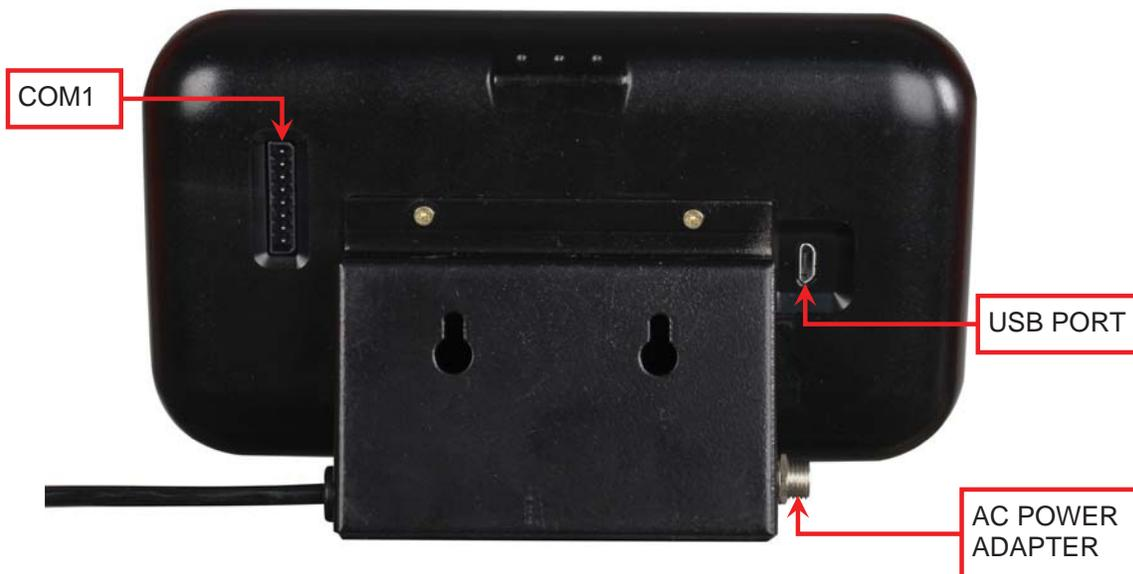

Figure No. 8

BATTERIES

The APEX-RI Portable Scale with Remote Indicator can use twelve AA-size Alkaline, Ni-Cad, or NiMH batteries (*not included*). You must first obtain and install batteries before operations can begin. Batteries are contained in two battery holders (six batteries in *each* holder) inside the scale base. Remove the scale platform cover to access the battery holders in the scale base.



NOTE: The scale can be operated from Alkaline, Ni-Cad, or NiMH batteries. All twelve batteries must be of the same type. They must all be Alkaline, all Ni-Cad, or all NiMH. **DO NOT** mix Alkaline and Ni-Cad or NiMH batteries.



CAUTION! The APEX-RI Portable Scale with Remote Indicator Scale *does not* have a battery charging circuit. Should you wish to use Ni-Cad or NiMH batteries, they must be *fully* charged before installing them. When discharged, the Ni-Cad or NiMH batteries must be removed and placed in an external charger to recharge.

Battery Status

The battery status will be displayed when batteries are installed. The battery bar graph on the display indicates the battery capacity in five steps:

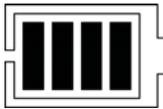

- 4 segments - the full battery capacity is available,
- 3 segments - the battery is at 80% of capacity,
- 2 segments - the battery is at 60% of capacity,
- 1 segment: - the battery is at 40% capacity.
- 0 segments - the battery is at less than 20% capacity

When the battery voltage drops too low for accurate weighing, the scale display will show $L \square$ on the small upper seven-segment display and $batt$ on the large lower seven-segment display and shut off. You will be unable to turn the scale back on until the batteries have been replaced.

Using Alkaline Batteries

When no bars are shown on the battery status symbol, press the  key to turn the scale off, remove the old batteries, and replace them with new ones.

Using NiCad or NiMH Batteries

When no bars are shown on the battery status symbol, press the  key to turn the scale off, remove the discharged batteries, and replace them with fully charged ones. Place the discharged batteries in an external charger to recharge.

Battery Saver Feature

The APEX-RI Portable Scale with Remote Indicator is equipped with a battery saver feature that helps prolong battery life by dimming the scale display backlight and turning the scale off when not in use.

Using Batteries

When using batteries, after one minute of inactivity (with no motion on the scale and no keys pressed) the scale will automatically turn off. To turn the scale back on you must press the  key. The backlight on the scale display will be at 50% brilliance to conserve battery life.

Using the AC Power Adapter

When using the AC power adapter, the automatic shut-off feature is *disabled* and the scale will remain on regardless of the length of time of inactivity. In addition, the backlight on the scale display will be at full brilliance.

BATTERIES, CONT.

Battery Installation/Replacement

To install or remove the batteries, the following steps should be followed:

1. Remove the platform cover from the scale base.
2. Referring to Figure No. 9, locate the two battery holders in the scale base.
3. If installing new batteries, proceed to step 4. If replacing the batteries, remove all twelve batteries (six in each holder) from the battery holders, and then proceed to step 4.
4. Referring to Figure No. 10, install the new twelve AA-size batteries (six in each holder), noting the polarity markings located in the battery holders.
5. After placing all twelve batteries (six in each holder), install the platform cover on the scale base, and press the  key.



Figure No. 9



Figure No. 10

6. If the display turns on, the batteries have been installed correctly. If not, remove the platform cover, and check for one or more improperly positioned batteries.
7. The scale is now ready for operation.

KEYPAD FUNCTIONS



Figure No. 11



DO NOT operate the keys with pointed objects (pencils, pens, etc.). Damage to keys resulting from this practice is NOT covered under warranty.



This is the **Power** key. With the scale off, pressing this key will apply power to the scale and turn on the display. If the scale is already on, pressing the key will turn it off.



This is the **Lock/Release** key. Press and release this key to cause the weight, height, and BMI to lock on the current values until the key is pressed again. While the scale display is locked, the annunciator resembling a padlock  will turn on to denote that the weight is being held.



This is the **Zero** key. Press and release this key to reset the display to zero. Note that when this key is pressed with weight on the scale platform, the display will zero the weight up to 100% of the scale capacity. When the weight is removed, the display will show a negative weight value. Press the  key again to reset the display to zero.



This is the **Enter/BMI** key. It is a multi-function key. First, during setup, pressing the  key will accept the currently displayed setting of the parameter. Second, the  key is used to signal the completion of the entry of data (in both setup and operation) and will cause the scale to process the data entered.

During operation, this is also the **BMI** key. It is used to input the patient's height and then perform the Body Mass Index (BMI) calculation. Note that the scale will not respond to pressing the key unless the weight is stable.

Pressing the key once allows the operator to enter a previously measured height of the patient using the  or  keys to increase or decrease to the correct height. After entering the patient's height, the display will show the Body Mass Index (BMI) calculation. After calculating the BMI, pressing this key will toggle between the patient's BMI and weight.

Note that once the patient is off the scale, the scale automatically returns to the weigh only operation mode.

KEYPAD FUNCTIONS, CONT.



This is the **MOTHER/BABY** key. It is used with the Mother/Baby Weighing feature to determine the weight of infants and toddlers held by an adult. This feature allows the adult to be weighed first, and then the adult and infant/child weighed with only the weight of the infant/child displayed.



(Up Arrow Key)

During operation, the  key is used when performing the Body Mass Index (BMI) calculation to increase the height value.

NOTE: When entering the height for BMI calculation, pressing, and holding the up arrow key  allows you to rapidly increase the height entry.

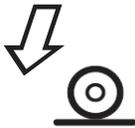

(Down Arrow/PRINT)

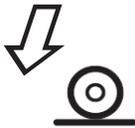
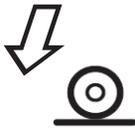
This is the **Down Arrow/PRINT** key. It serves two purposes. First, during operation, the  key is used when performing the Body Mass Index (BMI) calculation to decrease the height value. Note that when entering the height for BMI calculation, pressing, and holding the down arrow  key allows you to rapidly decrease the height entry.

Second, this is the **PRINT** key. It is used to signal the completion of the data entry, process the data entered, and send the weight and associated data to the USB port, RS232 serial port, and Wi-Fi/Bluetooth on the models APEX-RI-C and APEX-RI-C-AC.

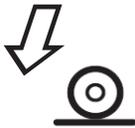
NOTE: The scale will not respond to pressing the  key unless the weight display is stable.

ANNUNCIATORS

The annunciators are displayed on the Weight screen to show that the scale is in the mode corresponding to the annunciator label or that the status indicated by the label is active.



Figure No. 12



The low battery annunciator is located in the upper left corner of the display. It is used to indicate the battery status. Refer to the Battery section of this manual for more details.

CAL (Calibration)

This annunciator is turned on when the scale is in the Setup and Calibration mode.

▲▲ (STABLE)

This annunciator is turned on when the weight display is stable. When off, it means that the change in successive weight samples is greater than the motion limits selected during setup.

→0← (ZERO)

This annunciator is turned on to indicate that the weight displayed is within +/- 1/4 division of the center of zero.

🔒 LOCK

This annunciator is turned on to show that the indicator is locked onto the displayed weight. In operation, after obtaining a stable weight, pressing the  key will cause the scale display to lock onto the weight and turn on the annunciator. Pressing the key again will unlock the display and turn off the annunciator.

BMI (Body Mass Index)

This annunciator is turned on when displaying the calculated body fat.

kg

This annunciator is turned on to indicate that the displayed weight is in kilograms.

lb

This annunciator is turned on to indicate that the displayed weight is in pounds.

cm

This annunciator is turned on when the displayed height measurement is in centimeters.

OPERATION



ALWAYS assist the patient in stepping on and off the scale platform to ensure they do not fall. **NEVER** leave a patient unattended while they are on the scale platform. Failure to maintain control of the patient at all times can result in serious injury to the patient and/or you.

Zero Weight Display

1. If the scale is not showing zero weight on the display, press the ⇨0⇩ key.
2. The Weight display will return to zero. The →0← (ZERO) and ▲▲ (STABLE) annunciators will turn on to show a stable, center-of-zero weight condition.

Basic Weighing Operation

1. Press ⏻ key to turn the scale on.
2. If required, press ⇨0⇩ key to zero weight display.
3. Assist patient onto the scale
4. When weight is stable, the ▲▲ (STABLE) annunciator will turn on.
5. The weight reading will automatically lock and the annunciator resembling a padlock 🔒 will turn on. Note that the amount of time the reading will hold is dependent upon the *HOLD* setting in Setup. **NOTE:** If more time is needed, press the 🔒⇩ key to hold the locked weight reading.
6. Read and record the weight displayed.
7. If a printer is connected to the scale, press the 🖨 key to print a ticket.
8. Assist patient off the scale.

Body Mass Index (BMI) Operation (Using Previously Measured Height)

1. Press ⏻ key to turn the scale on.
2. If required, press ⇨0⇩ key to zero weight display.
3. Assist patient onto the scale.
4. When weight is stable, the ▲▲ (STABLE) annunciator will turn on.
5. The weight reading will automatically lock and the annunciator resembling a padlock 🔒 will turn on. Note that the amount of time the reading will hold is dependent upon the *HOLD* setting in Setup. **NOTE:** If more time is needed, press the 🔒⇩ key to hold the locked weight reading.
6. Read and record the weight displayed.
7. Press the 📏 key. The display will change to the default height of 66.0 inches (168.0 cm).
8. Press ↑ or ↓ keys to increment or decrement to the correct height.
9. Press the 📏 key. The display will change to show the BMI (Body Mass Index).
10. Read and record the patient's BMI.
NOTE: While the patient is still standing on the scale, pressing the 📏 key will toggle between the patient's BMI and weight.
11. If a printer is connected to the scale, press the 📏 key again to ensure both height and weight are shown on the display, and then press the 🖨 key to print a ticket.
12. Assist patient off the scale.
13. Once the patient steps off the scale, the display automatically returns to the weight mode.

MOTHER/BABY WEIGHING



ALWAYS assist the mother alone, and when holding the baby/child in stepping on and off the scale platform to ensure they do not fall.

NEVER leave the mother or mother holding the baby/child unattended while they are on the scale platform. Failure to maintain control of the mother or mother holding the baby/child at all times can result in serious injury to the mother or mother holding the baby/child and/or you.

The Mother/Baby Weighing feature can be used to determine the weight of infants and toddlers held by an adult. Note that for accurate weighing, the child should always be weighed with the same adult whose initial weight was determined. In addition, the adult's weight should not change, for example, by removing or adding an item of clothing.

The Mother/Baby Weighing procedure is as follows:

1. Press  key to turn the scale on.
2. If required, press $\Rightarrow 0 \Leftarrow$ key to zero weight display.
3. Assist the mother on the scale.
4. When weight is stable, the  (STABLE) annunciator will turn on and the mother's weight will be displayed.
5. Press the  key.
6. The displayed weight will change to 0.0 and *m**B**B**Y* will be displayed.
7. Assist the mother off the scale.
8. After the mother is holding the baby/child, assist them back onto the scale.
9. When weight is stable, the  (STABLE) annunciator will turn on and the baby/child's weight will be displayed.
10. The weight reading will automatically lock and the annunciator resembling a padlock  will turn on.
NOTE: The amount of time the reading will hold is dependent upon the *HOLD* setting in Setup. If more time is needed, press the  key to hold the locked weight reading.
11. Read and record the baby/child's weight displayed.
12. To turn off the Mother/Baby Weighing feature, press the  key or press the  key to turn the scale off.
13. Assist the mother holding the baby/child off the scale.

SCALE SETUP

Your APEX-RI Portable Scale with Remote Indicator has been pre-configured at the factory and should not require changes for use in most applications. However, if the factory settings do not meet the requirements of your operation, the following describes the setup process.



NOTE: The keys are not to be operated with pointed objects (pencils, pens, fingernails, etc.). Damage to the keys resulting from this practice will NOT be covered under warranty.

To Enter Setup

1. Press the  key to turn the scale on.
2. The scale will perform a display test (turn on all segments and annunciators) and then change to show the software version.
3. With the software version displayed, press, and hold the $\Rightarrow 0 \Leftarrow$ key.
4. The display will change to show the $\llcorner RP$ prompt, the current Scale Capacity setting, and turn on the CAL (calibration annunciator).
5. The scale is now ready for setup and calibration.

In Setup, the current setting prompt will be shown in the smaller upper seven-segment display, while the value of the current setting will be shown in the large lower seven-segment display. Note that when moving through the setup prompts, the default or previously selected value appears first on the display.

Setup Navigation Keys



This is the **Enter** key. Press the  key to accept the currently displayed setting of the parameter and advance to the next setup prompt.



This is the **Lock/Release** key. Press the  key to return to the previous setup prompt.



(Arrow Keys)

These keys are used when selecting setup values. Pressing the \Uparrow or \Downarrow keys will increase or decrease the value of the selected parameter or toggle between the available parameter values.

Each press of the \Uparrow key will increase the displayed setup parameter value by one step or toggle between available values.

Each press of the \Downarrow key will decrease the displayed setup parameter value by one step or toggle between available values.

NOTE: When entering the scale capacity ($\llcorner RP$) and calibration load value ($\llcorner RLd$) pressing and holding the arrow keys allow you to rapidly increase, or decrease the displayed setup parameter value.

SCALE SETUP, CONT.

CAP (SCALE CAPACITY)

The display will show *CAP* and the current setting. If the value displayed is acceptable, press the  key. Otherwise, press the  or  keys to select a new value and then press the  key to save it and proceed to the next prompt.

This is the maximum allowed weight on the scale. It should be set to 600.0.

Int (INTERVAL SETTING)

The display will show *Int* and the current setting. If the value displayed is acceptable, press the  key. Otherwise, press the  or  keys to select a new value and then press the  key to save it and proceed to the next prompt.

This is the minimum graduation of the scale. Allowable settings are 1, 2, or 5.

dEC (DECIMAL POINT POSITION)

The display will show *dEC* and the current setting. If the value displayed is acceptable, press the  key. Otherwise, press the  or  keys to select a new value and then press the  key to save it and proceed to the next prompt.

This is the decimal point precision of the scale. Allowable settings are 0, 1, 2, or 3.

0 = XXXXX 1 = XXXX.X 2 = XXX.XX 3 = XX.XXX

SR (SAMPLE RATE)

The display will show *SR* and the current setting. If the value displayed is acceptable, press the  key. Otherwise, press the  or  keys to select a new value and then press the  key to save it and proceed to the next prompt.

This is the number of times per second the load cell is sampled. Allowable values are a minimum of 1 sample per second to a maximum of 10 samples per second in one sample per second intervals.

FILT (DIGITAL FILTER MODE)

The display will show *FILT* and the current setting. If the value displayed is acceptable, press the  key. Otherwise, press the  or  keys to select a new value, and then press the  key to save it and proceed to the next prompt.

This is the amount of digital filtering applied to the scale. Allowable settings are 0, 1, 2, or 3.

0 = Off 1 = Minimal 2 = Moderate 3 = Maximum

MOt (MOTION RANGE)

The display will show *MOt* and the current setting. If the value displayed is acceptable, press the  key. Otherwise, press the  or  keys to select a new value, and then press the  key to save it and proceed to the next prompt.

The motion range is the number of divisions of change permitted before indicating unstable (the STABLE annunciator turns off). Allowable values are 1 to 10.

SCALE SETUP, CONT.

EUR0 (OIML)

This setting controls the OIML (European) specific requirements.

The display will show *EUR0* and the current setting. If the value displayed is acceptable, press the  key. Otherwise, press the  or  keys to toggle the OIML selection between *YES* or *no*, and then press the  key to save it and proceed to the next prompt.

Allowable settings are *YES* for the EU or *no* for the US.

PUD (Power Up Zero)

The display will show *PUD* and the current setting. If the value displayed is acceptable, press the  key. Otherwise, press the  or  keys to toggle the power up zero between *YES* or *no*, and then press the  key to save it and proceed to the next prompt.

This setting controls zeroing of the scale on power up. If enabled, the scale will be reset to zero automatically on power up. Allowable settings are *YES* or *no*.

0tr (Zero Tracking)

The display will show *0tr* and the current setting. If the value displayed is acceptable, press the  key. Otherwise, press the  or  keys to select a new value, and then press the  key to save it and proceed to the next prompt.

This setting controls the automatic zero tracking of the scale. Allowable values are 0 to 10, indicating the number of half-divisions above or below zero that the scale will attempt to maintain the zero position. **NOTE:** Select 0 (zero) to disable zero tracking.

Ser 1 (Com1 Mode)

The display will show *Ser 1* and the current setting. If the value displayed is acceptable, press the  key. Otherwise, press the  or  keys to toggle the Com1 Mode between *Cont* (continuous output), *POLL* (weight on demand), and *SPot* (Welch-Allyn Spot LXi interface), then press the  key to save it and proceed to the next prompt.

This setting controls the output for Com 1. Allowable settings are *Cont*, *POLL*, or *SPot*.

If *Cont* (continuous output) was selected for Com 1, the scale will continuously transmit weight data.

If *POLL* (Weight-On-Demand) was selected for Com 1, and the scale is connected to a computer for transmission of weight data to a PC-based EMR (electronic medical record) software program, it will transmit a single set of weight data each time the computer sends a weight request "ENQ" (hex 05) or an SMA weight request "W".

If *SPot* (Welch-Allyn Spot LXi interface) was selected for Com 1, the scale will automatically interface to a Welch-Allyn Spot LXi interface device to transmit weight data.

SCALE SETUP, CONT.

USB (USB Mode)

The display will show *USB* and the current setting. If the value displayed is acceptable, press the  key. Otherwise, press the  or  keys to toggle the USB Mode between *PHdC* (Personal Healthcare Device Class), *Cont* (continuous output), or *POLL* (weight on demand) and then press the  key to save it and proceed to the next prompt.

This setting controls the output for the USB device port. Allowable settings are *PHdC*, *ALLYN*, or *SMA*.

If *PHdC* (Personal Healthcare Device Class) was selected for USB, the scale will transmit data using the CEN ISO/IEEE 11073 Medical / Health Device Communication Standard.

If *ALLYN* (Welch Allyn) was selected for USB, the scale will automatically transmit data to a Welch Allyn CVSM Device when the weight on the scale stabilizes and the  (STABLE) annunciator turns on. (Requires device to have an activated license. Must purchase DETECTO WACONNECT)

If *SMA* (SMA, Weight-On-Demand) was selected for USB, and the scale is connected to a computer for transmission of weight data to a PC-based EMR (electronic medical record) software program, it will transmit a single set of weight data each time the computer sends a weight request "ENQ" (hex 05) or an SMA weight request "W".

YEAR (YEAR)

The display will show *YEAR* and the current setting. If the value displayed is acceptable, press the  key. Otherwise, press the  or  keys to select a new value, and then press the  key to save it and proceed to the next prompt.

This is the current year setting of the real-time clock. Allowable values are from 2015 to 2099.

MONTH (MONTH)

The display will show *MONTH* and the current setting. If the value displayed is acceptable, press the  key. Otherwise, press the  or  keys to select a new value, and then press the  key to save it and proceed to the next prompt.

This is the current month setting of the real-time clock. Allowable values are 1 to 12.

1 = January	4 = April	7 = July	10 = October
2 = February	5 = May	8 = August	11 = November
3 = March	6 = June	9 = September	12 = December

DAY (DAY)

The display will show *DAY* and the current setting. If the value displayed is acceptable, press the  key. Otherwise, press the  or  keys to select a new value, and then press the  key to save it and proceed to the next prompt.

This is the current day setting of the real-time clock. Allowable values are 1 to 31.

SCALE SETUP, CONT.

HOUR (HOUR)

The display will show *HOUR* and the current setting. If the value displayed is acceptable, press the  key. Otherwise, press the  or  keys to select a new value, and then press the  key to save it and proceed to the next prompt.

This is the current hour setting of the real-time clock. Allowable values are 0 to 23.

NOTE: The hour is entered in a 24-hour format. When entering the hour after noon, you must add 12 to the time. For example, 3:00 PM would be entered as 15.

MIN (MINUTE)

The display will show *MIN* and the current setting. If the value displayed is acceptable, press the  key. Otherwise, press the  or  keys to select a new value, and then press the  key to save it and proceed to the next prompt.

This is the current minute setting of the real-time clock. Allowable values are 0 to 59.

SEC (SECONDS)

The display will show *SEC* and the current setting. If the value displayed is acceptable, press the  key. Otherwise, press the  or  keys to select a new value, and then press the  key to save it and proceed to the next prompt.

This is the current seconds setting of the real-time clock. Allowable values are 0 to 59.



NOTE: The following two parameters are not used with the apex-RI series. Press the  key to save the current setting and proceed to the next prompt.

HtCl (Sonar Height Calibration)

The display will show *HtCl* and the current setting *no*. Press the  key to save the current setting and proceed to the next prompt.

S Ht (SENSOR HEIGHT)

The display will show *S Ht* and the current setting. Press the  key to save the current setting and proceed to the next prompt.

HOLD (HOLD TIME)

This setting is used by the scale to hold a stable patient weight for a desired amount of time. For example, if a value of 5 seconds is used, then when the scale locks onto a stable patient weight, it will remain locked for 5 seconds before automatically releasing the weight.

The display will show *HOLD* and the current setting. If the value displayed is acceptable, press the  key. Otherwise, press the  or  keys to select a new value, and then press the  key to save it and proceed to the next prompt.

This setting controls the auto-locking feature. Allowable values for hold time are 0 to 20.

SCALE SETUP, CONT.

CAL (CALIBRATION)

The display will show *CAL* and the current setting *no*. If the scale has been previously calibrated and you wish to skip calibration and proceed to the *TYPE* (Scale Model) prompt, press the  key and the previous calibration will be retained.

To begin calibration, press the  key to select YES and then press the  key. After pressing the  key, the display will change to *LOAD*.

LOAD (LOAD CALIBRATION WEIGHT)

With the display showing *LOAD*, perform the following steps:

1. Make certain the scale platform is empty and free of debris.
2. Place the desired amount of calibrated test weights on the scale platform. A minimum of 50% of the scale's capacity is required. However, 70% to 100% is recommended.
3. Press the  key.
4. If the value displayed is acceptable, press the  key again. Otherwise, determine the exact amount of test weight placed on the scale platform, and then using the  or  keys select the test weight amount.
5. Verify that the numbers selected are the same as the amount of the test weight and then press the  key.
6. Starting at the left and preceding right, a series of dashes will appear on the display. The dashes will stay on the display momentarily, then disappear, after which the display will proceed to the next prompt.

UNLOAD (UNLOAD CALIBRATION WEIGHT)

After a moment, the display will change to *UNLOAD*.

1. Remove the test weights from the scale platform and then press the  key.
2. Starting at the left and preceding right, a series of dashes will appear on the display. The dashes will stay on the display momentarily, then disappear, after which the calibration factor will be saved and the display will proceed to the next prompt.



IMPORTANT: During the time the dashes appear on the display, ensure that the loaded (or empty) scale is stable.

GRAV (Gravity Compensation)

Gravity compensation accounts for latitudes and elevations that are different from where the scale was calibrated. To calculate the value for this parameter, use the gravitational constant of the location where the scale was calibrated divided by the gravitational constant of where the scale will be installed:

$$\frac{\text{Gravitational Constant (Calibration location)}}{\text{Gravitational Constant (Operation location)}} = \text{value}$$

This should give you a value close to 1 that you can enter to compensate for variation in gravity due to elevation/latitude.

The display will show *GRAV* and the current setting. If the value displayed is acceptable, press the  key. Otherwise, press the  or  keys to select a new value, and then press the  key to save it and proceed to the next prompt.

Allowable values for *GRAV* are 0.000 to 2.000.

NOTE: The default value is 1.000, which means there is no gravity compensation.

SCALE SETUP, CONT.

LDn9 (Factory Use Only)

The display will show *LDn9* and the current setting. This setting is for factory use only and must always be set to *no*.



IMPORTANT! If the setting for *LDn9* is *YES*, press the \uparrow or \downarrow keys to change it to *no*, and then press the \leftarrow key to save it and proceed to the next prompt.

tYPE (Scale Model)

The display will show *tYPE* and the current setting. If the value displayed is acceptable, press the \leftarrow key. Otherwise, press the \uparrow or \downarrow keys to toggle the Scale Model between *APEx* (apex®) or *CUSt* (custom, not applicable at this time), and then press the \leftarrow key to save it. You will be returned to the *CRP* prompt, the current Scale Capacity setting.

This will change the default settings and operation of the scale. For instance, select *APEx* for the type to use the stand-up type scale for the scale with the inline height rod or sonar height rod.

Allowable settings are *APEx* or *CUSt*.



NOTE: If your scale is the Model apex-RI-C, additional setup prompts will be shown after selecting the *tYPE* setting.

Proceed to the Model apex-RI-C section of this manual for guidance through the setup and operation of the Wi-Fi and Bluetooth (BLE) wireless transmitter features. Otherwise, setup and calibration are complete.

Setup and Calibration are Complete

Now that setup and calibration have been completed, press the ⏻ key to turn the scale off, and then press it again to turn the scale back on. The scale is now ready for normal operation.

DATA FORMAT

Cont (Continuous Output)

If *Cont* (continuous output) is selected, the scale will continuously transmit weight data in SMA format (see below).

POLL (Weight-On-Demand)

If *POLL* (Weight-On-Demand) is selected and the scale is connected to a host device (computer) for transmission of weight data to a PC-based EMR (electronic medical record) software program, it will transmit a single set of weight data each time the host device (computer) sends an SMA weight request "W" or a weight request "ENQ" (hex 05). An example and explanation of the data format transmitted are shown below.

SMA Format (*Cont* or *POLL*)

This format is used if the scale is configured for *Cont* (continuous output) OR if the scale is configured for *POLL* (weight-on-demand) and the host device (computer) sends:

<LF>W<CR>

or

<ENQ> (hex 05)

The scale will respond with the following SMA weight string:

<LF><S><R><N><M><SPACE>XXXXXXXX.X<UUU><CR>

Where:

LF =	Line Feed	Line feed character (hex 0A)
S =	Status	O = Over Cap, Z = Center Zero, U = Below Zero, E = Error
R =	the number 1	
N =	Mode of operation	G = Gross, N = Net, T = Tare
M =	Motion bit	M = Motion, Blank = Stable (no motion)
XXXXXXXX.X =	Weight	Weight with a decimal point if necessary
UUU =	Unit	lb or kg
CR =	Carriage Return	Carriage Return (hex 0D)

WI-FI AND BLUETOOTH LOW ENERGY (BLE)

The APEX-RI Portable Scale with Remote Indicator models APEX-RI-C and APEX-RI-C-AC have a wireless transmitter inside the weight display that has been designed for an environment where interfacing the scale to a Wi-Fi network or pairing to a Bluetooth-capable device is desired. The following sections will guide you through the setup and operation of the Wi-Fi and Bluetooth Low Energy (BLE) features of the scale.

Wi-Fi Features

- Soft Access Point (AP) for setting credentials for the Wi-Fi module
- Setup option to select a static or dynamic IP address
- Built-in web server to display weight, height, and BMI
- TCP/IP connection for continuous output of weight, height, and BMI

WI-FI SETUP

Enable and Configure Wi-Fi Networking

NOTE: Default network settings are $WFI = OFF$, $BLE = OFF$, and $DHCP = On$.

1. Press the  key to turn the scale on.
2. Press and hold the  keys until the display shows the prompt CRP .
3. Press the  key until the prompt WFI is displayed. Use the  or  keys to change the selection to On and press the  key.
4. The prompt will change to $DHCP$. Press the  or  keys until the correct setting is displayed, and then press the  key.
NOTE: Select OFF to use a static IP address or select On to use a dynamic IP address assigned by a DHCP server. Consult your network administrator for the proper selection.
5. The next prompt will be $IP1$, the first octet of the static IP address.
 - a. If $DHCP$ was set to On , press the  key until the prompt YCL is displayed.
 - b. If $DHCP$ was set to OFF , press the  or  key until the correct setting for the first octet of the static IP address is displayed, and then press the  key. For example, if the static IP address is "192.168.0.2", press the  or  key until the display shows 192, and then press the  key. Repeat this procedure for the remaining three octets of the static IP address, $IP2$, $IP3$, and $IP4$.
6. The next prompt will be $Sub1$, the first octet of the network subnet mask.
 - a. If $DHCP$ was set to On , press the  key until the prompt YCL is displayed.
 - b. If $DHCP$ was set to OFF , press the  or  key until the correct setting for the first octet of the network subnet mask is displayed. Press the  key. Repeat this procedure for the remaining three octets of the network subnet mask, $Sub2$, $Sub3$, and $Sub4$.
7. The next prompt will be $Gate1$ for the first octet of the network gateway's IP address.
 - a. If $DHCP$ was set to On , press the  key until the prompt YCL is displayed.
 - b. If $DHCP$ was set to OFF , press the  or  key until the correct setting for the first octet of the network gateway's IP address is displayed. Press the  key. Repeat this procedure for the remaining three octets of the network gateway's IP address, $Gate2$, $Gate3$, and $Gate4$.
8. The display will prompt YCL . This is the prompt to clear the Wi-Fi credentials (SSID and password).
 - a. To clear the credentials, press the  or  key until YES is displayed, and then press the  key. The credentials will be *cleared* and the display will change to show CRP .
 - b. To retain the credentials, press the  or  key until NO is displayed, and then press the  key. The credentials will be *retained* and the display will change to show CRP .
9. Press the  key to turn the scale off and then press it again to turn the scale back on.
10. Proceed to the Configure Wi-Fi Network Module section.

WI-FI SETUP, CONT.

Configure Wi-Fi Network Module

Without Wi-Fi credentials, the Wi-Fi module will enter listening mode, in which it functions as a Wi-Fi access point. The SSID of the AP is in the form of "REDBIRD_WIFI_XX:XX", where XX:XX is the last 4 digits of the MAC address. Use a Wi-Fi device, such as a Smartphone, tablet, or laptop to connect to the apex scale. If the connection fails, try moving the scale to another location or cycling power to the scale.

When the connection has been made, open a web browser, and go to the location **redbird.com**. The "Configure Wi-Fi" page should appear.



The screenshot shows a mobile browser interface. At the top, the time is 2:54 and the address bar shows "redbird.com/?refresh=S". The main content area features the "Cardinal DETECTO" logo and the heading "Configure Wi-Fi". Below this are three input fields: "Network Name", "Password", and "Device Name". A red "Connect" button is positioned below the input fields. Further down, there is a section titled "Available Networks" with a red "Scan" button. Below the "Scan" button is a table with three columns: "SSID", "Mac Address", and "Signal Strength".

SSID	Mac Address	Signal Strength
BLUEROOM	54:75:D0:B3:0D:AF	-51
Dynex617	10:DA:43:82:56:2C	-52

Click on the **Scan** button to see a list of available Wi-Fi networks.

WI-FI SETUP, CONT.

Configure Wi-Fi Network Module, Cont.



2:55

redbird.com/?refresh=S

Cardinal
DETECTO

Configure Wi-Fi

Network Name
Dynex617

Password
.....

Device Name
apex scale

Connect

Available Networks **Scan**

SSID	Mac Address	Signal Strength
BLUEROOM	54:75:D0:B3:0D:AF	-51
Dynex617	10:DA:43:82:56:2C	-52

Enter the Network Name (SSID), Password, and Device Name (optional) for the network you wish to connect to. Note that the Device Name can be anything. Click on the **Connect** button and the module should try to connect to that network. This may take several seconds. The module will store these network credentials and connect to this network each time the scale is turned on.

Changing the Network Credentials

To change the network credentials, perform the following steps:

1. Press the  key to turn the scale on.
2. Press and hold the  **0**  keys until the display shows the prompt *CRP*.
3. Press the  key until the prompt *Y CL* is showing.
4. Next, press the  or  key until *YES* is displayed, and then press the  key. The credentials will be *cleared* and the display will change to show *CRP*.
5. Press the  key to turn the scale off and then press it again to turn the scale back on.
6. Repeat the steps in the previous paragraph to set the new network credentials.

WI-FI OPERATION

Web Server

While the scale is connected to a network you can access the hosted web page. To view the web page, proceed to the IP address of the Redbird module with “/webserver.html” added to it. For example, if the IP address is “192.168.0.5”, enter **192.168.0.5/webserver.html**, and a page like the following should appear.



WI-FI OPERATION, CONT.

TCP/IP Connection

Continuous output is available by TCP/IP connection to the scale's IP address at port 10001.

- The scale will transmit a single set of weight data each time the SMA weight request <LF>W<CR> is received.
- Each time the SMA weight request <LF>R<CR> is received, the scale will transmit weight data continually until another SMA command is received.

SMA format for both command <LF>W<CR> and <LF>R<CR>.

<LF><s><r><n><m><f><xxxxxx.xxx><uuu><CR>

Where:

LF =	Line feed (hex 0A) = Start of response message
s =	Scale Status definition
	Z = Center of Zero <xxxxxx.xxx>= 0.000
	O = Over Capacity <xxxxxx.xxx>= +weight
	U = Under Capacity <xxxxxx.xxx>= -weight
	E = Zero Error (clears when the condition clears)
	<space> = None of the above conditions NOTE: For "E" error condition <xxxxxx.xxx>= _____ (center dashes) and "Z", "O", and "U" are overridden
r =	Range ("1", "2", "3", etc.) always "1" for a single range
n =	Mode of Operation (Gross/Net status)
	G = Gross normal weight
	T = Tare weight (in response to "M" command)
	N = Net normal weight
	g = gross weight in high-resolution
	n = net weight in high-resolution
m =	Motion status
	M = Scale in Motion
	<space> = Scale not in Motion
f =	Future = Reserved for future or custom use
xxxxxx.xxx =	Weight with a decimal point if necessary
uuu =	Units = lb or kg
CR =	Carriage Return (hex 0D) = End of response message

SMA Commands

Once a TCP/IP connection has been made to the apex scale, you can issue SMA commands to it. The apex scale will respond to the SMA commands in the format shown in the Response column of the WI-FI AND BLUETOOTH SMA COMMANDS table on pages 31 and 32 of this manual.

BLUETOOTH LOW ENERGY (BLE)

The APEX-RI Portable Scale with Remote Indicator models APEX-RI-C and APEX-RI-C-AC have a wireless transmitter inside the weight indicator enclosure that can be configured for Bluetooth Low Energy (BLE). When possible, BLE standard specifications are used (those that are adopted by the Bluetooth SIG). Custom services were created to request indicator and scale information whose communication protocol was developed by the Scale Manufacturers Association (SMA).

Features Available via BLE

- Device Information Service
 - Manufacturer Name
 - Model Number
 - Software Revision
- Battery Service
 - Battery Level Percentage
- Weight Scale Service
 - Weight Measurement
 - Weight Scale Feature
- Custom Services
 - DETECTO SMA Service

Enable Bluetooth (BLE) Networking

NOTE: Default network settings are $Y F I = OFF$, $bLE = OFF$, and $dHCP = On$.

1. Press the  key to turn the scale on.
2. Press and hold the $\Rightarrow 0 \Leftarrow$ keys until the display shows the prompt CRP .
3. Press the  key until the prompt bLE is displayed.
4. Use the \uparrow or \downarrow keys to change the selection to On and press the  key.
5. Press the  key to turn the scale off and then press it again to turn the scale back on.
6. The scale is now ready to pair with a Bluetooth-capable device.



IMPORTANT! If an attempt is made to turn the Bluetooth (BLE) off when a device is connected to the scale, the display will show the error message bLE (in the smaller upper seven-segment display) and $E - OFF$ (in the large lower seven-segment display). This message will be shown until a key is pressed. Note that at this time, the Bluetooth (BLE) is still on, only the message has been cleared. To turn the Bluetooth (BLE) off, the device must be disconnected from the scale or the scale must be turned Off and back On.

Bluetooth Pairing

To pair a Bluetooth-capable device with the scale, select the name of the scale from the list of available connections: Apex Scale XX:XX:XX:XX:XX:XX. Note that the Xs represent the MAC address of the BLE wireless transmitter in the scale weight indicator.

NOTE: If there are multiple apex scales nearby, hold down the  key until the scale software revision is shown. The display will then show the event counters, the Redbird ($r b r$) software revision for the Wi-Fi and Bluetooth (BLE) module, and then scroll the Bluetooth (BLE) advertisement data across the display. Note that the colons between the MAC addresses will not be shown.

When a stable reading is achieved, and the scale is paired with a Bluetooth-capable device, the reading will transmit when the connected device sends a request to receive data.

INTERFACING TO BLE

NOTE: 16-bit (4-digit) UUIDs are adopted standards. 128-bit (32-digit) UUIDs are custom services or characteristics.

Standard Services per Bluetooth SIG

Reference adopted specifications at <https://www.bluetooth.com/specifications/gatt>.

Device Information Service (0x180A)

Characteristics	Number	Value(s)	Attributes
Manufacturer Name String	0x2A29	“Detecto”	READ
Model Number String	0x2A24	“Apex-C”	READ
Software Revision String	0x2A28	“1.0.XX” software of scale	READ

Battery Service (0x180F)

Characteristics	Number	Value(s)	Attributes
Battery Level	0x180F	0x00 – 0x64 (uint16), represents 0 – 100 percent	READ

Weight Scale Service (0x181D)

Characteristics	Number	Value(s)	Attributes
Weight Measurement	0x2A9D	<8bit Flag><uint16 weight><uint16 bmi><uint16 ht> Supported Flags: Flag bit0: 0 = SI, 1 = Imperial bit3: 0 = BMI and Height not present 1 = BMI and Height present bit4: 0 = Not below zero* 1 = Below zero* SI: Wt is KG with resolution 0.0005 Ht is meters with resolution 0.001 Imperial: Wt is lbs with resolution 0.01 Ht is inches with a resolution 0.1	READ INDICATE
Weight Scale Feature	0x2A9E	NOT YET IMPLEMENTED	

- * • If the weight is below zero (0), the weight you will see is zero (0).
- If the weight is below zero (0), bit 4 of Weight Measurement will be set to 1, otherwise bit 4 is set to zero (0).

NOTE: The maximum weight value displayed is 655.35 in both pounds (lb) and kilograms (kg).

BLUETOOTH INTERFACE STANDARD PROTOCOLS

Bluetooth Characteristic – Weight_Measurement: 0x2A9D

Widely accepted BLE GATT profiles are used to transmit data to other devices/software that have implemented these profiles. Data is passed via BLE using GATT characteristic “Weight Measurement” (0x2A9D) as defined by Bluetooth SIG. Refer to the data table below about Weight Measurement Characteristics.

Weight_Measurement: 0x2A9D

NAMES	FIELD REQUIREMENTS	FORMAT	MIN. VALUE	MAX. VALUE	ADDITIONAL INFORMATION									
					BIT FIELD									
				Bit	Size	Name	Definition		Requires					
						Key	Value							
Flags	Mandatory	8 bit	N/A	N/A	0	1	Measurement Units	0	SI (Weight and Mass in Units of Kilogram (kg) and Height in Units of Meter)	C1				
								1	Imperial (Weight and Mass in Units of Pound (lb) and Height in Units of inch (in))	C2				
							1	1	Time Stamp Present	0	False			
										1	True	C3		
							2	1	User ID Present	0	False			
										1	True	C4		
							3	1	BMI and Height Present	0	False			
										1	True	C5		
4	1	Below Zero	0	Not Below Zero										
			1	Below Zero										
Weight - SI	C1	uint16	N/A	N/A	Information: Unit is in kilograms with a resolution of 0.005 and is determined when bit 0 of the Flags field is set to 0. Unit: org.bluetooth.unit.mass.kilogram Exponent: Decimal, -3 Multiplier: 5									
Weight - Imperial	C2	uint16	N/A	N/A	Information: Unit is in pounds with a resolution of 0.01 and is determined when bit 0 of the Flags field is set to 1. Unit: org.bluetooth.unit.mass.pound Exponent: Decimal, 02.									
Time Stamp	C3		N/A	N/A	Information: Smallest unit in seconds Unit: org.bluetooth.characteristic.date.time									
User ID	C4	uint8	N/A	N/A	The special value of 0xFF (255 Decimal) for User ID represents "unknown user". Information: Unit is unitless with a resolution of 1 <table border="1" style="margin-left: 20px;"> <thead> <tr> <th>Key</th> <th>Value</th> </tr> </thead> <tbody> <tr> <td>255</td> <td>Unknown user</td> </tr> </tbody> </table> Unit: org.bluetooth.unit.unitless Exponent: Decimal, 0						Key	Value	255	Unknown user
Key	Value													
255	Unknown user													
BMI	C5	uint16	N/A	N/A	Information: Unit is unitless with a resolution of 0.1 Unit: org.bluetooth.unit.unitless Exponent: Decimal, -1									
Height - SI	C1 C5	uint16	N/A	N/A	Information: Unit is in meters with a resolution of 0.001 and is determined when bit 0 of the Flags field is set to 0. Unit: org.bluetooth.unit.length.meter Exponent: Decimal, -3									
Height - Imperial	C2 C5	uint16	N/A	N/A	Information: Unit is in inches with a resolution of 0.1 and is determined when bit 0 of the Flags field is set to 1. Unit: org.bluetooth.unit.length.inch Exponent: Decimal, 0-1									

BLUETOOTH INTERFACE STANDARD PROTOCOLS, CONT.

Custom Services

DETECTO SMA Service (0x907a0000-8699-47dd-ab30-d7aad5f83e54)

All custom characteristics have the same base number of the Service UUID 0x907aXXXX-8699-47dd-ab30-d7aad5f83e54 where the XXXX part distinguishes the service.

Characteristics	Sub Number	Value(s)	Attributes
Rx Cmd	0001	SMA string received by scale (up to 20 chars)	WRITE
Tx Cmd	0002	SMA string sent by scale (up to 20 chars)	NOTIFY

SMA Commands

The SMA commands shown in the WI-FI AND BLUETOOTH SMA COMMANDS table on pages 31 and 32 of this manual can be sent using the DETECTO SMA Service's Rx Cmd characteristic (0x907a0001-8699-47dd-ab30-d7aad5f83e54).

Responses will put out a notification on the Tx Cmd characteristic (0x907a0002-8699-47dd-ab30-d7aad5f83e54).

WI-FI AND BLUETOOTH SMA COMMANDS

The format used to send SMA commands to the APEX-RI-C and APEX-RI-C-AC scale is:

<LF>command<CR>

Where “command” is the ASCII letter(s), or the Hex Rep. listed in the table below. For example, <LF>Z<CR> or <LF>0A5A0D<CR> would send the command to zero the scale. Note that the response of each command is listed under the Response column of the table.



Any invalid command sent will return a *question mark* for a response. For example, sending a <LF>XZ<CR> will return 0A 3F 0D (<LF>?<CR>).

Command	Hex Rep.	Response
Z – zero scale	0A5A0D	None. You should see scale zero itself.
D – scale diagnostics	0A440D	0A 20 20 20 20 0D = means there are no errors, EEPROM error will show an E in the second space and C will show in the third space if there is a calibration error. 20 = SPACE
W – request weight	0A570D	0A 5A 31 47 20 20 30 30 30 30 30 2E 30 30 6C 62 0D = Z1G 000000.00lb
H – request high resolution weight	0A480D	0A 5A 31 67 20 20 30 30 30 30 30 2E 30 31 6C 62 0D = Z1g 000000.01lb
A – about scale first line	0A410D	0A 53 4D 41 3A 32 2F 31 2E 31 0D = SMA:2/1.1
B – about scale scroll	0A420D	Each time sent you will get the next line of information until there is no longer any information. 1. 0A 4D 46 47 3A 44 65 74 65 63 74 6F 0D = MFG:Detecto 2. 0A 4D 46 44 3A 41 70 65 78 2D 43 0D = MOD:Apex-C 3. 0A 52 45 56 3A 58 2E 58 2E 58 58 0D = REV:X.X.XX 5. 0A 45 4E 44 3A 0D = END: 6. If B is sent again you will get the unknown command response until the A command is sent again. 0A 3F 0D = ?
I – scale information	0A490D	0A 53 4D 41 3A 32 2F 31 2E 31 0D = SMA:2/1.1

WI-FI AND BLUETOOTH SMA COMMANDS, CONT.

Command	Hex Rep.	Response
N – scale information scroll	0A4E0D	<p>Each time sent you will get the next line of scale information until there is no longer any information.</p> <p>1. 0A 54 59 50 3A 53 0D = TYP:S</p> <p>2. 0A 43 41 50 3A 20 6C 62 3A 36 30 30 2E 30 3A 32 3A 31 0D = CAP: lb:600.0:2:1, this depends on the settings of the Apex. 600.0 – Capacity, 2 – Interval, & 1 – Decimal</p> <p>3. 0A 43 4D 44 3A 48 52 49 4E 58 0D = CMD:HRINX</p> <p>4. 0A 45 4E 44 3A 0D = END:</p> <p>5. If N is sent again you will get the unknown command response until the I command is sent again. 0A 3F 0D = ?</p>
R – Repeat Displayed Weight Continuously	0A520D	<p>0A 5A 31 47 20 20 30 30 30 30 30 30 2E 30 30 6C 62 0D = Z1G 000000.00lb, you should get this continuously until another SMA command is received.</p>
XB – battery level percentage	0A58420D	<p>0A 38 36 2E 32 35 0D = 86.25</p>

PRINTING ON STABLE WEIGHT

Printing of data when the weight is stable is supported.



ALWAYS assist the patient in stepping on and off the scale platform to ensure they do not fall. **NEVER** leave a patient unattended while they are on the scale platform. Failure to maintain control of the patient at all times can result in serious injury to the patient and/or you.

1. Assist the patient on the scale.
2. When weight is stable, the  (STABLE) annunciator will turn on.
3. The weight reading will automatically lock and the annunciator resembling a padlock  will turn on. Note that the amount of time the reading will hold is dependent upon the *HOLD* setting in Setup. **NOTE:** If more time is needed, press the  key to hold the locked weight reading.
4. Press the  key.
5. The scale will then send an output string consisting of the Date, Time, Weight, Height, and BMI with units for weight and height.
Example data string: 05/21/19,09:48,181.1lb,70.9in,25.5
6. Assist the patient off the scale.

EVENT COUNTER

Your APEX-RI Portable Scale with Remote Indicator has been designed with an Event Counter type of security seal. When selected, the scale will display two numbers representing the Calibration and Configuration counters.

Calibration Counter (CAL)

The calibration counter is incremented when a value in the calibration part of the setup is changed (CAL, UNIT, DEC, SR, FFLT, MODE, URD, CAL, GRAD, LONG, and TYPE). The counter is only incremented 1 time even if more than one parameter is changed in setup.

Configuration Counter (CFG)

The configuration counter is incremented when a value in the configuration part of the setup is changed (PUO, OTr, SER1, SER2, USb, YEAR, MONTH, DAY, HOUR, MIN, SEC, S Ht, Hold). The counter is only incremented 1 time even if more than one parameter is changed in setup.

To Review the Event Counter:

1. Press the  key to turn the scale on.
2. The scale will perform a display test (turn on all segments and annunciators), and then change to show the software revision for a few seconds.
3. Next, the display will change to the Weight Display with the $\rightarrow 0 \leftarrow$ (ZERO) and $\blacktriangle \blacktriangle$ (STABLE) annunciators turned on to show a stable, center-of-zero weight condition.
4. Press and hold the  key.
5. The display will change to show all dashes and then the software revision.
6. Release the  key.
7. The display will change to show CAL (Calibration Counter) on the small upper seven-segment display and up to a 3-digit number on the large lower seven-segment display for approximately two seconds.
8. Next, the display will show CFG (Configuration Counter) on the small upper seven-segment display and up to a 3-digit number on the large lower seven-segment display for approximately two seconds and then change to show all dashes.



NOTE: If your scale is the model APEX-RI-C or APEX-RI-C-AC, additional information for the Wi-Fi and Bluetooth (BLE) settings will be shown after the Configuration Counter. Refer to the next section, Display Scale Wi-Fi and Bluetooth Settings for additional information and instructions.

9. To return to normal operation, press the  key or press the  key to turn off the scale.

DISPLAY SCALE WI-FI AND BLUETOOTH SETTINGS

If your scale is the model APEX-RI-C or APEX-RI-C-AC, additional settings will be shown after the calibration and configuration counters have been shown.

To display the Wi-Fi and Bluetooth Settings, follow the steps below:

1. With no weight on the scale, press and hold the  key for approximately 5 seconds.
2. The display will show height for a short time, and then change to show the software revision of the scale for a few seconds.
3. Release the  key.
4. The display will change to show the Calibration Counter (CAL) for approximately two seconds and then the Configuration Counter (CFG) for approximately two seconds.
5. Next, the Redbird (rbr) software revision for the Wi-Fi and Bluetooth (BLE) module will be displayed.
6. If Wi-Fi is enabled (WiFi = On), the following will be shown:
 - a. The Wi-Fi status Connected or Disconnected (connect or disconnect) will be displayed.
 - b. The four octets¹ of the static IP address for the scale will be shown.
 - c. The network name (SSID) will be shown.
7. After that, the Bluetooth (BLE) advertisement data Apex Scale XX:XX:XX:XX:XX:XX will scroll across the display. Note that the Xs represent the MAC address and that the colons between the MAC addresses will not be shown.

NOTE: The factory setting for Bluetooth (BLE) is On (BLE = On). If Bluetooth (BLE) has been disabled (BLE = Off), the Bluetooth (BLE) advertisement will not be displayed.
8. The display will change back to showing live weight.
9. Press the  key to return to normal operation.

¹ If the Wi-Fi is Disconnected (disconnect), and a scan of the Wi-Fi networks shows “REDBIRD_WIFI_XX:XX” AP, then the Wi-Fi module is in listening mode. Refer to the **Configure Wi-Fi Network Module** section for the procedure to set the Wi-Fi credentials.

ERROR AND OPERATION MESSAGES

The DETECTO APEX-RI Portable Scale with Remote Indicator is equipped with diagnostic software that tests various portions of the scale's circuitry and verifies proper operation. Should a problem be detected, an error or status message will be displayed. The following is a list of these messages and their meanings.

Display Message	Meaning
→0←	This symbol indicates the scale weight reading is at the center of zero.
	This symbol appears if the weight has been manually locked by pressing the  key.
- - - -	This message appears if the  key has been pressed without any weight on the scale.
O C A P	The weight on the scale weight exceeds scale capacity.
E r r O F	This message appears if there are too many characters to display. For example, attempting to display a negative number greater than -9,999 or a positive number greater than 99,999.
L o b A t t	When the batteries are near the point where they need to be replaced, the scale display will show <i>L o</i> on the small upper seven-segment display and <i>b A t t</i> on the large lower seven-segment display. Note that when the battery voltage drops too low for accurate weighing, the scale will automatically shut off and you will be unable to turn it back on.
C A L I b	The scale requires calibration. The weight will show as dashes. Consult your scale service representative.
A d E r r E r r A L E r r A H	} Consult your scale service representative.

BEFORE YOU CALL FOR SERVICE

Problem	Possible Solutions
The display does not turn on.	<p>AC Operation:</p> <ul style="list-style-type: none"> • Is the AC power adapter fully inserted into the wall receptacle? • Check the wall receptacle for proper AC power. Try another electrical appliance in the same receptacle. Does it work? • Check the circuit breaker. • Has there been a power failure? <p>Battery operation:</p> <ul style="list-style-type: none"> • Check if the batteries are installed correctly. • If Alkaline, remove the old batteries and replace them with new ones. • If NI-CAD or NiMH, remove the discharged batteries and replace them with fully charged ones. Place the discharged batteries in an external charger to recharge.
Incorrect weight is displayed.	<p>Make sure the scale platform is not touching an adjacent object.</p> <p>Have proper operation procedures been followed?</p>
Weight is not displayed.	Refer to Error and Operation Messages.

CARE AND CLEANING



NOTE: The DETECTO APEX-RI Portable Scale with Remote Indicator contains no user-serviceable parts and maintenance should be limited to an occasional cleaning and battery replacement as required.

- Do not submerge the scale in water, pour, or spray water directly on it to clean it. The scale is not waterproof and covering it with water will damage it and void the warranty.
- Always remove power before cleaning.
- Do not use wire brushes, abrasives, or cleaning tools such as steel pads and scrapers, which will scratch the painted surface. Instead, use soft cloths or plastic scouring pads for cleaning.
- When possible, use treated water. Hard water can leave behind deposits. Soft water is much gentler on the painted steel's surface.
- Avoid the use of acetone, thinner or other volatile solvents, and abrasive-type cleaners for cleaning. If required, a mild solvent such as mineral spirits can be used to remove oil, grease, tars, wax, and similar substances. Use a cloth dampened with mineral spirits and apply only to areas that are contaminated. Follow up the use of this mild solvent with detergent cleaning and rinsing.

PARTS IDENTIFICATION

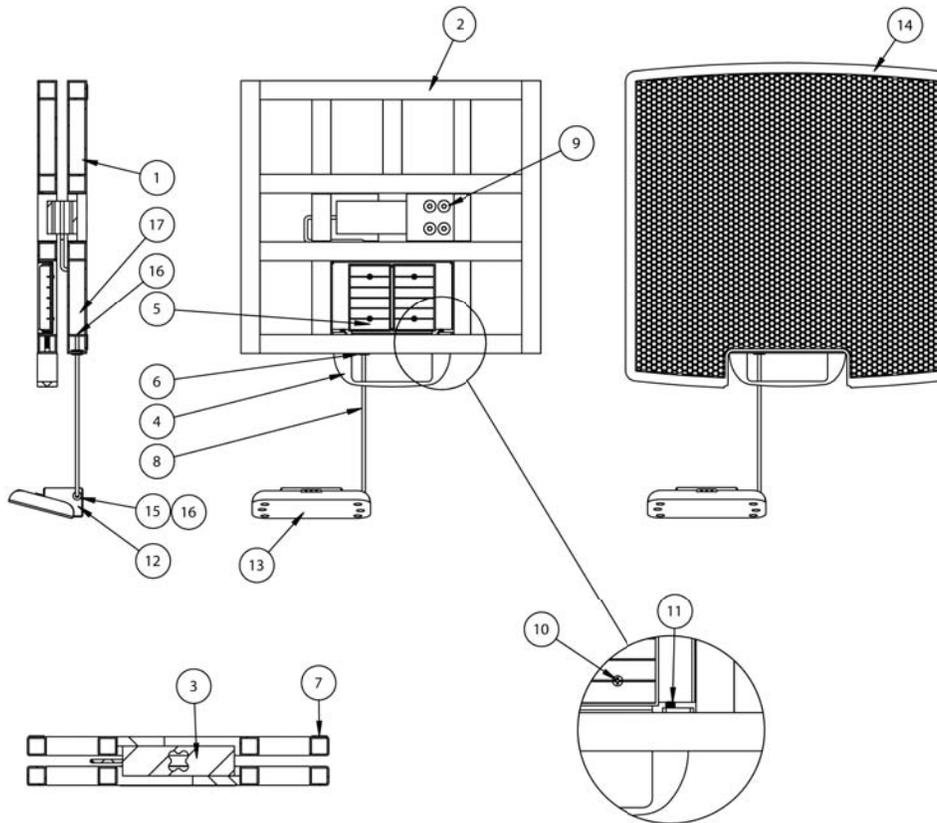

Item	Qty.	Part Number	Description
1	1	3300-0325-0A	BASE WELDMENT WITHOUT COLUMN BRACKET
2	1	3300-0326-0A	WEIGHBRIDGE WELDMENT
3	1	3300-0138-1A	APEX LOAD CELL
4	1	3300-0325-08	APEX PULL HANDLE
5	2	6610-1232	6X "AA" BATTERY HOLDER
6	1	6680-1043	GROMMET 1/4 ID X 5/8 OD FOR 1/8 TK
7	4	6540-1122	0.81 DIA RUBBER FOOT
8	1	3300-0330-0A	72" APEX-RI CABLE
9	8	6021-1550	FLAT-HEAD CAP SCW M8 X 1.25 X 30MM
10	4	6021-0654	PAN-HEAD SCW 06-32 X 0.25
11	2	6021-1554	SOCKET-HD CAP SCW 0.25-20 X 1.5
12	1	3300-0268-18	APEX INDICATOR BRACKET
13	1	3300-0356-0A 3300-0360-0A	APEX-RI-AC, DISPLAY SUB-ASSEMBLY APEX-RI-C-AC, DISPLAY SUB-ASSEMBLY
14	1	3300-0147-0A	APEX PLATFORM COVER
15	1	6680-0068	GROMMET RUBBER 3/16 ID X 7/16 OD
16	2	6980-0014	4" WHITE CABLE TIE
17	0.01	6710-1021	TAPE 1.88" X 60YDS DUCT ROLL
*	1	6800-1045	DOMESTIC: 100 TO 240 VAC 12 VDC 1A WALL MOUNT UL/CE APPROVED ADAPTER, US (TYPE B) INPUT PLUG
*	1	6800-1047	INTERNATIONAL: 100 TO 240 VAC 12 VDC 1A WALL MOUNT MULTI-BLADE UL/CE APPROVED ADAPTER, EU (TYPE C) AND UK (TYPE G) INPUT PLUGS

* NOT SHOWN

ACCESSORIES

Item Number	Description
APEX-RI-CASE	Carrying Case for APEX-RI and APEX-AT with Shoulder Strap (Form fitted to scale with cut-out for AC Adapter option)



STATEMENT OF LIMITED WARRANTY

DETECTO warrants its equipment to be free from defects in material and workmanship as follows: DETECTO warrants to the original purchaser only that it will repair or replace any part of equipment which is defective in material or workmanship for a period of **two (2) years from date of shipment**. Detecto shall be the sole judge of what constitutes a defect.

During the **first ninety (90) days** DETECTO may choose to replace the product at no charge to the buyer upon inspection of the returned item.

After the first ninety (90) days, upon inspection of the returned item, DETECTO will repair or replace it with a remanufactured product. The customer is responsible for paying for the freight both ways.

This warranty does not apply to peripheral equipment not manufactured by DETECTO; this equipment will be covered by certain manufacturer's warranty only.

This warranty does not include replacement of expendable or consumable parts. This does not apply to any item which has deteriorated or damaged due to wear, accident, misuse, abuse, improper line voltage, overloading, theft, lightning, fire, water or acts of God, or due to extended storage or exposure while in purchaser's possession. This warranty does not apply to maintenance service. Purchased parts will have a ninety (90) day repair or replacement warranty only.

DETECTO may require the product to be returned to the factory; item(s) must be properly packed and shipping charges prepaid. A return authorization number must be obtained for all returns and marked on the outside of all returned packages. DETECTO accepts no responsibility for items lost or damaged in transit.

Conditions Which Void Limited Warranty

This warranty shall not apply to equipment which:

- A.) Has been tampered with, defaced, mishandled or has had repairs and modifications not authorized by DETECTO.
- B.) Has had serial number altered, defaced, or removed.
- C.) Has not been properly grounded according to Detecto's recommended procedure.

Freight Carrier Damage

Claims for equipment damaged in transit must be referred to the freight carrier in accordance with freight carrier regulations.

This warranty sets forth the extent of our liability for breach of any warranty or deficiency in connection with the sale or use of the product. DETECTO will not be liable for consequential damages of any nature, including but not limited to, loss of profit, delays or expenses, whether based on tort or contract. Detecto reserves the right to incorporate improvements in material and design without notice and is not obligated to incorporate improvements in equipment previously manufactured.

The foregoing is in lieu of all other warranties, express or implied including any warranty that extends beyond the description of the product including any warranty of merchantability or fitness for a particular purpose. This warranty covers only those DETECTO products installed in the forty-eight (48) contiguous continental United States.



Ph. (800) 641-2008
E-mail: detecto@cardet.com
102 E. Daugherty
Webb City, MO 64870

04/22/2024
Printed in USA
D268-WARRANTY-DET-B



DETECTO
102 E. Daugherty, Webb City, MO 64870 USA
Ph: 417-673-4631 or 1-800-641-2008
Fax: 417-673-2153
www.Detecto.com
Technical Support: 1-866-254-8261
E-mail: tech@cardet.com