



CARDINAL®



212/212X WEIGHT INDICATOR Installation and Technical Manual

Introduction

Thank you for selecting and purchasing the Cardinal Model 212/212X Weight Indicator. The Model 212/212X indicator was built with quality and reliability and incorporates the latest in digital technology and innovative features for the weighing industry. Configuration and upgrades can easily be performed in the field, while still maintaining the rigid control the most demanding installations require. This flexibility insures the Model 212/212X will be able to meet your weight indicating needs for years to come.

The purpose of this manual is to provide you with a guide through installation, setup and operation of your new Model 212/212X Weight Indicator. Please read it thoroughly before attempting to install your indicator and keep it handy for future reference

Copyright



All rights reserved. Reproduction or use, without expressed written permission, of editorial or pictorial content, in any manner, is prohibited. No patent liability is assumed with respect to the use of the information contained herein.

Disclaimer

While every precaution has been taken in the preparation of this manual, the Seller assumes no responsibility for errors or omissions. Neither is any liability assumed for damages resulting from use of the information contained herein. All instructions and diagrams have been checked for accuracy and ease of application; however, success and safety in working with tools depend to a great extent upon the individual accuracy, skill and caution. For this reason the Seller is not able to guarantee the result of any procedure contained herein. Nor can they assume responsibility for any damage to property or injury to persons occasioned from the procedures. Persons engaging the procedures do so entirely at their own risk.

PRECAUTIONS

Before using this indicator, read this manual and pay special attention to all "WARNING" symbols:

	IMPORTANT		ELECTRICAL WARNING		STATIC SENSITIVE
---	------------------	---	-------------------------------	--	-----------------------------

FCC Compliance Statement

This equipment generates uses and can radiate radio frequency and if not installed and used in accordance with the instruction manual, may cause interference to radio communications. It has been tested and found to comply with the limits for a Class A computing device pursuant to Subpart J of Part 15 of FCC rules, which are designed to provide reasonable protection against such interference when operated in a commercial environment. Operation of this equipment in a residential area may cause interference in which case the user will be responsible to take whatever measures necessary to correct the interference.

You may find the booklet “How to Identify and Resolve Radio TV Interference Problems” prepared by the Federal Communications Commission helpful. It is available from the U.S. Government Printing Office, Washington, D.C. 20402. Stock No. 001-000-00315-4.

Proper Disposal

When this device reaches the end of its useful life, it must be properly disposed of. It must not be disposed of as unsorted municipal waste. Within the European Union, this device should be returned to the distributor from where it was purchased for proper disposal. This is in accordance with EU Directive 2002/96/EC. Within North America, the device should be disposed of in accordance with the local laws regarding the disposal of waste electrical and electronic equipment.

It is everyone's responsibility to help maintain the environment and to reduce the effects of hazardous substances contained in electrical and electronic equipment on human health. Please do your part by making certain that this device is properly disposed of. The symbol shown to the right indicates that this device must not be disposed of in unsorted municipal waste programs.



TABLE OF CONTENTS

1. OVERVIEW	1
1.1 Specifications	1
Model Number Description	2
Standard Features	3
Options	4
Accessories	5
1.2. Precautions	7
Static Electricity.....	7
1.3 Key Descriptions	9
1.4 Annunciators	17
2. GETTING STARTED.....	21
2.1 Installation	21
Site Preparation Requirements.....	21
Environmental.....	21
Electrical Power.....	21
Transient Suppression.....	21
Mounting the 212/212X.....	23
Installing the Wall Bracket	24
Cable Connections.....	25
DC Power Cable Connection.....	27
Scale Cable Connections	29
Serial and I/O Cable Connection	31
AGSIO (Serial/DIO Mating Connector Cable).....	32
Optically Isolated Inputs.....	33
Optically Isolated Outputs.....	33
Optional DC Output Relay Board	35
Main PCB (Printed Circuit Board)	37
Main PCB Jumpers.....	38

2.2. Indicator Setup	39
Setup Data Entry.....	39
Quick Calibration.....	41
Quick Calibration Weigh Bar Table.....	43
Full Setup and Configuration	45
Settings.....	47
Analog to Digital Filtering	59
Filter Setting Recommendations	63
Calibration.....	65
Weigh Bar Table (Calibration Mode Selection 1).....	67
Enter Load Cell Specs (Calibration Mode Selection 2).....	69
Other Calibration Modes (Calibration Mode Selection 3).....	71
Dual-Point with Zero (First Zero) Calibration	71
Dual-Point without Zero (False Zero) Calibration.....	73
Single-Point for Span Only (Last Zero) Calibration.....	75
Single-Point for Zero Only (Only Zero) Calibration	77
Calibration “[” Numbers	79
Serial Input/Output.....	81
Print Tab Settings	85
Fine Span Adjustment.....	89
Display High Resolution Weight.....	91
Key Lock Out Function.....	91
Storing Indicator Defaults.....	93
Restoring Indicator Defaults.....	93
2.3 INDICATOR SETUP REVIEW.....	95
Accessing Setup Review	95
2.4 INDICATOR OPERATIONAL SETUP REVIEW	97
Accessing and Navigating the Operational Setup Review	97

3. OPERATION	99
3.1 Standard Weighing.....	99
3.2 Subtractive Weighing	100
3.3 Auto-Hold for Animal Weighing	101
3.4 Preset Weight Comparator (PWC)	103
3.5 Digital Fill Control (DFC)	105
Specified Target Weight DFC	105
Simple DFC (Simple-Fill)	110
Box-Tracker DFC Mode (Box Fill)	114
Plot-Tracker DFC Mode (Plot Fill)	117
3.6 Using Memory/ID Storage	125
4. SERVICE	131
4.1 Troubleshooting.....	131
Error and Status Messages	133
4.2 Care and Maintenance	137
4.3 Parts.....	138
Rear Sub-Assembly	138
Front Sub-Assembly	140
Final Assembly.....	142

1. OVERVIEW

1.1 Specifications

Power Requirements:	12VDC (10.5-14.4VDC) using an external battery or an optional 12VDC @ 1A, AC Power Adapter (Cardinal part number AGPS)
Enclosure Type:	Thermoplastic
Enclosure Size:	9.0" H x 11.2" W x 4.3" D (229mm H x 284mm W x 109mm D)
Shipping Weight:	12 lbs / 5.4 kg
Operating Environment:	-4 to 158 °F (-20 to +70 °C)
Display: 212 (212-1S, 212-4S) 212X (212X-1S, 212X-4S)	12 digit, 15 segment, 0.8" high backlit, transfective LCD, 12 annunciators 6 digit, 15 segment, 2" high backlit, transfective LCD, 18 annunciators
Transducer Excitation:	9.4 VDC
Signal Input Range:	1.0 mV min. to 31 mV max. (with dead load boost)
Number of Load Cells:	8 each, 350 OHM minimum resistance
Division Value:	0 to 99
Sensitivity:	0.15uV/e
Scale Divisions:	100 to 240,000
Internal Resolution:	1 part in 16,777,216
Tare Capacity:	Scale Capacity
Sample Rate:	1 to 100 samples per second, selectable
Auto Zero Range:	0.5 or 1 through 9 divisions
Weighing Units:	Pounds/Kilograms
Keypad:	Color coded Membrane type, 24 keys
Standard I/O:	(1) bi-directional RS232 (1) output only 20mA

Model Number Description

212

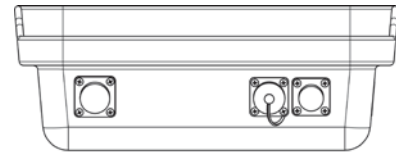
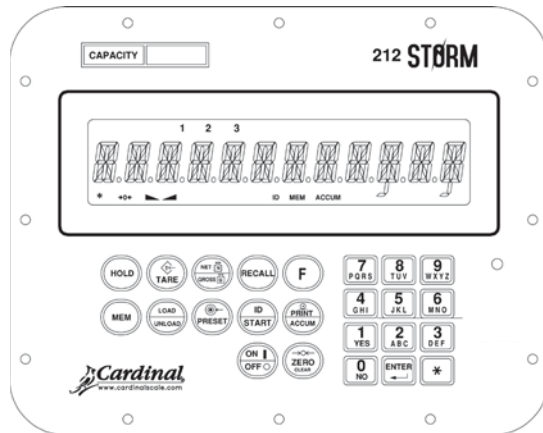

212-1S – Bottom View

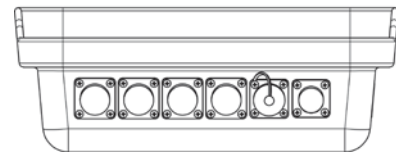

212-4S – Bottom View

Figure No 1

212X

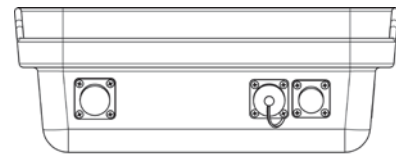
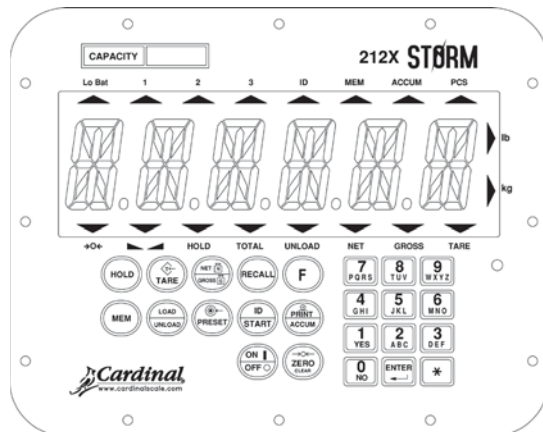

212X-1S – Bottom View

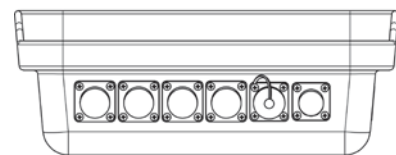

212X-4S – Bottom View

Figure No. 2

Standard Features

- Push Button Tare Function
- Keypad Tare Function
- Gross, Tare, Net Conversion
- Selectable Key Lockout
- Hi-Resolution Mode
- StableSENSE[®]¹ adjustable digital filtering
- Gross and Net Accumulators
- Dual Serial Ports
- Remote Inputs
- SMA level 2 Compliant Serial Communications (For more information see <http://www.scalemanufacturers.org>)
- Field re-programmable via PC interconnection
- Test Feature (Performs Display and Internal Tests)
- Auto Shutoff and Sleep modes
- Alphanumeric Keypad
- Time and Date with Selectable 12 or 24 hour Operation
- Three Preset Weight Comparators
- Load/Unload
- Hold Weight
- 100 ID Alpha-numeric Storage
- Digital Fill Control
 - Single or Two Speed Operation
 - Chatter Gate
 - Multiple Cycles
- Auto-Print on Balance

¹ StableSENSE[®] is a digital filter utilizing proprietary software algorithms to remove or greatly reduce changes in the weight display resulting from movement on the scale platform. StableSENSE[®] can be used with livestock and single animal scales to lessen the effects of the animal's movement on the scale or it can be used with vehicle scales to lessen the effects of wind and vehicle vibration. Any application affected by vibration or movement on the scale platform can benefit using StableSENSE[®].

Options

- Analog Output
- 100/100 mbps Ethernet Adapter
- RS-232 Port – Bi-Directional Serial Port. Multiple printouts available for transfer of data to printer or computer.
- Wireless Motor Control.
- Wireless Remote Control (using the 2XX-KEYFOB) for Print, Zero and Gross/Net Switching.
- Remote Display Port – Allows interface to RD2 (2 1/4" LED or RD3 (2" LCD)
- Printers – Tape and Ticket printers available.
- Remote Displays – Large Scoreboard Displays (SB250 or SB500) for permanent installations.
- Internal Relay Box
- External Relay Box

Accessories

POWER

AGPWRMATE ·····	Power Mating Connector
AGPS ·····	12VDC @ 1A, AC Power Adapter with Power Mating Connector
AGDC6 ·····	Power Mating Connector with 6ft Cable and Battery Terminal on end
AGDC12 ·····	Power Mating Connector with 12ft Cable and Battery Terminal on end
AGDC18 ·····	Power Mating Connector with 18ft Cable and Battery Terminal on end

LOAD CELL

AGLCMATE ·····	Load Cell Mating Connector
AGLC12 ·····	12ft Load Cell cable with connector (from indicator to J-box)
AGLC17 ·····	17ft Load Cell cable with connector (from indicator to J-box)
AGLC25 ·····	25ft Load Cell cable with connector (from indicator to J-box)
AGJBOX4 ·····	J-Box with 2 gland connectors and 4 load cell connectors with terminal strip inside
AGJBOX4GL ·····	J-Box with 6 gland connectors with terminal strip inside

INPUT/OUTPUT

AGSIO ·····	Serial/DIO Mating Connector with 12ft Cable
AGSIOBOX ·····	Serial/DIO Mating Connector with 12ft Cable and J-Box with terminal strip inside

MOUNTING

212VMOUNTKIT ···	V Mount parts (Both V Brackets, Shock Mounts and Screws) to attach 212's to Wall or Frame
212VMOUNT ·····	Additional Wall or Frame Mount Only
212DESKMOUNT ···	Desk Mount

1.2. Precautions

Static Electricity



CAUTION! This device contains static sensitive circuit cards and components. Improper handling of these devices or printed circuit cards can result in damage to or destruction of the component or card. Such actual and/or consequential damage **IS NOT** covered under warranty and is the responsibility of the device owner. Electronic components must be handled only by qualified electronic technicians who follow the guidelines listed below.



ATTENTION! ALWAYS use a properly grounded wrist strap when handling, removing or installing electronic circuit cards or components. Make certain that the wrist strap ground lead is securely attached to an adequate ground. If you are uncertain of the quality of the ground, you should consult a licensed electrician.



ALWAYS handle printed circuit card assemblies by the outermost edges.

NEVER touch the components, component leads or connectors.

ALWAYS observe warning labels on static protective bags and packaging and never remove the card or component from the packaging until ready for use.

ALWAYS store and transport electronic printed circuit cards and components in anti-static protective bags or packaging.

1.3 Key Descriptions

The Model 212/212X is equipped with a 24-key keypad. The keypad is used to enter commands and data into the instrument. This section describes each key along with its normal function. It is helpful to refer to the actual instrument while reading this section.



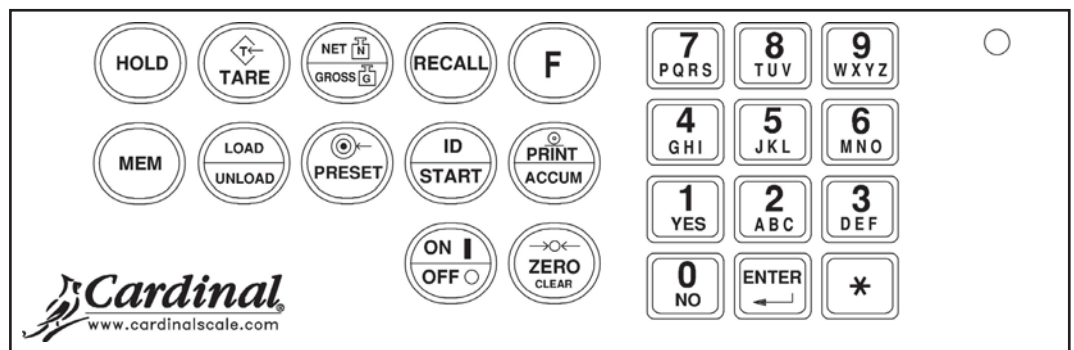

DO NOT operate the keypad with pointed objects (pencils, pens, etc). **Damage to keypad resulting from this practice is**





NOT covered under warranty



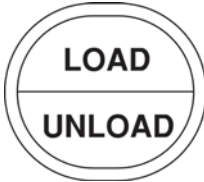

Figure No. 3



Key	Description
	<p>The ON/OFF key is used to turn the indicator on and off.</p> <ul style="list-style-type: none"> • Press the ON/OFF key when the indicator is off to turn the indicator ON. The 212/212X will show the model number and software version and then change to the weight display. • If the indicator is already on, press the ON/OFF key. The display will show <i>OFF</i> and turn the indicator OFF.



Key	Description
	<p>The ZERO/CLEAR key is used to zero the weight display. Up to the selected limit of 4% or 100% of the scale's capacity can be zeroed. This limit is selected during the setup and calibration of the indicator.</p> <p>Note that the indicator will not respond to pressing the ZERO/CLEAR key unless the weight display is stable.</p> <ul style="list-style-type: none"> • When displaying a Tare weight, pressing the ZERO/CLEAR key will clear the Tare value and set the display to Gross mode. • When an ID has been selected, the user can erase that id by pressing the F key and then ZERO/CLEAR key. The user will be prompted to confirm and will need to press YES or NO. • Pressing the ZERO/CLEAR key while scrolling through the IDs using the RECALL key will also prompt the user to confirm ID erase. • Pressing the ZERO/CLEAR key while the current IDs accumulator is being display will prompt the user to clear this accumulator. The user will be prompted to confirm and will need to press YES or NO.



Key	Description
	<p>Pressing the MEM key followed by the PRINT/ACCUM key will print all of the IDs along with their stored information</p> <p>Pressing this key will prompt the user to enter an ID to store. If <i>DDUT</i> = 4 or 14, they will then be prompted to store preset values for that ID</p>
	<p>Pressing this key while weight is displayed on the screen will cause that value to be stored as the Tare weight (LOAD), switch to Net weight display mode and turn on the UNLOAD annunciator.</p> <p>Now, when the weight is removed from the scale, the indicator will show the weight removed as a positive number.</p> <p>Pressing this key again will return to Gross weight display mode and turn off the UNLOAD annunciator.</p>

Key	Description
 <p>PRESET</p>	<p>The PRESET key allows the operator to change different presets for different <i>D-OUT</i> settings.</p> <p><i>THRES</i>= This is the threshold weight used with the Auto Hold feature (this prompt only appears when <i>D-OUT</i> = is 1, 2, 3, 11, 12 or 13 and <i>A-HLD</i>= 1 or 2).</p> <p><i>PSET1</i>-, <i>PSET2</i>-, and <i>PSET3</i>-, are for <i>D-OUT</i> = 1, 2, or 3 and 11, 12 or 13 respectively.</p> <p><i>D-OUT</i>= 4 or 14 is for Digital Fill Control. If this is selected, pressing the PRESET key will display the following prompts:</p> <p>(if <i>SPEED</i>= 1) <i>FILL</i>= Weight at which PWC1 will shut off (fill weight)</p> <p>(if <i>SPEED</i>= 2) <i>FAST</i>= Fast filling weight <i>SLOW</i>= Slow filling weight <i>CHATR</i>= Incremental weight for chatter gate open and close (if <i>GATE</i>= 3)</p> <p><i>TRIM</i>= Anticipated weight of material still falling onto scale in order to obtain more accurate fill weight.</p>

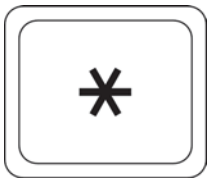
Key	Description
	<p>This is a dual function key. Pressing it alone will prompt for an ID to be entered.</p> <p>When using the Digital Fill Control feature, pressing the F key and then this key (START) will start the fill operation.</p>
	<p>Pressing this key will add the current weight to the accumulator in use and display the accumulated weight.</p> <p>Pressing this key a second time will print and return to the weight display mode.</p> <p>Pressing the F key before this key will perform a print only.</p> <p>NOTE: This key will be disabled while the hold annunciator is on.</p>
	<p>The HOLD key is used to lock and unlock the weight display. Pressing this key (after obtaining a stable weight) will cause the indicator to lock onto the weight. To indicate that the weight display is locked, the 212 will show <i>HOLD</i> on the right of the display. The 212X will turn on the HOLD annunciator.</p> <p>Pressing this key again will unlock the weight display and return it to the weight display mode.</p>
	<p>The TARE key is a dual function key. Pressing the TARE key alone will store the current gross weight as a new tare weight and cause the weight display to change to the net weight display mode. This is known as Pushbutton Tare mode.</p> <p>Pressing the key after entering a numeric value (Keypad Tare) will cause the value entered to be accepted as a new tare weight.</p> <p>NOTE: Tare weights equal to or greater than scale capacity cannot be entered. In addition, keypad tare weight division value must be same as scale division value. For example, a unit with 5 lb as division value will display <i>ERROR</i> if you enter 3 for tare weight.</p>

Key	Description
	<p>The NET/GROSS key is used to toggle between the Gross and Net weight modes. The selected mode is indicated by turning on the appropriate annunciator on the display.</p> <p>Note that if no valid tare weight has been entered, pressing the NET/GROSS key will cause a momentary display error (<i>NOTARE</i>) and the indicator will remain in the Gross weight mode.</p>
	<p>Pressing the RECALL key will cycle through the stored IDs in numerical/alphabetical order one (1) at a time.</p> <p>NOTE: While cycling through IDs, all other keys except ENTER, *, RECALL and MEM will be disabled.</p> <p>Pressing this key while memory is empty will display "<i>NO IDS</i>"</p> <p>If an ID has already been previously selected, the indicator will start cycling through the list at selected location.</p> <p>Pressing the PRINT key while displaying an ID using the RECALL key will print that ID file information.</p>

Key	Description
	<p>Pressing the F key will display “ F--”. All other keys will be disabled except:</p> <p>0/NO. This key sequence is used to enter the Setup and Configuration mode. While in Setup and Configuration, pressing the F key will step to the beginning of each setup section.</p> <p>RECALL: This key sequence initiates the accumulator statistics (<i>R-STAT</i>) menu.</p> <p>CLEAR: Exits this display and returns to displaying weight if an ID is not selected. If an ID is selected, the user will be prompted to confirm an ID erase.</p> <p>3: This key sequence is used to set the Date and Time.</p> <p>8: This key sequence is used to change units.</p> <p>*: Exits this display and returns to displaying weight.</p> <p>START: Used for starting a Digital Fill Control cycle.</p> <p>PRINT: If an ID is selected, the stored ID information will be printed. If an ID is not selected, the indicator will perform a print using the print tab settings.</p>
	<p>Pressing the * (asterisk) key after an ID has been selected will exit “ID Mode.” The ID and MEM annunciators will blink twice to signify this.</p> <p>If an ID has not been selected the indicator will display “<i>FUNCT=</i>”.</p> <p>Pressing the F key after the * key will enter the Setup Review mode where some of the indicator Setup and Configuration parameters can be changed.</p>
	<p>The ENTER key serves two purposes. First, when reviewing setup parameters, pressing the ENTER key will display the current setting of the parameter.</p> <p>Second, the ENTER key is used to signal completion of the entry of data and causes the indicator to process the data entered.</p>

Key	Description
	<p>These keys are used to enter alphanumeric data during the setup and calibration as well as during normal operation of the indicator.</p> <p>To enter letters, you must press the key in succession until the desired letter is displayed. This is similar to the way a cell phone keypad operates. (Ex: If you want to enter the letter C, you would need to press the 2 key four times).</p>
	<p>The 1/YES key is a dual function key.</p> <p>During setup and configuration as well as normal operations, it is used to enter numeric data.</p> <p>In addition, it is used to answer YES (1 = YES) to various prompts during setup and configuration as well as during normal operations.</p>
	<p>The 0/NO key has several functions.</p> <p>During setup and configuration as well as normal operations, it is used to enter numeric data.</p> <p>In addition, it is used to answer NO (0 = NO) to various prompts during setup and configuration as well as during normal operations.</p> <p>Pressing the 0/NO key after the F key will enter the Setup and Configuration mode where the indicator Setup and Configuration parameters can be changed as well as calibration performed.</p>

1.4 Annunciators

The Model 212/212X is equipped with annunciators that are turned on to indicate that the display is in the mode corresponding to the annunciator label or that the status indicated by the label is active. This section describes each annunciator. Refer to Figure No. 4 and 5 for the location of the annunciators.

Figure No. 4

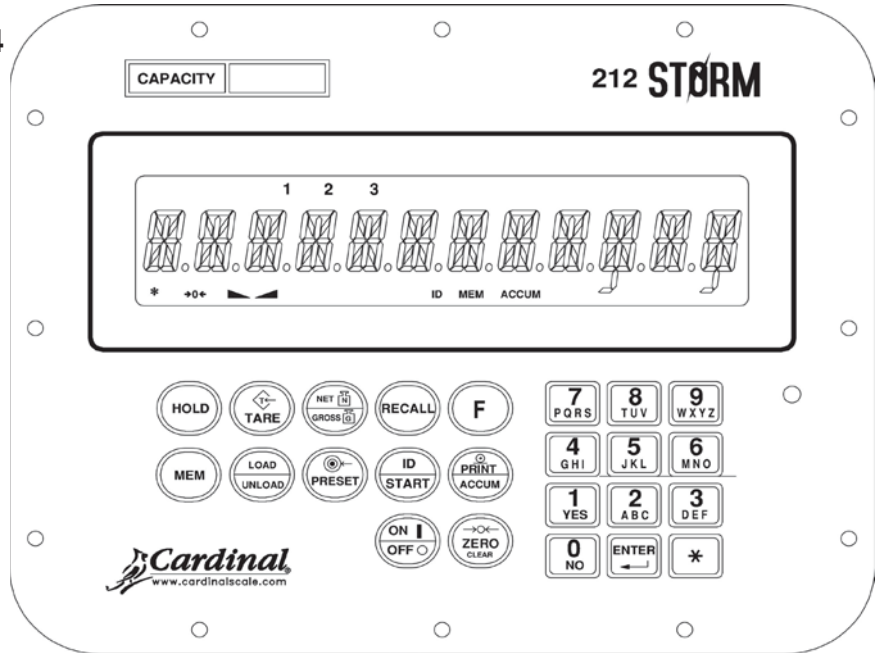
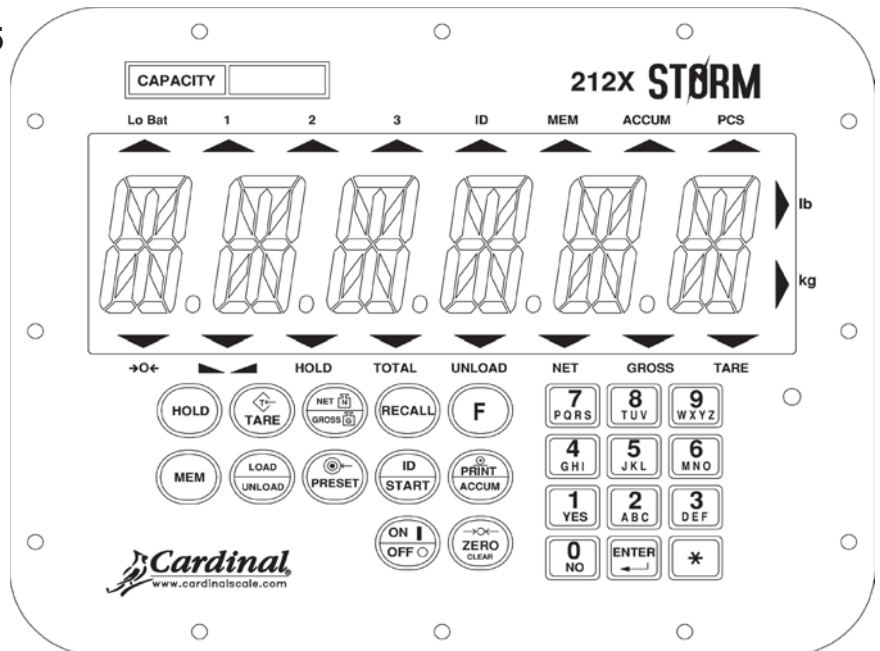



Figure No. 5



Name	Description
→0←	This is the ZERO annunciator. It is turned on to indicate that the weight displayed is within $\pm 1/4$ division of true zero.
	This is the STABLE weight annunciator. It is turned on when the weight display is stable. When off, it means that the change in successive weight samples is greater than the motion limits selected during setup.
<i>HOLD</i> HOLD	To indicate the current displayed weight is held (using either the HOLD key or the Auto-Hold feature), the 212 will show <i>HOLD</i> on the right of the display. The 212X will turn on the HOLD annunciator.
<i>TOL</i> TOTAL	To indicate the current displayed value is a summation, the 212 will show <i>TOL</i> on the right of the display. The 212X will turn on the TOTAL annunciator.
<i>UNLOAD</i> UNLOAD	To indicate the scale is in UNLOAD mode, the 212 will show <i>UNLOAD</i> on the right of the display. The 212X will turn on the UNLOAD annunciator.
<i>N</i> NET	To indicate the current displayed weight is Net weight (Gross weight less Tare weight), the 212 will show <i>N</i> on the right of the display. The 212X will turn on the NET annunciator.
<i>G</i> GROSS	To indicate the current displayed weight is Gross weight, the 212 will show <i>G</i> on the right of the display. The 212X will turn on the GROSS annunciator. Note that Gross weight will be displayed when no tare weight is stored.

Name	Description
<p style="text-align: center;">\bar{T} TARE</p>	<p>To indicate the current displayed weight is the Tare weight, the 212 will show \bar{T} on the right of the display. The 212X will turn on the TARE annunciator.</p>
<p style="text-align: center;">lb lb</p>	<p>This annunciator is located to the right of the weight display and is turned on to show that the displayed weight unit is pounds.</p>
<p style="text-align: center;">kg kg</p>	<p>This annunciator is located to the right of the weight display and is used to indicate that the displayed unit of weight measurement is kilograms.</p>
<p style="text-align: center;">* Lo Bat</p>	<p>To indicate the battery does not have a sufficient charge, the 212 will turn on the * (asterisk) on the lower left side of the display. The 212X will turn on the LoBat annunciator.</p>
<p style="text-align: center;">Lo bat</p>	<p> IMPORTANT! When the battery voltage drops to a level where operation is affected, the indicator will display this message and automatically turn OFF.</p>
<p style="text-align: center;">1, 2, 3</p>	<p>These numeric annunciators are turned on to signal that the corresponding PWC output is active.</p>
<p style="text-align: center;">ID</p>	<p>The ID annunciator is turned on to indicate that the value displayed is the identification number currently in use.</p>

Name	Description
MEM	The MEM annunciator is used by the ID Storage feature and is turned on to show that the indicator is performing an ID storage function. It is used in conjunction with the ID annunciator to indicate when a permanent ID number is to be entered.
ACCUM	The ACCUM annunciator is turned on to indicate that the value displayed is the contents of the accumulator associated with the currently selected ID number.
<i>CNT</i> PCS	To indicate that the value displayed is a count quantity and not weight, the 212 will show <i>CNT</i> on the right of the display. The 212X will turn on the PCS annunciator.

2. GETTING STARTED

2.1 Installation

Site Preparation Requirements

The Cardinal Model 212/212X indicator is a precision weight-measuring instrument. As with any precision instrument, it requires an acceptable environment to operate at peak performance and reliability. This section is provided to assist you in obtaining such an environment.

Environmental

The 212/212X indicator meets or exceeds all operating requirements within a temperature range of -4 to 158 °F (-20 to +70 °C).

Electrical Power

The 212/212X indicator has been designed to operate from 12VDC (10.5-14.4VDC) using an external battery or an optional 12VDC @ 1A, AC Power Adapter (Cardinal part number AGPS)

Transient Suppression

The following recommendations will help to reduce transients:

- Always use shielded cables to connect signal wires to the weight indicator.
- Keep wires that extend beyond the shield as short as possible.
- Do not run load cell or signal cables from the weight indicator along side or parallel to wiring carrying AC power. If unavoidable, position the load cell and signal cables a minimum of 24" away from all AC wiring.
- Use zero voltage switching relays, optically isolated if possible.

RFI Immunity

The operation of sensitive electronic equipment can be adversely affected by RF (Radio Frequency) radio transmissions. Digital weight indicators are one such type of equipment. Radio transmissions come from things like hand-held radio transmitters and cell phones. One symptom of RFI (Radio Frequency Interference) in a digital weight indicator is weight indication instability during a radio transmission.

Cardinal digital weight indicators are designed with special grounding and RFI shielding to achieve a high degree of immunity to common RFI. To maximize the digital weight indicator's immunity to radio transmissions, follow these guidelines:

1. ALWAYS use shielded cable for all I/O (Input/Output) connections to the digital weight indicator.
2. NEVER operate any radio transmitter within 2 meters (~6ft.) of the weight indicator.
3. NEVER connect un-terminated serial, digital, or analog I/O cables to the internal printed circuit boards of the digital weight indicator.
4. KEEP the intended external I/O devices connected to I/O cables interrering the digital weight indicator.
5. ALWAYS connect the shield of the shielded cable to the indicator back panel gland connector or other closest ground terminal inside the indicator.
6. ALWAYS connect the shield of the shielded I/O cable at the indicator end only. Leave the shield unconnected at the I/O device.

Mounting the 212/212X

Before beginning installation of your Model 212/21X indicator, make certain that it has been received in good condition. Carefully remove it from the shipping carton and inspect it for any evidence of damage (such as exterior dents or scratches) that may have taken place during shipment. Keep the carton and packing material for return shipment if it should become necessary. It is the responsibility of the purchaser to file all claims for any damages or loss incurred during transit.

The Model 212/212X is housed in a Thermoplastic enclosure which mounts to a wall or smooth, flat, vertical surface using a quick-detach bracket.

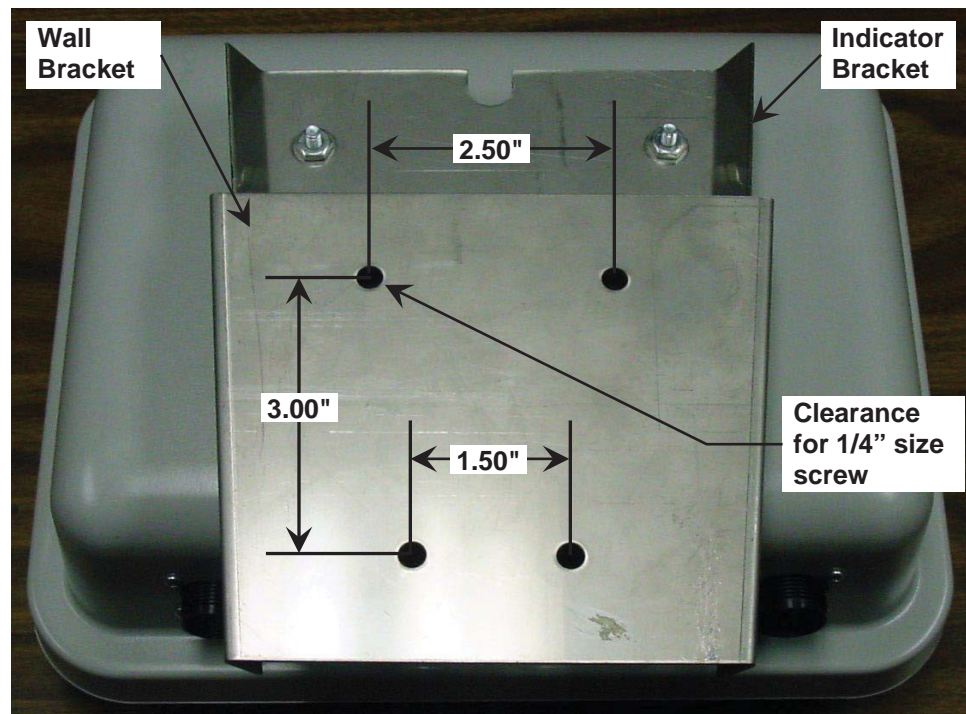

Figure No. 6

Installing the Wall Bracket

Refer to Figure No. 6 for a layout of the wall bracket mounting holes.

1. Make certain the mounting surface is strong enough to support the indicator and that the mounting location is where the display can easily be viewed while being close enough to provide the operator easy access to the keypad.
2. Position the wall bracket with the wider end at the top and mark the desired mounting location.
3. Using the wall bracket as a template, mark the mounting hole locations and drill the holes.
4. Install the screws through the wall bracket and securely tighten.
5. Insert the narrow end of the indicator bracket into the wide end of the mounted wall bracket and pull down into place.

Cable Connections

The Model 212/212X uses nylon circular DIN connectors (similar to the Amphenol® military type connectors) for all cable connections. Depending on the model, there are one or four Scale connectors, one Serial and I/O connector and one DC power connector.

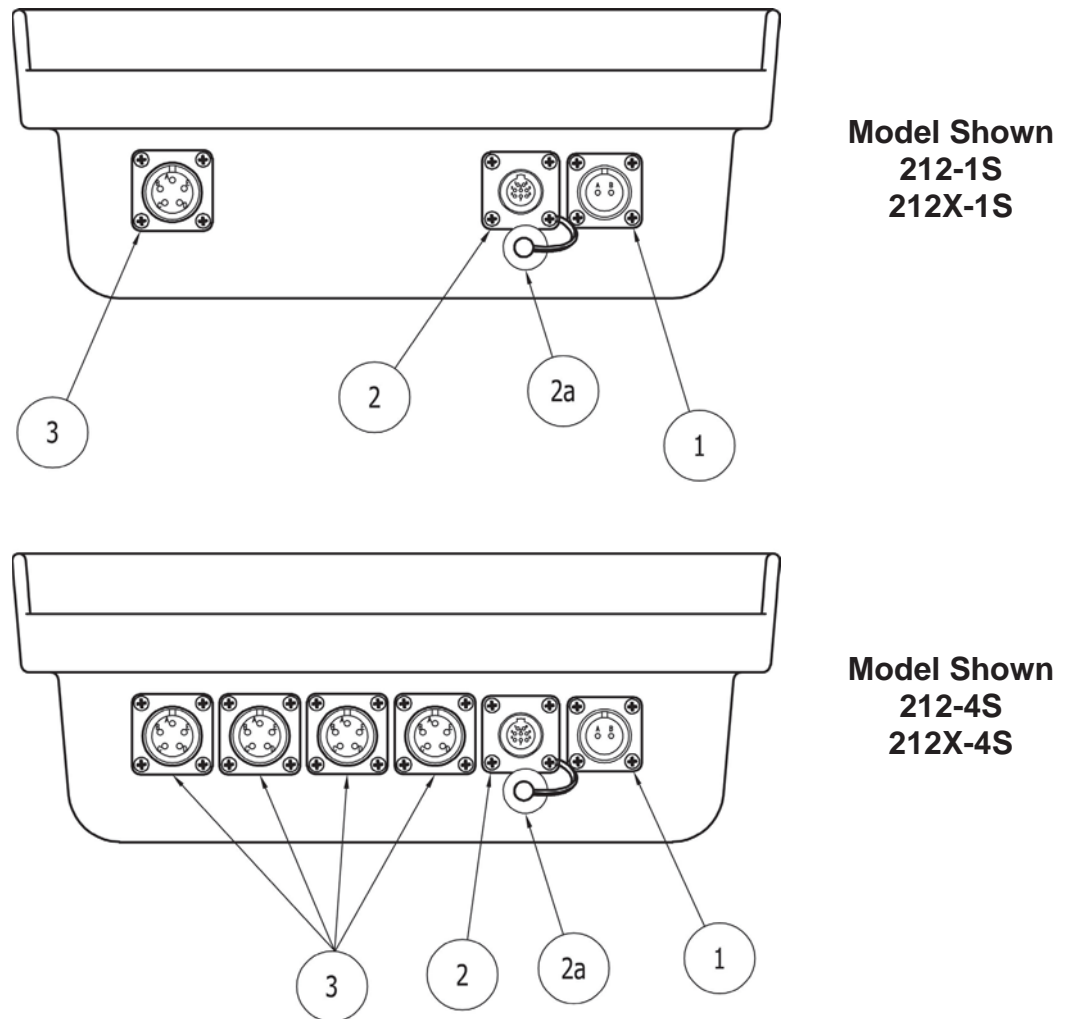

Figure No. 7

Item	Description
1	Power Connector – 12VDC (10.5 to 14.4VDC)
2	I/O Connector – Serial, Isolated Inputs/Outputs
2a	I/O Connector Dust Cover – CPN 6610-2126
3	Scale Connector – 1 or 4 Scales (depending on model, 1S or 4S)

DC Power Cable Connection

The 212/212X has been designed to operate from 12VDC using a 2-pin power input connector. The input power source is an external 12V battery and should be 10.5 to 14.4VDC. The positive (red) power wire is connected to the “A” pin on the connector and the GND (black) wire is connected to the “B” pin on the connector.

DC Power Connector Wiring

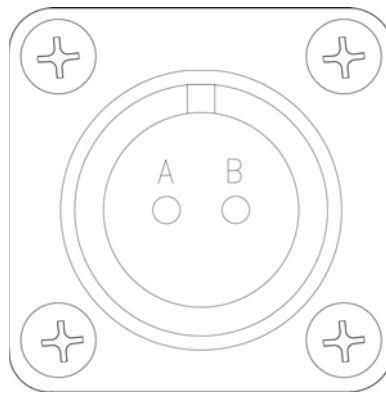

Pin No.	Description
A	+12VDC (Red Wire) (10.5 to 14.4VDC)
B	GND (Black Wire) (Ground)

Figure No. 8

Figure No. 8 above is the 2-pin DC Power connector as viewed from the bottom of the indicator.

Connect the wires from the power source cable to the 2-pin power connector. Note that the DC Power connector on the indicator identifies the connector pins.

Scale Cable Connections



CAUTION! Disconnect any external load cell power supply before connecting load cells to the indicator. Failure to do so will result in permanent damage to the indicator.

Scale Connector Wiring

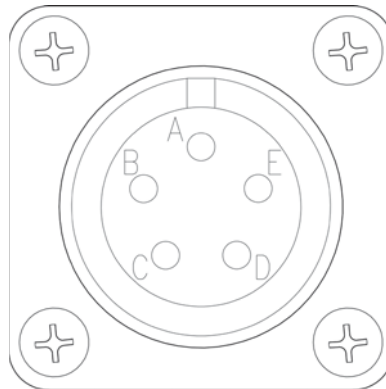

Pin No.	Description
A	- SIGNAL
B	+ EXCITATION
C	+ SIGNAL
D	- EXCITATION
E	GND = SHIELD (Connect the load cell cable shield wire here).

Figure No. 9

Figure No. 9 above is the 5-pin Scale connector as viewed from the bottom of the indicator.

Connect each of the scale cable wires to the 5-pin scale connector. Note that the scale connectors on the indicator identify the connector pins.

Serial and I/O Cable Connection

The 212/212X I/O cable connection (*user specified*) may be connected to the internal serial RS-232 or 20mA current loop terminals to be connected to a printer to record weight and associated data or to a remote display or even to a computer for transmission of weight data.

When connected to the appropriate serial communication terminals, the weight data may be transmitted on demand (pressing the **PRINT** key or on receipt of a command from a computer).

Serial and I/O Connector

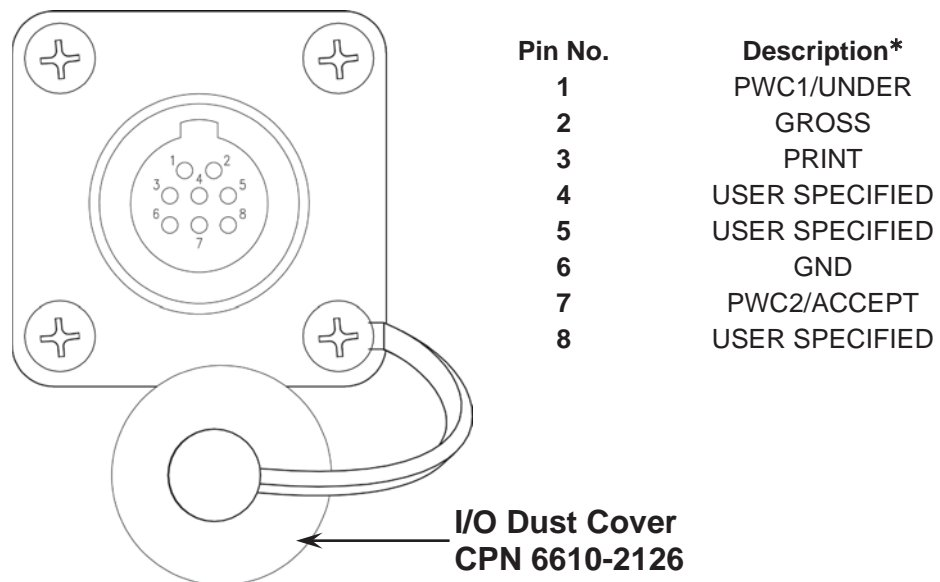

Figure No.10

Figure No. 10 above is the Serial and I/O connector as viewed from the bottom of the indicator.



IMPORTANT! Figure No. 10 is for reference only. Connections to the Serial and I/O connector require Cardinal Part Number "AGSIO", Serial/DIO Mating Connector with 12 ft cable. See Figure No. 11

* The pin number descriptions are typical connections. The connector can be configured with various Input/Output functions depending on the requirements of the operation.

AGSIO (Serial/DIO Mating Connector Cable)

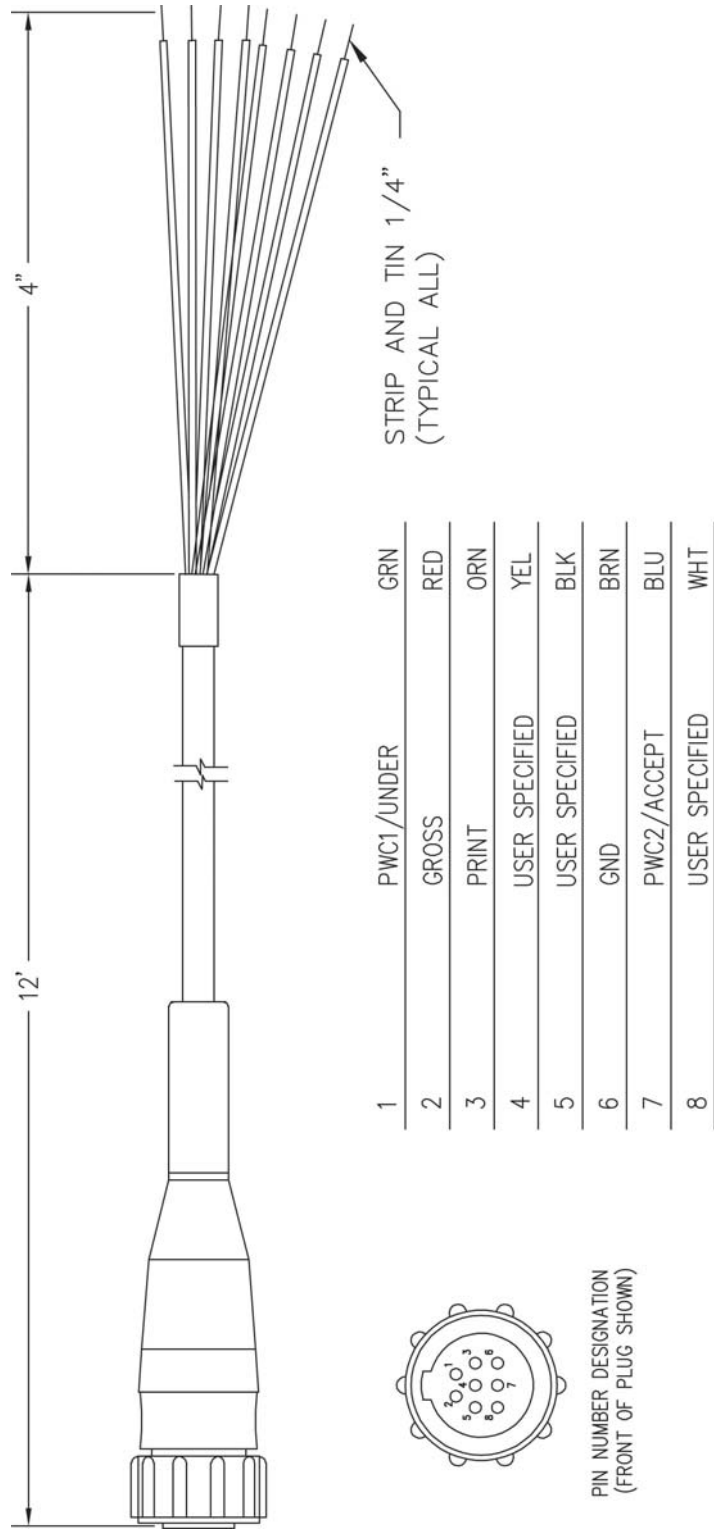

Figure No. 11

Optically Isolated Inputs

The 212/212X has four programmable inputs that may be used to remotely initiate various functions within the indicator. These inputs are accessed via a terminal block (P3) on the back of the PC board. See Figure No. 13 for the connector location and input labels. Note that the DFC feature defines terminal 1 as Start and terminal 2 as Pause.

P3 Terminal	Board Label	DFC Feature
1	Gross	Start
2	Print	Pause
3	Zero	Zero
4	Tare	Tare
5	COM	COM

NOTE: The input must be connected to COM to initiate the function.

Optically Isolated Outputs

(Requires additional hardware)

Preset Weight Comparator Logic Level Output

If desired, you may use the optically isolated outputs from your 212/212X indicators' preset weight comparators to remotely (up to 100 feet) control peripheral devices used to manage the flow of material or signal when the weight is within preset limits.

J7 (VP/VCC) – REMOTE OUT SRC (SOURCE) JUMPER

The Remote Output SRC jumper J7, when connected, allows the 212/212X indicator to supply (source) VP (15VDC) or VCC (5vdc) to a solid-state relay or other load of 200 ohms or greater. The positive connection from the relays must be connected to the PWC connector negative wire from the relays to the GND pin. See Figure No. 13 for jumper and REMOTE OUTPUT connector location.

For completely isolated outputs, J7 must be open (positioned on one plug-in pin only or removed) and the user must provide 12 to 24 VDC to the SRC pin and a ground return to the load. The load must still be 200 ohms or greater.

Optional DC Output Relay Board

The optional DC Output Relay Board in an external junction box for use with the 212/212X indicator. The RB4-DCOUT contains one board and supports four outputs (jumper selectable). The relay board used is a (Cardinal p/n 8539-C062-1A). Connect devices to be controlled as shown in Figure No.12.

The individual relays can be configured to be on (closed) or off (open) at weights under the preset weight then switch at the preset weight from on-to-off or off-to-on by setting the under weight condition to on or off during setup and calibration or setup review. Refer to “*D OUT*” (Digital Output) section of this manual for more information.

OUTPUT (closed)	3 to 60VDC @ 3A maximum for each plug-in relay
CONTROL INPUT	VP (15VDC) or VCC (5VDC) from the 212/212X main pc board P3-2, 3 or 4
CONNECTION	Removable plug-in screw terminals for up to 14 AWG wire

NOTE: All relays are the normally open type that will open when power to indicator is lost.

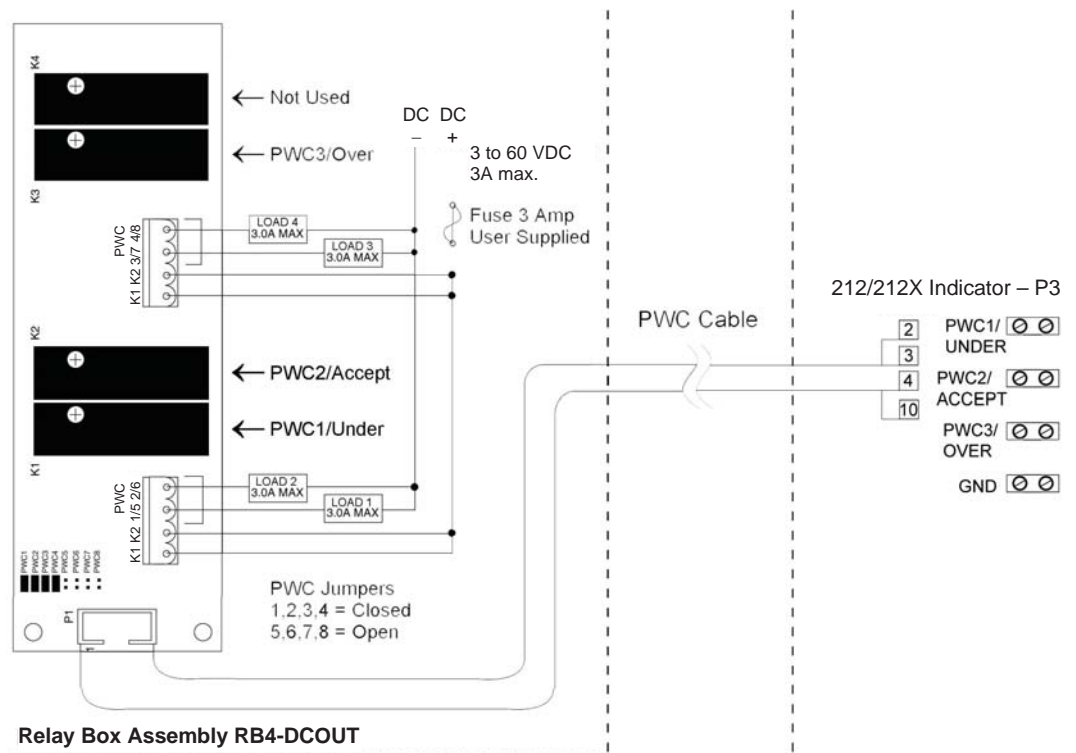

Figure No. 12

Main PCB (Printed Circuit Board)

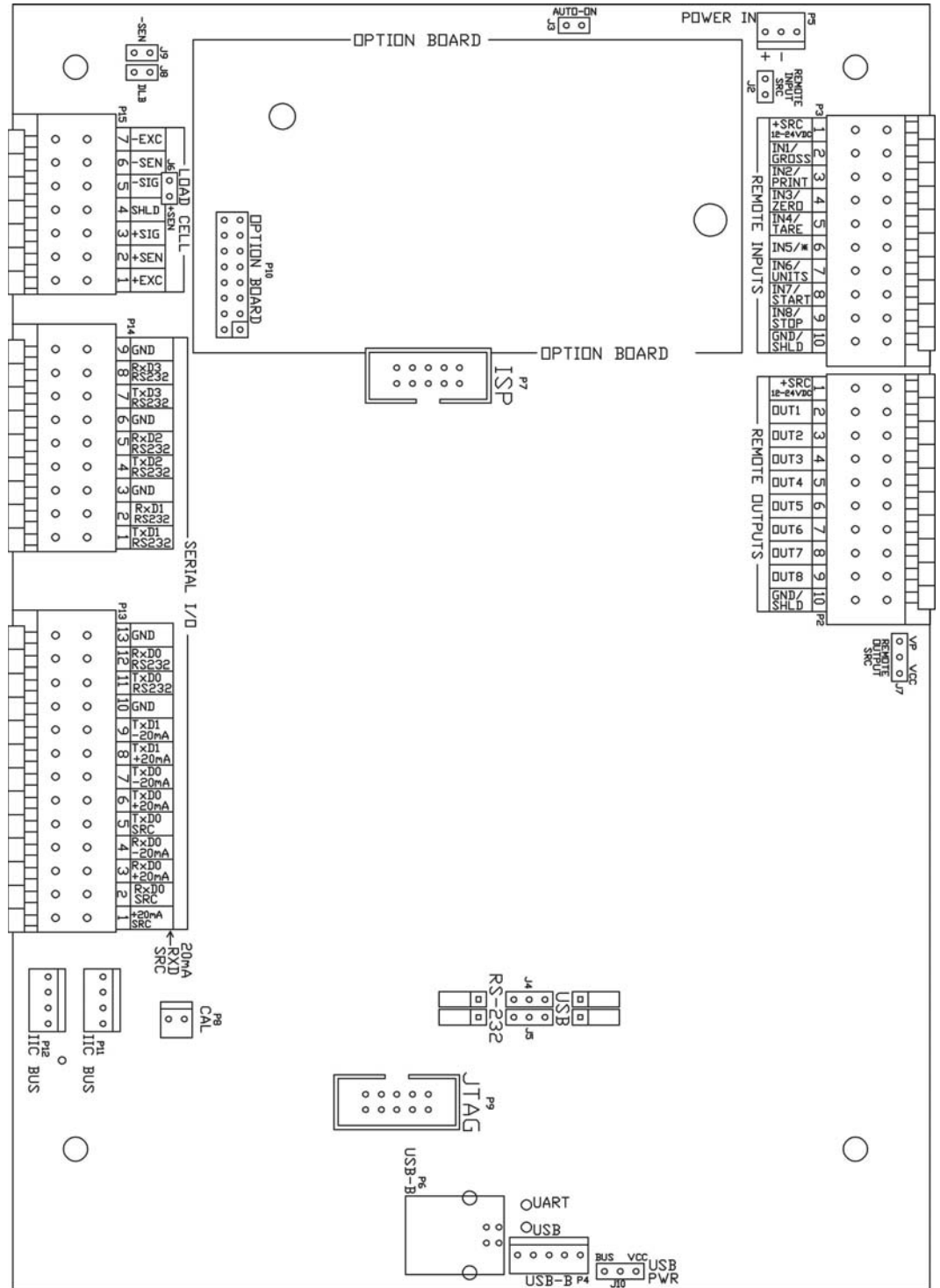

Figure No. 13

Main PCB Jumpers

J2 – REMOTE INPUT SRC (SOURCE)

The Remote Input SRC jumper J2, when connected, allows the 212/212X indicator to supply (source) 12-24VDC to a solid-state relay or other load of 200 ohms or greater. The positive connection from the relays must be connected to the remote input connector pins and the negative wire from the relays to the GND/SHLD pin.

J3 – AUTO-ON JUMPER

The AUTO-ON jumper J3, when connected, will cause the indicator to power on automatically whenever power is applied to the power input connector. If power is lost momentarily and then reapplied, the indicator will turn on without pressing the **ON/OFF** key.

J4 AND J5 – RS-232/USB PORT

These jumpers control whether COM3 is RS-232 and uses Serial I/O P14 (pins 7, 8, & 9) or USB and uses the USB-B header, P4 or USB-B port, P6.

J6 (+SEN) and J9 (-SEN) – Sense Jumpers

If the sense leads are NOT used, you must install plug-in jumpers at J6 and J9 adjacent to the terminal block. These jumpers attach the sense leads to the excitation leads. If sense leads ARE used (as in motor truck scales), these plug-in jumpers should be positioned on one plug-in pin only or removed and stored for later use.

J8 – DLB (Dead Load Boost Jumper)

For very low dead loads (less than 10% of the combined load cell capacity) connect the dead load boost jumper J8 on the printed circuit board.

J7 – REMOTE OUTPUT SRC (Source)

The Remote Output SRC jumper J7, when connected, allows the 212/212X indicator to supply (source) VP (15VDC) or VCC (5vdc) to a solid-state relay or other load of 200 ohms or greater. The positive connection from the relays must be connected to the remote output connector pins and the negative wire from the relays to the GND/SHLD pin.

J10 – USB PWR

(Not Applicable)

2.2. Indicator Setup

Your Model 212/212X indicator has been thoroughly tested and configured before being shipped to you. If the indicator is being connected to a scale for the first time or re-configuration is necessary for other reasons, proceed as indicated.

Setup Data Entry



DO NOT operate the keypad with pointed objects (pencils, pens, etc). Damage to keypad resulting from this practice is **NOT** covered under warranty.

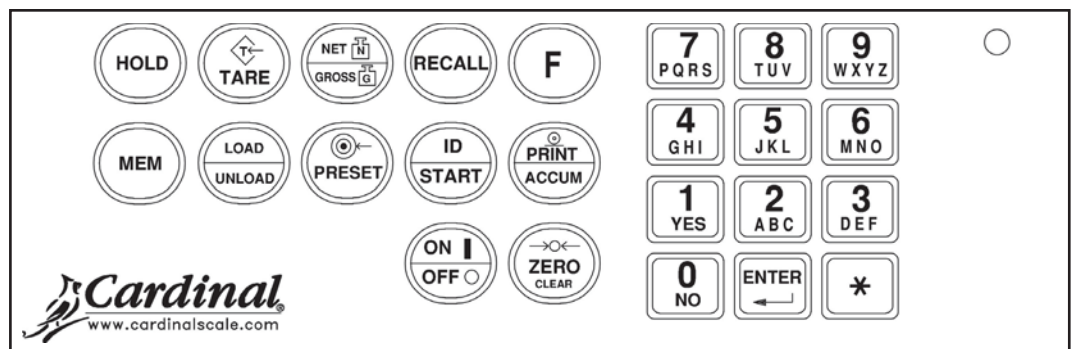

Figure No. 14

During the indicator setup and configuration process it will be necessary to enter operational parameters via the 212/212X keypad.

- Press the **F** key and then the **0/NO** key to enter quick calibration or setup and configuration.
- Press the **ENTER** key to step through the parameters in each menu.
- With a setting for a parameter displayed, press the **ENTER** key alone to save the displayed setting and advance to the next prompt.
- To change a setting, enter a new value and press the **ENTER** key. This will save the new value and advance to the next prompt.
- Pressing the * (asterisk) key will "backup" to the previous prompt.



NOTE: Setup may be interrupted at any time. ALL data previously entered and finalized with the ENTER key will be retained in the non-volatile memory.

To exit setup, press the * key with any menu selection displayed or cycle power at any time (press the **ON/OFF** key twice).

Quick Calibration

1. Press the **ON/OFF** key to turn the indicator ON.
2. Press the **F** key (display will show *F-*) and then press the **0/NO** key.
3. The display will change to the *QUICAL* prompt.
4. With *QUICAL* displayed, press the **ENTER** key. The display will change to show the current setting *NO*.
5. Press the **1/YES** key and then press the **ENTER** key to continue to the *AG BAR* prompt.

AG BAR (Ag Weigh Bar Selection)

1. Press the **ENTER** key. The current setting will be displayed.
2. If the setting displayed is acceptable, press the **ENTER** key again to save it and advance to the *CELLS=* prompt.
3. Otherwise, using the numeric keys enter a new load cell number (allowable numbers are 1 to 22) from the Quick Calibration Weigh Bar Table on page 43 and then press the **ENTER** key to save it.
4. The display will change to the *CELLS=* prompt.

CELLS= (Number of Load Cells)

1. Press the **ENTER** key to show the current setting.
2. If the setting displayed is acceptable, press the **ENTER** key again to save it and advance to the *INT=* prompt.
3. Otherwise, use the numeric keys enter a new setting (allowable settings for are 1 to 10) and then press the **ENTER** key to save it.
4. The display will change to show the *INT=* prompt.

INT= (Interval Setting)

1. Press the **ENTER** key to show the current setting.
2. If the setting displayed is acceptable, press the **ENTER** key again to save it and advance to the *CRP=* prompt.
3. Otherwise, use the numeric keys to enter a new setting (allowable settings are: 1 through 99) and then press the **ENTER** key to save it.
4. The display will change to the *CELLS=* prompt.

***CAP=* (Capacity)**

1. Press the **ENTER** key to show the current setting.
2. If the setting displayed is acceptable, press the **ENTER** key again to save it and advance to the *CAL P* prompt.
3. Otherwise, use the numeric keys to enter a new setting (allowable settings are: 1 through 999,999) and then press the **ENTER** key to save it.
4. The display will change to the *CAL P* prompt.

***CAL P* (Calibrate)**

1. With *CAL P* displayed, press the **ENTER** key. The display will change to show the current setting *NO*.
2. To save the new Quick Calibration settings and calibrate* the scale, press the **1/YES** key and then press the **ENTER** key.
3. Starting at the left and proceeding right, a series of dashes will appear on the display.
4. Next, starting at the left and proceeding right, the dashes will disappear, after which the display will change to the weight display mode.
5. To skip calibrating the scale and exit Quick Calibration, press the **ENTER** key to select *NO*.
6. The display will return to the weight display mode.



IMPORTANT! If *NO* is selected for the *CAL P* prompt, (skipping calibration and exiting Quick Calibration) it should be noted that the new quick calibration settings selected **WILL NOT BE SAVED!**

- * The empty scale weight is established in order to determine when the scale is over capacity. If calibrating with weight on the scale is necessary, we recommend that you later calibrate again once the scale is empty in order to establish a correct empty scale weight.

Quick Calibration Weigh Bar Table

Cardinal Scale Load Cells

1	AG750
2	AG1.5K
3	AG2.5K
4	AG7.5K
5	AG12.5K
6	AG12.5KL
7	AG15K
8	AG18K
9	AG20K
10	AG25K

Avery Weigh-Tronix Load Cells

11	PN 21773-xxxx Bracket (1" cell diameter)
12	PN 21863-xxxx Bracket (2.125" diameter)
13	PN 21619-xxxx Bracket (2.125" diameter)
14	PN 53750-xxxx Bracket (2.5" diameter)
15	PN 13234-xxxx Bracket (2.25" diameter)
16	PN 17028-xxxx Bracket (2.25" dual diameter)
17	PN 20095-xxxx Bracket (2.25" dual diameter)

Digi-Star Load Cells

18	2.125DB
19	CT 10K-21'
20	2.5DB
21	CT 30K T.C.-30'
22	CT 50K T.C.-30'

Full Setup and Configuration

1. Press the **ON/OFF** key to turn the indicator ON.
2. Press the **F** key (display will show *F-*) and then press the **O/NO** key.
3. The display will change to the *QUICAL* prompt.
4. With *QUICAL* displayed, press the **ENTER** key. The display will change to show the current setting *NO*.
6. Press the **ENTER** key.
7. The *SETUP* menu prompt will be displayed.
8. Proceed with the setup and configuration pressing the **F** key to step to the beginning point of each setup section.

<i>SETUP</i>	See Note Below	Setup Mode (starts at <i>USA=</i> prompt)
<i>A-D</i>	<i>A-D?</i>	Analog to Digital Filtering (starts at <i>DFLT=</i> prompt)
<i>CAL</i>	<i>CAL?</i>	Calibration (starts at <i>CMODE=</i> prompt)
<i>SIO</i>	<i>SIO?</i>	Serial Input/Output (starts at <i>BAUD=</i> prompt)
<i>PRINT</i>	<i>PRINT?</i>	Print Tab Settings (starts at <i>PORT=</i> prompt)
<i>F SPAN</i>	<i>FSPAN?</i>	Fine Span Adjustment
<i>HI RES</i>	<i>HIRES?</i>	Display High Resolution Weight
<i>LOCOUT</i>	<i>LCOUT?</i>	Key Lockout Feature Setup

NOTE: With the exception of the *SETUP* menu prompt, the prompts displayed for each menu section are different if you press the **F** key to advance to the next menu instead of pressing the **ENTER** key to step through the prompts of each section.

For example, if you press the **F** key with the *SETUP* displayed, the next prompt displayed will be *A-D*. If you step through the setup prompts by pressing the **ENTER** key, the next prompt displayed will be *A-D?*.

Note that at a prompt with the question mark (*?*) displayed, you must press the **ENTER** key, the **1/YES** key and then the **ENTER** key again to proceed with that section.

To skip the section and advance to the next menu selection, press the **ENTER** key twice.

Settings

SETUP

USA= (Domestic or International)

With *SETUP* displayed, press the **ENTER** key. The display will change to *USA=*. Press the **ENTER** key to show the current setting. If the setting displayed is acceptable, press the **ENTER** key again to save it. Otherwise, using the numeric keys, **0/NO** or **1/YES**, enter the new setting and then press the **ENTER** key to save it.

YES (Domestic)

DATE= mm/dd/yy

TRL= NO

CRP + 4% to OC

NO (International)

DATE= dd/mm/yy

TRL= YES

CRP + 9 grads to OC

PT printed with tare

Lamp test on power up

UNIT1= (Weighing Unit 1)

Press the **ENTER** key to show the current setting. If the setting displayed is acceptable, press the **ENTER** key again to save it. Otherwise, use the numeric keys to enter a new setting and then press the **ENTER** key to save it. Allowable settings are 0 to 6.

0 = none

1 = tn (tons)

2 = g (grams)

3 = lb (pounds)

4 = oz (ounces)

5 = kg (kilograms)

6 = tonnes (metric tons)

INT= (Interval Setting)

Press the **ENTER** key to show the current setting. If the setting displayed is acceptable, press the **ENTER** key again to save it. Otherwise, use the numeric keys to enter a new setting and then press the **ENTER** key to save it. Allowable settings are: 1 through 99.

DPP= (Decimal Point Setting)

NOTE: This prompt will ONLY be displayed if Interval is less than 10.

Press the **ENTER** key to show the current setting. If the setting displayed is acceptable, press the **ENTER** key again to save it. Otherwise, use the numeric keys to enter a new setting and then press the **ENTER** key to save it. Allowable settings are 0 to 3.

0 = XXXXXX 1 = XXXXX.X
2 = XXXX.XX 3 = XXX.XXX

CAP= (Capacity)

Press the **ENTER** key to show the current setting. If the setting displayed is acceptable, press the **ENTER** key again to save it. Otherwise, use the numeric keys to enter a new setting and then press the **ENTER** key to save it. Allowable settings are: 1 through 999,999.

UNIT2= (Weighing Unit 2)

Press the **ENTER** key to show the current setting. If the setting displayed is acceptable, press the **ENTER** key again to save it. Otherwise, use the numeric keys to enter a new setting and then press the **ENTER** key to save it. Allowable settings are 0 to 6.

0 = none 1 = tn (tons) 2 = g (grams)
3 = lb (pounds) 4 = oz (ounces) 5 = kg (kilograms)
6 = tonnes (metric tons)



NOTE: The selection for *UNIT2* can not be the same as *UNIT1*. In addition, dependent upon the selection for *UNIT1*, the interval and decimal point settings, not all unit combinations are available.

TRA= (Zero Tracking Range)

Press the **ENTER** key to show the current setting assigned to the Automatic Zero Tracking Range. This is the setting in scale divisions that will be automatically zeroed off. If the setting displayed is acceptable, press the **ENTER** key again to save it. Otherwise, use the numeric keys to enter a new setting and then press the **ENTER** key to save it. Allowable settings are 0 (disables Zero Tracking), 0.5, or 1 through 9.

TRL= (4% Zero Range)

Press the **ENTER** key to show the current setting. If the setting displayed is acceptable, press the **ENTER** key again to save it. Otherwise, using the numeric keys, **0/NO** or **1/YES**, enter the new setting and then press the **ENTER** key to save it.

TRL=YES

4% of scale capacity

TRL=NO

Full capacity (no limit)

PUO= (Power-Up Zero Feature)

Press the **ENTER** key to show the current setting. If the setting displayed is acceptable, press the **ENTER** key again to save it. Otherwise, using the numeric keys, **0/NO** or **1/YES**, enter the new setting and then press the **ENTER** key to save it.

PUO=YESAutomatic Re-Zero on
Power-Up**PUO=NO**

No Re-Zero on Power-Up

TD = (12 or 24 Time Format)

Press the **ENTER** key to show the current setting. If the setting displayed is acceptable, press the **ENTER** key again to save it. Otherwise, use the numeric keys to enter a new setting and then press the **ENTER** key to save it. Allowable settings are 12 or 24.

TD=1212 hour clock
(3PM displays 3:00)**TD=24**24 hour clock
(3PM displays 15:00)

NOTE: When using the 24 hour format, 12 is added to all times after noon, i.e. 3 PM would be 1500.

D OUT= X,Y (Digital Output)

Press the **ENTER** key to show the current setting. If the setting displayed is acceptable, press the **ENTER** key again to save it. Otherwise, use the numeric keys to enter the X, Y settings for the Digital Output, and then press the **ENTER** key to save it.

where:

X = State below cutoff

(0=Output connected to common, 1=Output not connected to common)

Y = Preset Number or Digital Fill Control Mode

0 = Digital Output is disabled

Preset Weigh Comparator Feature*

- 1 = Low State before cutoff with 1 active Preset
- 2 = Low State before cutoff with 2 active Presets
- 3 = Low State before cutoff with 3 active Presets
- 11 = High state before cutoff with 1 active Preset
- 12 = High state before cutoff with 2 active Presets
- 13 = High state before cutoff with 3 active Presets

Digital Fill Control Feature**

- 4 = Low State before cutoff on Digital Fill Control Mode
- 14 = High state before cutoff on Digital Fill Control Mode

* If 1, 2, 3, 11, 12 or 13 is selected for *D OUT=*, proceed to the setup prompt *R-HLD=* to continue setup.

** If 4 or 14 is selected for *D OUT=*, proceed to the setup prompt *FIL-RR* to continue setup.

FIL-AA (Digital Fill Control Auto-Accumulate)

Press the **ENTER** key to show the current setting. If the setting displayed is acceptable, press the **ENTER** key again to save it. Otherwise, using the numeric keys, **0/NO** or **1/YES**, enter the new setting and then press the **ENTER** key to save it.

PURGE= (Number of Fill Cycles before feeder will be manually purged)

Press the **ENTER** key to show the current setting. If the setting displayed is acceptable, press the **ENTER** key again to save it. Otherwise, using the numeric keys, enter the new setting and then press the **ENTER** key to save it. Allowable settings are 0 to 99 with 0 disabling the Purge.

- If PURGE is enabled (*PURGE=1 TO 99*), proceed to the setup prompt *P-WGT=* to continue setup.
- If PURGE is disabled (*PURGE=0*), proceed to the setup prompt *SPEED* to continue setup.

P-WGT= (Purge Weight – amount of material contained in feeder before purge)

Press the **ENTER** key to show the current setting. If the setting displayed is acceptable, press the **ENTER** key again to save it. Otherwise, using the numeric keys, enter the new setting and then press the **ENTER** key to save it.

SPEED= (Digital Fill Control – Number of Speeds)

The 212/212X Digital Fill Control may be configured for either single speed (*SPEED=1*) or two speed (*SPEED=2*) filling operation.

Press the **ENTER** key to show the current setting. If the setting displayed is acceptable, press the **ENTER** key again to save it. Otherwise, using the numeric keys, enter the new setting and then press the **ENTER** key to save it. Allowable settings are 1 or 2.

1. If **SINGLE SPEED OPERATION** is selected (*SPEED=1*), proceed to the setup prompt *A-TRIM* to continue setup.
2. If **TWO SPEED OPERATION** is selected (*SPEED=2*), proceed to the setup prompt *GATE=* to continue setup.

GATE= (Gate Sequence)

NOTE: This selection requires two speed operation (SPEED=2).

Press the **ENTER** key to show the current setting. If the setting displayed is acceptable, press the **ENTER** key again to save it and proceed to the setup prompt is *R-TRIM*. Otherwise, using the numeric keys, enter the new setting and then press the **ENTER** key to save it. Allowable settings are 1, 2, or 3.

GATE= 1 (AB->B)

The *AB->B* selection will begin the operation with both outputs on until the weight reaches the *FAST=* value. At that weight, the “A” (fast) output will be turned off. The “B” (slow) output will remain on until the *SLOW=* (final preset wt.) weight is reached. At that weight, the “B” (slow) output will be turned off.

GATE= 2 (A->B)

With *A->B* selected, the operation will begin with only the “A” (fast) output on until the weight reaches the *FAST=* value. At that weight, the “A” (fast) output will be turned off and the “B” (slow) output will be turned on. The “B” (slow) output will remain on until the *SLOW=* (final preset wt.) weight is reached. At that weight, the “B” (slow) output will be turned off.

GATE= 3 (CHTR, Chatter)

The Chatter Gate selection and will control one relay. It begins the operation with the “A” (fast) output on until the weight reaches the *FAST=* value. At that weight, the “A” (fast) output will be turned off. The “A” (now as slow) output will then be turned on for a preset time (*CHATTER=*, 0 to 99.9 seconds, set at the DFC PRESET PARAMETERS MENU). The “A” (slow) output will be turned off and the weight value will be compared to the *SLOW=* (final preset wt.) value less the *TRIM=* value. This will be repeated until the weight is equal to or greater than the *SLOW=* (final preset wt.) value less the *TRIM=* value.

A-TRIM (Auto-Trim)

The trim weight is a weight value used to compensate for material that will continue to flow after a “stop” action has been initiated. The stop action will be initiated at the preset weight value minus the trim weight value. A manual trim value for the material can be entered, after exiting SETUP, by pressing the **PRESET** key and selecting *TRIM=*. If auto trim is selected (*A TRIM=YES*), trim weight compensation will be automatically adjusted after each fill, based on the difference between the preset weight and the weight actually filled. If automatic trim is not selected (*A TRIM=NO*), the manually entered trim weight value will not be automatically adjusted after each fill.

Press the **ENTER** key to show the current value. If the setting displayed is acceptable, press the **ENTER** key again to save it. Otherwise, using the numeric keys, **0/NO** or **1/YES**, enter the new setting and then press the **ENTER** key to save it.

A-PRNT (Auto-Print)

The Auto-Print feature will cause an optional printer to automatically record the total weight, time, and date of the fill at the conclusion of the fill.

Press the **ENTER** key to show the current value. If the setting displayed is acceptable, press the **ENTER** key again to save it. Otherwise, using the numeric keys, **0/NO** or **1/YES**, enter the new setting and then press the **ENTER** key to save it.

DFCEND (Digital Fill Control Ending Message)

NOTE: This selection requires two speed operation (*SPEED=2*).

This feature will enable/disable the Digital Fill Control ending message. If enabled, the indicator will display (*DONE*) upon the conclusion of the fill. Note that this message will remain on the display until a key is pressed.

Press the **ENTER** key to show the current value. If the setting displayed is acceptable, press the **ENTER** key again to save it. Otherwise, using the numeric keys, **0/NO** or **1/YES**, enter the new setting and then press the **ENTER** key to save it.

***A-HLD*=(Auto-Hold Feature for Animal Weighing)**

Press the **ENTER** key to show the current setting. If the setting displayed is acceptable, press the **ENTER** key again to save it. Otherwise, using the numeric keys, enter the new setting and then press the **ENTER** key to save it. Allowable settings are 0, 1 or 2.

- 0 = Disabled (Next setup prompt is *SLEEP*=)
- 1 = Standard Mode (Held weight is cleared 3 seconds after animal is removed)
- 2 = Advanced Mode (Held weight is not cleared. New held weight is displayed after next animal is weighed)

***THRES*=(Minimum Auto-Hold Weight)**

Press the **ENTER** key to show the current setting. If the setting displayed is acceptable, press the **ENTER** key again to save it. Otherwise, using the numeric keys, enter the new setting and then press the **ENTER** key to save it. Allowable settings are any number between 0 and scale capacity.

***A-RCC*=(Auto-Accumulate Weight)**

This feature automatically accumulates weight whenever Auto-Hold is actuated.

Press the **ENTER** key to show the current setting. If the setting displayed is acceptable, press the **ENTER** key again to save it. Otherwise, using the numeric keys, enter **0/NO** or **1/YES** and then press the **ENTER** key to save it.

***BALTOL* (Balance Tolerance)**

This feature corrects instability when weighing animals. The entered tolerance setting is the maximum amount the scale can fluctuate and still allow the auto-hold to actuate.

Press the **ENTER** key to show the current setting. If the setting displayed is acceptable, press the **ENTER** key again to save it. Otherwise, using the numeric keys, enter the new setting and then press the **ENTER** key to save it. Allowable settings are 0 to 99.

SLEEP= (Sleep Mode)

The Sleep Mode feature conserves battery power when the indicator remains unused for a period of approximately 1 to 9 minutes. When enabled, the load cell excitation will be reduced and the display will be blank.

The Sleep Mode feature requires the indicator to remain at the center of zero to activate, unlike Automatic Shutoff feature which only requires no motion. Weight placed on the scale will activate the indicator and return it to the weight mode.

Press the **ENTER** key to show the current setting. If the setting displayed is acceptable, press the **ENTER** key again to save it. Otherwise, use the numeric keys to enter a new setting and then press the **ENTER** key to save it. Allowable settings are 0 through 9 with 0 disabling Sleep Mode.

A OFF= (Auto Shutoff)

The Automatic Shutoff feature will automatically turn the indicator off after a period of approximately 1 to 9 minutes of inactivity to prolong battery life. You must press the **ON/OFF** key to turn the indicator back on.

Press the **ENTER** key to show the current setting. If the setting displayed is acceptable, press the **ENTER** key again to save it. Otherwise, use the numeric keys to enter a new setting and then press the **ENTER** key to save it. Allowable settings are 0 through 9 with 0 disabling Auto Shutoff.

CLTAR= (Clear Tare)

The Clear Tare feature allows the indicator to clear the Stored Tare weight when the Net weight goes below a value greater than 1/2 the stored tare weight or goes below zero (a negative net weight after display of a positive net weight). With this feature enabled, the operator must re-set the tare after completion of a transaction when the load (container plus item) is removed from the scale.

Press the **ENTER** key to show the current setting. If the setting displayed is acceptable, press the **ENTER** key again to save it. Otherwise, using the numeric keys, **0/NO** or **1/YES**, enter the new setting and then press the **ENTER** key to save it.

CLTAR= YES

Automatically clears Stored Tare when Net weight goes below zero

CLTAR= NO

Stored Tare is not cleared when Net weight goes below zero

The following is a typical example of the Clear Tare feature in use.

1. Place container on scale, then press **TARE** key (with diamond "T" symbol).
2. Load container with item to be weighed and perform normal weighing operation.
3. Remove load (item *AND* container) from scale.
4. Scale weight returns to below zero (weight of container) and is then reset to zero.
5. Operator is required to repeat step 1 before next weighing operation.

A CLR= (Auto Clear ID)

The *A CLR= (Auto Clear ID)* prompt determines whether the ID is automatically cleared after printing the ticket. Note that it is only displayed when *ID= YES* is selected.

With the display showing *A CLR=*, press the **ENTER** key to show the current setting. If the setting displayed is acceptable, press the **ENTER** key again to save it. Otherwise, using the numeric keys, **0/NO** or **1/YES**, enter the new setting and then press the **ENTER** key to save it.

A CLR= YES

Automatically clears the ID
after the ticket has printed.

A CLR= NO

ID is not cleared when
ticket prints and can be
used for next transaction.

Analog to Digital Filtering

A-D (A-D?)

SERSCL – (Remote Indicator Setup)

If the indicator is to function as a remote indicator, press the **YES** key at the *SERSCL* prompt. If not then press the **NO** key at the prompt.

If *SERSCL* was set to **YES** then, an additional prompt has also been added in the *SID* section for selecting the port for the LOCAL/REMOTE communications. At the *LRP* prompt enter either **1** for port 1 or **3** if the optional 2XX-RS232 card is being used.

DFLT= (Digital Filtering)

With *A-D (A-D?)* displayed, press the **ENTER** key. The display will change to *DFLT=*. Press the **ENTER** key to show the current setting. If the setting displayed is acceptable, press the **ENTER** key to save it. Otherwise, using the numeric keys enter the new setting and then press the **ENTER** key to save it. Allowable settings are 0, 1, 2 or 3.

Note, that if you select 3 (Custom Filtering) two additional prompts will be displayed.

- 0* = Filter Level = 2, Break Range = 1
- 1* = Filter Level = 6, Break Range = 12, Sample Rate = 2
- 2* = Filter Level = 20, Break Range = 12, Sample Rate = 1
- 3 = CUSTOM FILTERING

NOTE: The prompts, *F=* (Filter Level) and *B=* (Break Range) will only be displayed if you selected 3 (Custom Filtering) for the *DFLT=* (Digital Filtering) prompt.

* Digital Filtering (*DFLT=*) selections 0, 1 and 2 have fixed factory settings for Filter Level, Break Range and Sample Rate.

F= (Filter Level)

The Filter Level is a number from 1 to 99 that corresponds to the level of filtering with 1 the least and 99 being the greatest filtering.

Press the **ENTER** key to show the current setting. If the setting displayed is acceptable, press the **ENTER** key again to save it. Otherwise, use the numeric keys to enter a new setting and then press the **ENTER** key to save it. Allowable settings are 1 to 99.

B= (Break Range)

The Break Range is a number from 1 to 255 that corresponds to the number of division changes to break out of the filtering.

Press the **ENTER** key to show the current setting. If the setting displayed is acceptable, press the **ENTER** key to save it. Otherwise, use the numeric keys to enter a new setting and then press the **ENTER** key to save it. Allowable settings are 0 to 255 with 0 disabling the Break Range feature.

SR= (Sample Rate)

The Sample Rate is the measurement rate, in samples per second, of the analog-to-digital converter.

Press the **ENTER** key to show the current setting. If the setting displayed is acceptable, press the **ENTER** key to save it. Otherwise, use the numeric keys to enter a new setting and then press the **ENTER** key to save it. Allowable settings are 1 to 100.

UNS= (Motion Range)

The Motion Range is the number of divisions of change permitted before indicating unstable weight.

Press the **ENTER** key to show the current setting. If the setting displayed is acceptable, press the **ENTER** key to save it. Otherwise, use the numeric keys to enter a new setting and then press the **ENTER** key to save it. Allowable settings are 0 through 99.

5 \bar{C} = (Stable Count)

The Stable Count is the number of consecutive stable weight readings before indicating stable weight. This helps filter weight readings for stability for use with Auto Print on Balance, or and anything trying to capture stable weight.

Press the **ENTER** key to show the current setting. If the setting displayed is acceptable, press the **ENTER** key to save it. Otherwise, use the numeric keys to enter a new setting and then press the **ENTER** key to save it. Allowable settings are 3 through 255.

Filter Setting Recommendations

Non Critical Sample Rate

If the sample rate is not critical, as in static weighing, set:

$$DFLT = 0^* (F=2, B=1),$$

$$DFLT = 1^* (F=6, B=12, SR=2), \text{ or}$$

$$DFLT = 2^* (F=20, B=12, SR=1).$$

* Digital Filtering ($DFLT$) selections 0, 1 and 2 have fixed factory settings for Filter Level, Break Range and Sample Rate.

Critical Sample Rate

If the sample rate is critical, as in a filling operation, use Custom Filtering (set $DFLT$ to "3").

1. SR = SAMPLE RATE (1 to 120 samples/second) determination:

Set the sample rate as close as possible to produce a display graduation change for every graduation of material added to the scale.

$$\frac{\text{Material Flow Rate (lbs/second)}}{\text{Resolution}} =$$

$$\text{EXAMPLE: } \frac{100\text{lbs/sec}}{10\text{lbs}} = 10\text{s/s} = SR$$

2. B = BREAK RANGE (1 to 255 graduations) determination:

Turn the filtering off by setting the $DFLT$ setting to "0". Operate the system as it will be normally used and, by observation, determine the number of grads of instability that needs to be filtered out. Set the break range (B) to that value.

$$\frac{\text{Weight Change}}{\text{Graduation Value}} = B$$

EXAMPLE: 20,000 x 10lb capacity scale with 800lb variation in the weight display.

$$\frac{800}{10} = B = 80$$

3. F = FILTER SETTING (1 to 99) determination: Set to desired results.
4. If stability is unacceptable with any setting of F , reduce the sample rate and/or increase the break range, B setting for increased filtering.

Calibration

CAL (CALP)

With *CAL (CALP)* displayed, press the **ENTER** key. The display will change to show the current setting *NO*. If calibration is desired, press the **1/YES** key and then press the **ENTER** key to continue to the *CMODE=* prompt.

Otherwise press the **ENTER** key to advance to the *SID* setup prompt.

CMODE= (Calibration Mode Selection)

Press the **ENTER** key to show the current setting. If the setting displayed is acceptable, press the **ENTER** key again to save it.

Otherwise, using the numeric keys enter the new setting and then press the **ENTER** key to save it and advance to the *AG BAR* prompt.

Allowable settings are 1, 2 or 3.

- 1 = Ag Weigh Bar Table Selection (most common)
- 2 = Enter Load Cell Specs (useful if your load cell is not listed in the table) – Refer to the section Enter Load Cell Specs (Calibration Mode Selection 2)
- 3 = Other Calibration Modes

AG BAR (Ag Weigh Bar Table Selection)

5. Press the **ENTER** key to show the current setting.
6. If the setting displayed is acceptable, press the **ENTER** key again to save it and advance to the *CELLS=* prompt.
7. Otherwise, using the numeric keys enter the new setting and then press the **ENTER** key to save it and advance to the *CELLS=* prompt.

Allowable settings are 1 to 22 and represent the load cells from the Weigh Bar Table (Calibration Mode Selection 1) on page 67.

CELLS= (Number of Load Cells)

5. Press the **ENTER** key to show the current setting.
6. If the setting displayed is acceptable, press the **ENTER** key again to save it and advance to the *SD* setup prompt.
7. Otherwise, using the numeric keys enter a new setting and then press the **ENTER** key.

Allowable settings for *CELLS=* are 1 to 10.

8. Starting at the left and proceeding right, a series of dashes will appear on the display.
9. Next, starting at the left and proceeding right, the dashes will disappear, after which the display will show: *SD?*



IMPORTANT! When calibrating using mode 1, the empty scale weight is established in order to determine when the scale is over capacity. If calibrating with weight on the scale is necessary, we recommend that you later calibrate again once the scale is empty in order to establish a correct empty scale weight.

Weigh Bar Table (Calibration Mode Selection 1)**Cardinal Scale Load Cells**

1	AG750
2	AG1.5K
3	AG2.5K
4	AG7.5K
5	AG12.5K
6	AG12.5KL
7	AG15K
8	AG18K
9	AG20K
10	AG25K

Avery Weigh-Tronix Load Cells

11	PN 21773-xxxx Bracket (1" cell diameter)
12	PN 21863-xxxx Bracket (2.125" diameter)
13	PN 21619-xxxx Bracket (2.125" diameter) PN 21594-xxxx Bracket (2.125" diameter)
14	PN 53750-xxxx Bracket (2.5" diameter)
15	PN 13234-xxxx Bracket (2.25" diameter)
16	PN 17028-xxxx Bracket (2.25" dual diameter)
17	PN 20095-xxxx Bracket (2.25" dual diameter)

Digi-Star Load Cells

18	2.125DB
19	CT 10K-21'
20	2.5DB
21	CT 30K T.C.-30'
22	CT 50K T.C.-30'

Enter Load Cell Specs (Calibration Mode Selection 2)

CAP= (Maximum Capacity of Load Cell)

Press the **ENTER** key to show the current setting. If the setting displayed is acceptable, press the **ENTER** key again to save it and advance to the *MVOLT=* prompt.

Otherwise, using the numeric keys enter the new setting 0 - 999999 and then press the **ENTER** key to save it and advance to the *MVOLT=* prompt.

MVOLT= (mV/V Load Cell Output)

Press the **ENTER** key to show the current setting. If the setting displayed is acceptable, press the **ENTER** key again to save it and advance to the *CELLS=* prompt.

Otherwise, using the numeric keys enter the new setting 0.000 – 3.000 mV/v and then press the **ENTER** key to save it and advance to the *CELLS=* prompt.

CELLS= (Number of Load Cells)

1. Press the **ENTER** key to show the current setting.
2. If the setting displayed is acceptable, press the **ENTER** key again to save it and advance to the *SID* setup prompt.
3. Otherwise, using the numeric keys enter a new setting and then press the **ENTER** key.

Allowable settings for *CELLS=* are 1 to 10.

4. Starting at the left and proceeding right, a series of dashes will appear on the display.
5. Next, starting at the left and proceeding right, the dashes will disappear, after which the display will show: *SID?*



IMPORTANT! When calibrating using mode 2, the empty scale weight is established in order to determine when the scale is over capacity. If calibrating with weight on the scale is necessary, we recommend that you later calibrate again once the scale is empty in order to establish a correct empty scale weight.

Other Calibration Modes (Calibration Mode Selection 3)

The 212/212X has five additional modes that can be used to perform calibration. Three of the modes require a test load or test weights, one requires the scale to be empty (and at zero) and the last uses the calibration "C" numbers from a previous calibration.

Dual-Point with Zero (First Zero) Calibration

This is a standard calibration method requiring one weight, an empty scale and has one conversion factor. This method uses two calibration points ($CAL1=$ and $CAL2=$) to establish a zero (no load) calibration value and to span the indicator. The two points correspond to zero weight and the test load or test weight and can be applied in any order. This method should be used for first-time calibration and complete recalibration.

$CAL1=$ – First Calibration Weight

1. The display will show $CAL1=0$. This is the first of two calibration weights. This weight could be ZERO (NO LOAD) or the TEST WEIGHTS (TEST LOAD).
2. Press the **ENTER** key to view the current setting.
3. If the first calibration weight is to be ZERO (NO LOAD), press the **ENTER** key.
4. If the first calibration weight is to be the TEST WEIGHTS (TEST LOAD), use the numeric keys to input the value of the test weights.
5. Place the weights on the scale platform, then press the **ENTER** key.
6. Starting at the left and proceeding right, a series of dashes will appear on the display.
7. Next, starting at the left and proceeding right, the dashes will disappear, after which the display will show: $CAL2=$.

CAL2= – Second Calibration Weight

1. The display will show *CAL2=0*. This is the second of two calibration weights. This weight could be ZERO (NO LOAD) or the TEST WEIGHTS (TEST LOAD).
2. Press the **ENTER** key to view the current setting.
3. If the second calibration weight is to be ZERO (NO LOAD), press the **ENTER** key.
4. If the second calibration weight is to be the TEST WEIGHTS (TEST LOAD), use the numeric keys to input the value of the test weights.
5. Place the weights on the scale platform, then press the **ENTER** key.
6. Starting at the left and proceeding right, a series of dashes will appear on the display.
7. Next, starting at the left and proceeding right, the dashes will disappear, after which the display will show: *510?*

Dual-Point without Zero (False Zero) Calibration

This calibration method requires one test weight and establishes a new conversion factor only. It is used to establish a false (temporary zero) zero without affecting the zero calibration value stored during the last calibration. This is particularly useful in tank weighing applications, where it may be impractical or impossible to completely empty the tank. This method uses two calibration points, $CAL1=$ and $CAL2=$. The value of the test weight is entered when $CAL1=$ is displayed and the **NET/GROSS** key is pressed when $CAL2=$ is displayed.

$CAL1=$ – First Calibration Weight

1. The display will show $CAL1=0$. This is the first of two calibration weights. This weight could be ZERO (NO LOAD) or the TEST WEIGHTS (TEST LOAD).
2. Press the **ENTER** key to view the current setting.
3. If the first calibration weight is to be ZERO (NO LOAD), press the **ENTER** key.
4. If the first calibration weight is to be the TEST WEIGHTS (TEST LOAD), use the numeric keys to input the value of the test weights.
5. Place the weights on the scale platform, then press the **ENTER** key.
6. Starting at the left and proceeding right, a series of dashes will appear on the display.
7. Next, starting at the left and proceeding right, the dashes will disappear, after which the display will show: $CAL2=$.

$CAL2=$ – Second Calibration Weight

1. The display will show $CAL2=0$. This is the second of two calibration steps.
2. Remove the weights on the scale platform.
3. Press the **NET/GROSS** key.
4. Starting at the left and proceeding right, a series of dashes will appear on the display.
5. Next, starting at the left and proceeding right, the dashes will disappear, after which the display will show: 510.2 .

Single-Point for Span Only (Last Zero) Calibration

This calibration method requires one test weight and establishes a new conversion factor (span) without affecting the zero calibration value stored during the last calibration. This minimizes placing and removing test weights and is especially useful when checking high capacity scales. This method uses two calibration points, $CAL1=$ and $CAL2=$. The value of the test weight is entered when $CAL1=$ is displayed and the **ZERO** key is pressed when $CAL2=$ is displayed.

$CAL1=$ – First Calibration Weight

1. The display will show $CAL1=0$. This is the first of two calibration steps.
2. Press the **ZERO** key to zero the scale.
3. Place the TEST WEIGHTS (TEST LOAD) on the scale platform.
4. Using the numeric keys input the value of the test weights.
5. Press the **ENTER** key.
6. Next, starting at the left and proceeding right, the dashes will disappear, after which the display will show: $CAL2=$.

$CAL2=$ – Second Calibration Weight

1. The display will show $CAL2=0$. This is the second of two calibration steps.
2. Remove the weights on the scale platform.
3. Press the **ZERO** key.
4. The display will show: $SIG?$.

Single-Point for Zero Only (Only Zero) Calibration

This calibration method requires no test weight, an empty scale and establishes a new zero without affecting the conversion factor (span). This is useful to regain the full range of zero limit when the dead load of the scale has changed. This would occur for example, if a guard rail has been added to the scale platform. This method uses two calibration points, $CAL1=$ and $CAL2=$. The **ENTER** key is pressed when $CAL1=$ is displayed and the **ZERO** key is pressed when $CAL2=$ is displayed.

$CAL1=$ – First Calibration Weight

1. The display will show $CAL1=0$. This is the first of two calibration steps.
2. Insure the scale is empty.
3. Press the **ENTER** key.
4. Starting at the left and proceeding right, a series of dashes will appear on the display.
5. Next, starting at the left and proceeding right, the dashes will disappear, after which the display will show: $CAL2=$.

$CAL2=$ – Second Calibration Weight

1. The display will show $CAL2=0$. This is the second of two calibration steps.
2. Press the **ZERO** key.
3. The display will advance to $SLOP$.

Calibration “C” Numbers

The calibration “C” numbers (C1, C2, C3 and C4) are displayed only during the Test mode operation and are shown at the end of the test. Each number is displayed for approximately 4 seconds, allowing you to record them. Each number may be up to three (3) digits in length. By recording these numbers you will be able to return the indicator to its present calibration settings without using test weights simply by entering the “C” numbers.

1. With \overline{CAL} displayed, press the "diamond T" TARE key.
2. At the $\overline{C1}$ prompt, press the **ENTER** key to show the current value of the C1 number.
3. If the $\overline{C1}$ number displayed is acceptable, press the **ENTER** key again to save it.
4. Otherwise, use the numeric keys to enter a new $\overline{C1}$ number and then press the **ENTER** key.
5. At the $\overline{C2}$ prompt, press the **ENTER** key to show the current value of the C2 number.
6. If the $\overline{C2}$ number displayed is acceptable, press the **ENTER** key again to save it.
7. Otherwise, use the numeric keys to enter a new $\overline{C2}$ number and then press the **ENTER** key.
8. At the $\overline{C3}$ prompt, press the **ENTER** key to show the current value of the C3 number.
9. If the $\overline{C3}$ number displayed is acceptable, press the **ENTER** key again to save it.
10. Otherwise, use the numeric keys to enter a new $\overline{C3}$ number and then press the **ENTER** key.
11. At the $\overline{C4}$ prompt, press the **ENTER** key to show the current value of the C4 number.
12. If the $\overline{C4}$ number displayed is acceptable, press the **ENTER** key again to save it.
13. Otherwise, use the numeric keys to enter a new $\overline{C4}$ number and then press the **ENTER** key.
14. The display will change to show: *5102*.

Serial Input/Output

SIO (*SIO?*)

With *SIO* (*SIO?*) displayed, press the **ENTER** key. The display will change to show the current setting "*NO*". To skip configuring the *SIO* (serial input/output) and proceed to the *PRINT?* menu, press the **ENTER** key again. To configure the *SIO*, press the numeric key **1/YES** and then the **ENTER** key. The display will change to the *BAUD=* prompt.

BAUD= (Serial Port Baud Rate)

Press the **ENTER** key to show the current setting. If the setting displayed is acceptable, press the **ENTER** key again to save it. Otherwise, use the numeric keys to enter a new baud rate for the serial ports and then press the **ENTER** key to save it. Allowable settings are:

12 = 1200 Baud	24 = 2400 Baud	48 = 4800 Baud
96 = 9600 Baud	19 = 19.2k Baud	38 = 38.4k Baud
76 = 76.8k Baud		

PRTY= (Serial Port Parity)

Press the **ENTER** key to show the current setting. If the setting displayed is acceptable, press the **ENTER** key again to save it. Otherwise, using the numeric keys enter the new setting and then press the **ENTER** key to save it. Allowable settings are 0, 1, or 2.

0 = NONE (No Parity)	1 = Odd Parity	2 = Even Parity
----------------------	----------------	-----------------

BITS= (Serial Port Data Bits)

Press the **ENTER** key to show the current setting. If the setting displayed is acceptable, press the **ENTER** key again to save it. Otherwise, using the numeric keys enter the new setting and then press the **ENTER** key to save it. Allowable settings are 7 or 8.

STOP= (Serial Port Stop Bits)

Press the **ENTER** key to show the current setting. If the setting displayed is acceptable, press the **ENTER** key again to save it. Otherwise, using the numeric keys enter the new setting and then press the **ENTER** key to save it. Allowable settings are 1 or 2.

CONT1= (Continuous Output Serial Port 1)

Press the **ENTER** key to show the current setting. If the setting displayed is acceptable, press the **ENTER** key again to save it. Otherwise, using the numeric keys, **0/NO** or **1/YES**, enter the new setting and then press the **ENTER** key to save it.

<i>CONT1=YES</i>	<i>CONT1=NO</i>
Continuous Output	No Continuous Output

If you selected Cont1=YES (Continuous Output), an additional prompt, tyPE= will be displayed.

If you selected Cont1=NO (No Continuous Output) proceed to the Weight On Demand section.

TYPE= (Continuous Output Format)

Press the **ENTER** key to show the current setting. If the setting displayed is acceptable, press the **ENTER** key again to save it. Otherwise, using the numeric keys enter the new setting and then press the **ENTER** key to save it. Allowable settings are 0, 1 or 2.

0 = SMA 1 = Cardinal Scoreboard 2 = SB-500

SMA Continuous Output Format

If SMA is selected, data will be transmitted in the following format:

<lf><s><r><n><m><f><xxxxxx.xxx><uuu><cr>

Where:

lf =	Line Feed	
s =	Flags	Z= center of Zero, O = Overcap, E = zero Error, e = weight not currently being displayed
r =	Range	1, 2, 3
n =	Mode	G = Gross, T = Tare, N = Net
m =	Motion	M = Motion, " "(blank) = no motion
f =	Custom	Custom flag
xxxxxx.xxx =	Weight	Six digits with decimal point
uuu =	Units	ton, lb, l/o, oz, t, kg, g
cr =	Carriage Return	(hex 0D)

Cardinal Scoreboard Output Format

If Cardinal Scoreboard is selected, the data will be transmitted in the following format:

```
<s><xxxxxx><d><uu><m><cc><cr>
```

Where:

s =	Sign	"-" = negative, " " (<i>blank</i>) = positive
xxxxxx =	Weight	Six digits
d =	Decimal point	Added to string if enabled in setup
uu =	Units	LB, OZ, KG, G
m =	Mode	G = Gross, N = Net
cc =	Weight Status	OC = overcap CZ = center of zero MO = motion EE = weight not currently being displayed
cr =	Carriage Return	(hex 0D)



IMPORTANT! The RD2, RD3, SB250, and SB500 scoreboards use the Cardinal Scoreboard format. When using the Traffic Light feature of the SB500, use the SB500 format.

SB500 Output Format

This format should **ONLY** be used when using the Traffic Light feature of the SB500 scoreboard.

CONT2= (Continuous Output Serial Port 2)

Press the **ENTER** key to show the current setting. If the setting displayed is acceptable, press the **ENTER** key again to save it. Otherwise, using the numeric keys, **0/NO** or **1/YES**, enter the new setting and then press the **ENTER** key to save it.

CONT2=YES

Continuous Output

CONT2=NO

No Continuous Output

If *CONT2=YES* (Continuous Output) is selected, an additional prompt, *TYPE=* will be displayed.

TYPE= (Continuous Output Format)

Press the **ENTER** key to show the current setting. If the setting displayed is acceptable, press the **ENTER** key again to save it. Otherwise, using the numeric keys enter the new setting and then press the **ENTER** key to save it. Allowable settings are .0, 1 or 2.

0 = SMA 1 = Cardinal Scoreboard 2 = SB-500

NOTE: See Continuous Output Serial Port 1, *TYPE=* for description of output formats.

LRP= (Local/Remote Port)

NOTE: This prompt will **ONLY** be displayed if *SER5CL* is set to **YES** in the *R-D* section.

Press the **ENTER** key to show the current setting. If the setting displayed is acceptable, press the **ENTER** key again to save it. Otherwise, using the numeric keys enter the new setting and then press the **ENTER** key to save it. Allowable settings are 1 or 3

1 = Indicator Port 1
3 = Port on optional 2XX-RS232 card (if installed)

Print Tab Settings

PRINT (PRINT?)

With *PRINT (PRINT?)* displayed, press the **ENTER** key. The display will change to *NO*. To skip configuring Print Tab Settings and proceed to the *FSPAN?* menu, press the **ENTER** key again. To configure Print Tab Settings, press the numeric key **1/YES** and then the **ENTER** key. After pressing the **ENTER** key the display will change to *PORT=*.

The general format for the input is A = YY.XX where A is the character identifying the data printed, YY is the number of lines down and XX is the number of columns to the right.



NOTE: Enter 00 in either the YY or XX location to disable the data from printing.

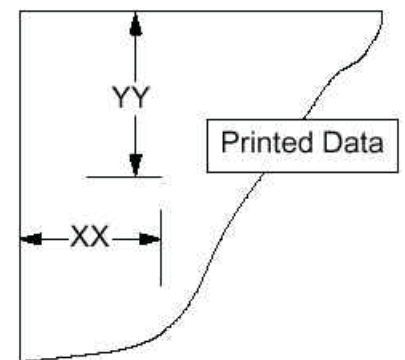

PORT= (Select Port for Printing)

Press the **ENTER** key to show the current setting. If the setting displayed is acceptable, press the **ENTER** key again to save it. Otherwise, use the numeric keys to enter a new setting and then press the **ENTER** key to save it. Allowable settings are: 1 or 2.



NOTE: Although either port can be used for the printer port, it is recommended to use the bi-directional port 1 with a bi-directional cable.

TIME= (Time Print Location)

Press the **ENTER** key to show the current setting for the location of time printing. If the setting displayed is acceptable, press the **ENTER** key again to save it. Otherwise, use the numeric keys to enter a new location and then press **ENTER** to save it.

***DATE=* (Date Print Location)**

Press the **ENTER** key to show the current setting for the location of date printing. If the setting displayed is acceptable, press the **ENTER** key again to save it. Otherwise, use the numeric keys to enter a new location and then press **ENTER** to save it.

***ID =* (ID Prompt Print Location)**

Press the **ENTER** key to show the current setting for the location of ID prompt printing. If the setting displayed is acceptable, press the **ENTER** key again to save it. Otherwise, use the numeric keys to enter a new location and then press **ENTER** to save it.

***CNC N=* (Consecutive Number Print Location)**

Press the **ENTER** key to show the current setting for the location of consecutive number printing. If the setting displayed is acceptable, press the **ENTER** key again to save it. Otherwise, use the numeric keys to enter a new location and then press **ENTER** to save it.

***GROSS=* (Gross Weight Print Location)**

Press the **ENTER** key to show the current setting for the location of Gross weight printing. If the setting displayed is acceptable, press the **ENTER** key again to save it. Otherwise, use the numeric keys to enter a new location and then press **ENTER** to save it.

***TARE=* (Tare Weight Print Location)**

Press the **ENTER** key to show the current setting for the location of Tare weight printing. If the setting displayed is acceptable, press the **ENTER** key again to save it. Otherwise, use the numeric keys to enter a new location and then press **ENTER** to save it.

***NET=* (Net Weight Print Location)**

Press the **ENTER** key to show the current setting for the location of Net weight printing. If the setting displayed is acceptable, press the **ENTER** key again to save it. Otherwise, use the numeric keys to enter a new location and then press **ENTER** to save it.

RCC= (Weight Accumulator Print Location)

Press the **ENTER** key to show the current setting for the location of printing for the currently used accumulator.

For example, if an ID is selected, it will be that ID's accumulator. If no ID is selected and Gross weight is displayed, it will be the Gross accumulator. If no ID is selected and Net weight is displayed, it will be the Net accumulator.

If the setting displayed is acceptable, press the **ENTER** key again to save it. Otherwise, use the numeric keys to enter a new location and then press **ENTER** to save it.

CRLF= (Carriage Return Line Feed) - Data Format Termination

Data transmitted from the serial I/O port can be terminated with a single carriage return and either no line feed or a single line feed command. Press the **ENTER** key to view the current setting. A "YES" displayed means the data will be terminated with a carriage return AND a line feed. A "no" displayed means the data will be terminated with a single carriage return only.

If the setting displayed is acceptable, press the **ENTER** key again to save it. Otherwise, using the numeric keys, **0/NO** or **1/YES**, enter the new setting and then press the **ENTER** key to save it.

EOP= (End-Of-Print Line Feeds)

At the end of a data transmission to a printer, the indicator can transmit a pre-selected number of line feed commands to space the paper in the printer to the desired position for withdrawal or for the next print.

Press the **ENTER** key to view the current setting. If the displayed setting is acceptable, press the **ENTER** key to save it. Otherwise, use the numeric keys to enter the new the number of End-Of-Print linefeeds and then press the **ENTER** key to save the new setting. Allowable settings are: 0 through 99...

Fine Span Adjustment



IMPORTANT! The *FSPAN* (*FSPAN?*) mode requires a load of 10% of Capacity on the scale before adjustments can be made.

FSPAN?

Fine Span Adjustment (after pressing **ENTER** at last *PRINT* prompt)

1. With *FSPAN?* displayed, press the **ENTER** key.
2. The display will change to show the current setting "NO".
3. To skip the Fine Span Adjustment and return to the *SETUP* menu, press the **ENTER** key again.
4. To perform the Fine Span Adjustment, place a calibrated test weight on the scale and press the numeric key **1/YES** and then the **ENTER** key.
5. After pressing the **ENTER** key, the display will change to show the amount of the test weight and the annunciator display will alternately flash off and on i.e. (all ON, weighing unit off, then all OFF, weighing unit ON).
6. Press the **1/YES** to increase the span OR press the **0/NO** key to decrease the span.
7. Press the ***** key to return to the previous prompt or press the **ENTER** key to exit *FSPAN?* and return to the *SETUP* menu.

F SPAN

Fine Span Adjustment (from *SETUP* prompt pressing the **F** key to advance)

1. With *FSPAN* displayed, place a calibrated test weight on the scale and press the **ENTER** key.
2. After pressing the **ENTER** key, the display will change to show the amount of the test weight and the annunciator display will alternately flash off and on (all ON, weighing unit off, then all OFF, weighing unit ON).
3. Press the **1/YES** to increase the span OR press the **0/NO** key to decrease the span.
4. Press the ***** key to return to the previous prompt or press the **ENTER** key to exit *FSPAN* and return to the *SETUP* menu.

Display High Resolution Weight

HI RES

High Resolution Weight

(This prompt can only be accessed from the *SETUP* prompt and requires pressing the F key to advance to it.)

1. With *HI RES* on the display, pressing the **ENTER** key will show the active weight in “high resolution” mode (in 1/10 interval).
2. Press the **PRINT** key to print the weight (followed by the text TEST) via the selected printer output port enabled during setup and calibration.
3. To exit the *HI RES* function, press the **F** key and then the ***** key to return to the weight display mode.

Key Lock Out Function

LOCCOUT

Key Lock Out Function

(This prompt can only be accessed from the *SETUP* prompt and requires pressing the F key to advance to it.)

The Key Lockout Feature allows keys on the indicator to be disabled for use by the operator “*during normal operation*”.

1. With *LOCCOUT* on the display, pressing *any* key will display “*LOCCD*” (locked) or “*UNLOCCD*” (unlocked) for the current key state.
2. Pressing a locked key during normal operation will result in a 1/2 second display “*LOCCD*” and the key will be ignored.
3. To exit the *LOCCOUT* function, press the **F** key.
4. The display will change to the *SETUP* menu prompt.
5. Press the ***** key to exit *SETUP* and return to the weight display mode.

Storing Indicator Defaults

1. Enter the Setup menu either by pressing the key sequence **F, 0, ***.
2. With *SETUP* displayed, press the **MEM** key.
3. The indicator will briefly display *SAVING* then return to the Setup menu.
4. At this time, all setup information not related to calibration will be stored as the default settings.

Restoring Indicator Defaults

1. Enter the Setup menu either by pressing the key sequence **F, 0, ***.
2. With *SETUP* displayed, press the **ZERO/CLEAR** key.
3. The indicator will display the prompt *DFLTSP?* (Restore Defaults?).
4. Press the **ENTER** key to show the current setting.
5. If the setting displayed is acceptable, press the **ENTER** key again to save it. Otherwise, using the numeric keys, **0/NO** or **1/YES**, enter the new setting and then press the **ENTER** key to save it.
6. If YES was selected, the indicator will display *LOADING* then return to the Setup Menu.
 - a. If the defaults have been previously saved as described in the previous section, these saved defaults will be restored (**RECALIBRATION IS NOT REQUIRED**).
 - b. If no defaults have been previously stored, the indicator will restore the new indicator defaults (**RECALIBRATION IS REQUIRED**).

2.3 INDICATOR SETUP REVIEW

The 212/212X indicator allows several operational parameters to be reviewed and changed without performing the full setup and configuration procedure.

Accessing Setup Review

1. With the indicator ON, press the * key.
2. The indicator will respond by showing the *FUNCTION=* (Function) prompt
3. Press the **F** key.
4. The display will change to show *LT= XX*. Note that XX is the current LCD Light Sensor Reading and is not adjustable.
5. Press the * key to return to the previous prompt.
6. To exit Setup Review, press the **ENTER** key to step through the remaining prompts OR at anytime, cycle the power (press the **ON/OFF** key twice).

LT= XXX Current LCD Light Sensor Reading (where XXX is the current value) **NOTE:** This value is not adjustable.

LSET= Light Sensor Reading at which LCD Backlight will turn ON
Note that the LCD Backlight will turn OFF at the *LSET=* value plus 10.

For example, if *LSET=* is 5, then the backlight will turn ON when the *LT=* reading is 5 and turn OFF when the *LT=* reading is 15.

If the setting displayed is acceptable, press the **ENTER** key again to save it. Otherwise, using the numeric keys, enter the new setting and then press the **ENTER** key to save it and advance to the next prompt. Allowable settings are 0 to 255.

NOTE: Use the same procedure as described in the Indicator Setup section of this manual to make any changes to the following:

TD= Time Format (12 or 24 hour)

D OUT= Digital Output Control Enable/Disable and Settings

The next prompt is only displayed when *D-OUT* = 1 or 11

P-BAL= Print On Balance

The following prompts are only displayed when *D-OUT* = 4 or 14

FIL-RA Fill Auto Accumulate

PURGE= Number of Digital Fill Cycles before purging feeder

P-WGT= Purge Weight – The amount of material contained in feeder before purge.

The next prompt is only displayed when *SPEED* = 2

GATE= Gate

The next prompts are only displayed when *D-OUT* = 4 or 14

A-TRIM Auto Trim

A-PRNT Auto Print

DFCEND DFC Ending Message *DONE* (if *SPEED*=2)

The next prompt will be displayed if *D-OUT* = 1, 2, 3, 11, 12 or 13

A-HLD= Auto-Hold

The following prompts are only displayed when *A-HLD* = 1 or 2

THRES= Threshold

A-ACC= Auto-Accumulate

BALTOL Balance Tolerance

DFLT= Digital Filtering

CONT1= Continuous Output Serial Port 1 Enable/Disable

TYPE= Continuous Output Format Selection

CONT2= Continuous Output Serial Port 2 Enable/Disable

TYPE= Continuous Output Format Selection

SLEEP= Sleep Mode Enable/Disable and Settings

A OFF= Auto-Shutdown Enable/Disable and Settings

A CLR= Auto Clear ID

2.4 INDICATOR OPERATIONAL SETUP REVIEW

This section describes another Setup Review that will only prompt for operational parameters (e.g., DFC parameters, digital filtering).

Accessing and Navigating the Operational Setup Review

1. With the indicator ON, press the **F** key followed by the **PRESET** key.
2. At each prompt, press the **ENTER** key to display the current value associated with that prompt.
3. To modify any current value, enter the desired value and then press the **ENTER** key.
4. Otherwise, press the **ENTER** key to keep the current value and advance to the next prompt.
5. To step past a group of parameters, press the **F** key.
6. To step backwards to a previous prompt, press the ***** key.
7. To exit this menu, press the **ENTER** key after the last prompt or press the ***** key at the first prompt.

Operational Setup Review Parameters

D-OUT= Digital Output Control Enable/Disable and Settings

The following prompts are only displayed when *D-OUT=* 4 or 14

FMODE= DFC mode of operation

FIL-RR Fill Auto Accumulate

PURGE= Number of Digital Fill Cycles before purging feeder

P-WGT= Purge Weight – The amount of material contained in feeder before purge.

The next prompt is only displayed when *D-OUT=* 1 or 11

P-BAL= Print On Balance

The next prompt is only displayed when *DOUT=* 4 or 14 and *FMODE=* 0

SPEED= Single or Dual speed DFC operation

The next prompt is only displayed when *SPEED= 2* and *FMODE= 0*

GATE= 2 Speed gate sequence

The following prompts are only displayed if *DOUT= 4* or *14* and *FMODE > 0*

CHATR= Time in seconds that output is active while chattering

CHTOFF Time in seconds that output is inactive while chattering

CHTRWT Weight of material to be distributed in by the chatter gate feature

TRMWT Trim weight

The next prompt will only displayed if *DOUT= 4* or *14* and *FMODE > 0*

A-TRIM Auto Trim

The next prompts are only displayed when *D-OUT = 4* or *14*

A-PRNT Auto Print

DFCEND DFC Ending Message *DONE* (if *SPEED=2*)

The next prompt will be displayed if *D-OUT = 1, 2, 3, 11, 12* or *13*

A-HLD= Auto-Hold

The following prompts are only displayed when *A-HLD = 1* or *2*

THRES= Threshold

A-RCC= Auto-Accumulate

BALTOL Balance Tolerance

A CLR= Auto Clear ID

DFLT= Digital Filtering

3. OPERATION

3.1 Standard Weighing

Recommended Settings:

O *OUT*=0

A-HLD=0

Weighing Procedure (Gross Weight):

1. With the scale empty, verify the scale is showing 0 units (lb, kg, etc) Gross (the Gross annunciator will be shown). If not in Gross mode (the Net annunciator instead is shown), press the **NET/GROSS** key to switch to Gross mode.
2. If the scale is showing a weight different than 0, press the **ZERO/CLEAR** key to zero the scale.
3. The scale is now ready to receive weight. Add material to be weighed and remove when finished.
4. Repeat these steps for subsequent weights.

Weighing Procedure (Net Weight):

1. With the scale empty, verify the scale is showing 0 units Gross. If not in Gross mode, press the **0** key then the **TARE** key to clear the stored tare weight and the indicator will display Gross weight.
2. If the scale is showing a weight different than 0, press the **ZERO/CLEAR** key to zero the scale.
3. Place a tare weight on the scale (ex: an empty container) then press the **TARE** key; or if you know the tare weight, you can manually enter it by keying in the value followed by the **TARE** key (ex: if you want to tare 50lbs, key in the sequence: **5, 0, TARE**).
4. The scale is now ready to receive weight. You can place a filled container on the scale or if you prefer, you can place an empty container on the scale and watch the weight as you fill it.
5. Repeat these steps for subsequent weights. If you wish to continue using the same stored tare weight, skip step 1.

3.2 Subtractive Weighing

Recommended Settings:

O *OUT*=0

A-HLD=0

Weighing Procedure:

1. Verify the scale is in Load mode (the Unload annunciator will be turned off). You can toggle back and forth between Load and Unload mode by pressing the **LOAD/UNLOAD** key.
2. With the scale empty, verify the scale is showing 0 units Gross. If not in Gross mode, press the **0** key then the **TARE** key to clear the stored tare weight and the indicator will display Gross weight.
3. If the scale is showing a weight different than 0, press the **ZERO/CLEAR** key to zero the scale.
4. The scale is now ready to be loaded. Add material until desired weight is reached.
5. Press the **LOAD/UNLOAD** key. The loaded weight will be stored as the tare weight. The indicator will display 0 units Net and switch to Unload mode.
6. The scale is now ready to be Unloaded. Any weight removed from the scale will be displayed as a *positive* weight. Any weight added to the scale will be displayed as a *negative* weight. Remove material until a desired weight is Unloaded.
7. If you wish to Unload a new weight without adding material to the scale, simply press the **TARE** key or the **ZERO/CLEAR** key to zero the scale and repeat steps 6 and 7 as desired.
8. To return to Load mode (and to display the amount of material remaining on the scale), press the **LOAD/UNLOAD** key. **NOTE:** Your Unloaded weight will be lost

3.3 Auto-Hold for Animal Weighing

Recommended Settings:

O **OUT=0**

A-HLD=1 (Standard mode) *or 2* (Advanced Mode)

THRES= This value should be about 50% to 75% of the average animal's weight. Modify this value as needed by pressing the **PRESET** key described below.

A-ACC= **YES** (if you want each Auto-Hold weight to be added to an accumulator)

BALTDL This value should be reasonably small since this is the amount of weight fluctuation allowed for the Auto-Hold to still actuate.

Auto-Hold Preset Setup Procedure:

- Verify your preset threshold value is correct by pressing the **PRESET** key.
- The indicator will display the prompt *THRES=*. Press the **ENTER** key to display the current value.
- If this value is correct, press the **ENTER** key otherwise key in your desired threshold weight value and press **ENTER**.

Weighing Procedure:

1. With the scale empty, verify the scale is showing 0 units Gross. If not in Gross mode, press the **0** key then the **TARE** key to clear the stored tare weight and the indicator will display Gross weight.
2. If the scale is showing a weight different than 0, press the **ZERO/CLEAR** key to zero the scale.
3. If you wish to use a tare weight, place a tare weight on the scale then press the **TARE** key; Or if you know the tare weight, you can manually enter it by keying in the value followed by the **TARE** key.
4. The scale is now ready to weigh an animal. Direct the animal onto the scale.
5. Once the scale becomes stable above the preset threshold (*THRES*) value, a 3 second timer will start. If the weight stays within the balance tolerance (+ or – *BALTDL*), the indicator will lock onto the average weight once the timer expires. If the weight variation is greater than the balance tolerance, the timer will stop and the indicator will wait for the scale to become stable above the threshold weight once again. The 3 second timer will restart once stable. This process will repeat until a hold weight is acquired.

6. The weighing is now complete and the animal can be removed from the scale.
7. If you are using Standard Mode ($R-HLD= 1$) the held weight will be released once the scale weight drops below the preset threshold.
8. If you are using Advanced Mode ($R-HLD= 2$), the held weight will not be released. Instead, the weight will continue to hold on the indicator until a new hold weight is acquired (i.e. another animal is weighed).
9. Repeat these steps for subsequent animal weights. If you wish to continue using the stored tare weight, skip steps 1-3.

3.4 Preset Weight Comparator (PWC)

This feature is useful to determine if an item is above a specified target weight.

Recommended Settings:

D OUT= 1, 2, or 3

(for 1, 2, or 3 preset weights) **or 11, 12, or 13** (for inverted outputs)

P-BAL = **YES** (if using a printer, Print On Balance is available for *DDOUT* = 1)

A-HLD= **0** (Unless the weight to be compared is an animal weight)

PWC Preset Setup Procedure:

1. Verify your desired PWC weight(s) are correct by pressing the **PRESET** key.
2. If *A-HLD*= above is set to 1 or 2, the first prompt you see will be *THRES*= . This is the threshold weight for the Auto-Hold feature. Press the **ENTER** key to display the current value. If the value is correct, press the **ENTER** key otherwise key in your desired threshold weight and press the **ENTER** key.
3. The display will show the prompt *PWC1*= . This is the value of the first preset weight to be compared. Press the **ENTER** key to display the current value. If this value is correct, press the **ENTER** key to accept otherwise key in your desired preset weight value and press **ENTER**. If *DDOUT*= 1 was selected, you are finished with Presets.
4. The display will now show *PWC2*= . This is the value of the second preset weight to be compared. Press the **ENTER** key to display the current value. If this value is correct, press the **ENTER** key to accept otherwise key in your desired preset weight value and press **ENTER**. If *DDOUT*= 2 was selected, you are finished with Presets.
5. The display will now show *PWC3*= . This is the value of the third preset weight to be compared. Press the **ENTER** key to display the current value. If this value is correct, press the **ENTER** key to accept otherwise key in your desired preset weight value and press **ENTER**.

PWC Weighing Procedure

1. With the scale empty, verify the scale is showing 0 units Gross. If not in Gross mode, press the **0** key then the **TARE** key to clear the stored tare weight and the indicator will display Gross weight.
2. If the scale is showing a weight different than 0, press the **ZERO/CLEAR** key to zero the scale.
3. If you wish to use a tare weight, place a tare weight on the scale then press the **TARE** key; Or if you know the tare weight, you can manually enter it by keying in the value followed by the **TARE** key.
4. Place a material to be weighed on the scale. If weight exceeds any of the Preset weight values, the associated display annunciators will turn on along with the respective PWC outputs. (Ex: if presets PWC1 = 1000, PWC2 = 2000 and the weight placed on the scale is 1500, PWC1 would be on and PWC2 would not).
5. You can add material as desired until the required target preset value is reached.
6. Repeat these steps for subsequent PWC iterations. If you wish to continue using the stored tare weight, skip steps 1 to 3.

3.5 Digital Fill Control (DFC)

Specified Target Weight DFC

This feature is useful to determine if an item is above a specified target weight.

Recommended Settings:

D OUT= 4 (Required) **or 14** (Required for inverted outputs)

FIL-AA= YES for each completed fill weight to be added to an accumulator

PURGE= N Where N the number of fill cycles you require before a manual feeder purge will take place. Set to 0 to disable

P-WGT= This is the weight of material contained within the feeder you will be purging.

SPEED= 1 (discharge motor only has 1 speed) **or 2** (discharge motor is 2 speed)

GATE= This is the motor control or gate sequence if using 2 speed operation. Refer to the setup portion of the manual for details on this setting)

A-TRIM= YES Automatically adjust trim weight for more accurate fill

A-PRNT= YES If using a printer, this will automatically print at the end of a fill cycle

DFC Preset Setup Procedure (Load & Unload Mode):

1. Verify your desired fill and trim weights are stored in the indicator by pressing the **PRESET** key. If **SPEED= 2** was selected above, skip to step 3.
2. The display will read **FILL= .** This is the desired fill weight. Press the **ENTER** key to display the current value. If this value is correct, press the **ENTER** key to accept otherwise key in your desired fill weight then press **ENTER**. Skip to step 5.
3. The display will read **FAST= .** This is the weight at which the indicator will switch from fast to slow fill. Press **ENTER** to display the current value. If this value is acceptable, press **ENTER** to accept otherwise key in your desired fast fill then press **ENTER**.
4. Next you will be prompted **SLOW= .** This is the desired final fill weight. Press **ENTER** to display the current value. If this value is acceptable, press **ENTER** otherwise key in your desired fill weight then press **ENTER**.

5. Next you will be prompted *TRIM=* . This is the amount of material in the air free-falling when the DFC ends. So the actual DFC cutoff will be *FILL - TRIM*. Press **ENTER** to display the current value. If the current value is acceptable, press the **ENTER** key to accept otherwise key in your desired trim value and press **ENTER**.

NOTE: If *A-TRIM* above is set to YES, the trim value will be adjusted accordingly at the end of each cycle.

DFC Weighing Procedure (Load Mode):

1. Verify the scale is in Load mode (the Unload annunciator will be turned off). You can toggle back and forth between Load and Unload mode by pressing the **LOAD/UNLOAD** key.
2. With the scale empty, verify the scale is showing 0 units Gross. If not in Gross mode, press the **0** key then the **TARE** key to clear the stored tare weight and the indicator will display Gross weight.
3. If the scale is showing a weight different than 0, press the **ZERO/CLEAR** key to zero the scale.
4. If you wish to use a tare weight, place a tare weight on the scale then press the **TARE** key; Or if you know the tare weight, you can manually enter it by keying in the value followed by the **TARE** key.
5. The scale is now ready to be Loaded using the DFC. Press the **F** key followed by the **ID/START** key to start the cycle.
6. The fill will start and proceed according to the *SPEED* and *GATE* settings you selected.
7. If at any time, you wish to pause the fill cycle, press the **HOLD** key. The indicator will display *PAUSED*. To restart/continue the filling operation, press the **HOLD** key again to “unpause.” Or to abort the fill, press the ***** key.
8. The fill cycle will end once the preset fill weight is reached.
9. Remove the material from the scale. Repeat these steps for subsequent fill cycles. If you wish to continue using the stored tare weight, skip steps 1 to 4.
10. If you have a value set for *PURGE* above, the indicator will be counting the number of fill cycles completed and once the purge count (*PURGE* value) is reached, the purge weight (*P-WGT*) will be added to the trim weight and flash *PURGE FEEDER* on the display. At this time, you would need to manually purge your feeder onto the scale.

DFC Weighing Procedure (Unload Mode):

1. Verify the scale is in Load mode (the Unload annunciator will be turned off). You can toggle back and forth between Load and Unload mode by pressing the **LOAD/UNLOAD** key.
2. With the scale empty, verify the scale is showing 0 units Gross. If not in Gross mode, press the **0** key then the **TARE** key to clear the stored tare weight and the indicator will display Gross weight.
3. Now Load the scale with the amount of material you wish to distribute (this should be greater than or equal to your preset fill weight).
4. Press the **LOAD/UNLOAD** key. The scale will store the filled weight as the tare weight, switch to Unload mode, and display 0 units Net weight.
5. The scale is now ready to be Unloaded using the DFC. Position the feeder over the container to be filled and start the fill by press the **F** key followed by the **ID/START** key.
6. The fill will start and proceed according to the *SPEED* and *GATE* settings you selected.
7. If at any time, you wish to pause the fill cycle, press the **HOLD** key. The indicator will display *PAUSED*. To restart/continue the filling operation, press the **HOLD** key again to “unpause.” Or to abort the fill, press the ***** key.
8. The fill cycle will end once the preset fill weight is removed from the scale. If *DFCEND=YES* was selected, the indicator will display *DONE* until a key is pressed.
9. If there is enough material remaining on the scale, position the feeder above your next container to fill and press the **F** key then the **ID/START** key to start the next fill cycle. (If the *DONE* message is still displayed, simply press the **ID/START** key to start the next fill). If there is not enough material on the scale when these keys are pressed, the indicator will display *ERROR*. Repeat this step for subsequent fill cycles.

10. If you wish to check how much material is remaining on the scale, switch to Load mode by pressing the **LOAD/UNLOAD** key.

NOTE: The displayed Unload weight will be lost when you do this and cannot be done in the middle of a fill cycle. Press the **LOAD/UNLOAD** key again to switch back to Unload mode before starting the next cycle.

11. If you have a value set for *PURGE* above, the indicator will be counting the number of fill cycles completed and once the purge count (*PURGE* value) is reached, the purge weight (*P-WGT*) will be added to the trim weight and flash *PURGE FEEDER* on the display. At this time, you would need to manually purge your feeder into the last container.

Simple DFC (Simple-Fill)

In this mode, the 100 memory ID locations are unavailable. The **MEM** and **RECALL** keys will have no functionality. This mode also will default to a 2-speed, chatter gate operation (non-selectable) with no auto-trim. This mode is useful when ID storage and weight accumulations are not needed, but the ability to quickly change target fill weight is required.

Recommended Settings:

D OUT= 4 (Required) **or 14** (Required for inverted outputs)

FMODE=1 (Required for Simple-Fill)

FIL-AA= YES for each completed fill weight to be added to an accumulator

PURGE= N Where N the number of fill cycles you require before a manual feeder purge will take place. Set to 0 to disable

P-WGT= This is the weight of material contained within the feeder you will be purging.

SPEED= 1 (discharge motor only has 1 speed) **or 2** (discharge motor is 2 speed)

CHATR= This is the amount of time (in seconds) the output will be active when chattering.

CHTOFF This is the amount of time (in seconds) the output will be inactive when chattering.

TRMWT= This is the trim weight. Target weight – trim weight = weight at which chattering will begin.

A-PRNT= YES If using a printer, this will automatically print at the end of a fill cycle

DFCEND YES If you want the indicator to display *DONE* upon completion of a fill cycle.

DFC Preset Setup Procedure (Load & Unload Mode):

1. Verify your desired fill weight is stored in the indicator by pressing the **PRESET** key.
2. The display will read *FILL= .* This is the target fill weight. Press the **ENTER** key to display the current value. If this value is correct, press the **ENTER** key to accept otherwise key in your desired fill weight then press **ENTER**.

DFC Weighing Procedure (Load Mode):

1. Verify the scale is in Load mode (the Unload annunciator will be turned off). You can toggle back and forth between Load and Unload mode by pressing the **LOAD/UNLOAD** key.
2. With the scale empty, verify the scale is showing 0 units Gross. If not in Gross mode, press the **0** key then the **TARE** key to clear the stored tare weight and the indicator will display Gross weight.
3. If the scale is showing a weight different than 0, press the **ZERO/CLEAR** key to zero the scale.
4. If you wish to use a tare weight, place a tare weight on the scale then press the **TARE** key; Or if you know the tare weight, you can manually enter it by keying in the value followed by the **TARE** key.
5. The scale is now ready to be Loaded using the DFC. Press the **ID/START** key to start the cycle.
6. If at any time, you wish to pause the fill cycle, press the **HOLD** key. The indicator will display **PAUSED**. To restart/continue the filling operation, press the **HOLD** key again to “unpause.” Or to abort the fill, press the * key.
7. Chattering will begin once the chatter weight is reached (fill weight – trim weight). When chattering, the DFC output will pulse on and off. The settings for these pulse durations are described in the Recommended Settings section above.
8. The fill cycle will end once the preset fill weight is reached. (**)
If **DFCEND=YES** was selected, the indicator will display “*DONE*” until a key is pressed.
9. Remove the material from the scale. Repeat these steps for subsequent fill cycles. If you wish to continue using the stored tare weight, skip steps 1 to 4.
10. If you have a value set for **PURGE** above, the indicator will be counting the number of fill cycles completed and once the purge count (**PURGE** value) is reached, the purge weight (**P-WGT**) will be added to the trim weight and flash **PURGE FEEDER** on the display. At this time, you would

DFC Weighing Procedure (Unload Mode):

1. Verify the scale is in Load mode (the Unload annunciator will be turned off). You can toggle back and forth between Load and Unload mode by pressing the **LOAD/UNLOAD** key.
2. With the scale empty, verify the scale is showing 0 units Gross. If not in Gross mode, press the **0** key then the **TARE** key to clear the stored tare weight and the indicator will display Gross weight.
3. Now Load the scale with the amount of material you wish to distribute (this should be greater than or equal to your preset fill weight). If you wish to key in a known Net weight of the material you just loaded, go to the next step. Otherwise, go to step 5.
4. To set the indicator's Net weight, press the **F** key followed by the **NET/GROSS** key. The indicator will display *NETWT=*. Press **ENTER** to display the current Net weight value. Key in your known Net weight, then press **ENTER**. The indicator will now display the live Net weight with your keyed in weight value.
5. Press the **LOAD/UNLOAD** key. The scale will store the Net weight as the tare weight, switch to Unload mode, and display 0 units Net weight.
6. The scale is now ready to be Unloaded using the DFC. Position the feeder over the container to be filled and start the fill by press the **F** key followed by the **ID/START** key.
7. If at any time, you wish to pause the fill cycle, press the **HOLD** key. The indicator will display *PAUSED*. To restart/continue the filling operation, press the **HOLD** key again to "unpause." Or to abort the fill, press the ***** key.
8. Chattering will begin once the chatter weight is reached (fill weight – trim weight). When chattering, the DFC output will pulse on and off. The settings for these pulse durations are described in the Recommended Settings section above.
9. The fill cycle will end once the preset fill weight is removed from the scale. If *DFCEND=YES* was selected, the indicator will display *DONE* until a key is pressed.
10. If there is enough material remaining on the scale, position the feeder above your next container to fill and press the **F** key then the **ID/START** key to start the next fill cycle. (If the *DONE* message is still displayed, simply press the **ID/START** key to start the next fill). If there is not enough material on the scale when these keys are pressed, the indicator will display *ERROR*. Repeat this step for subsequent fill cycles.

11. If you wish to check how much material is remaining on the scale, switch to Load mode by pressing the **LOAD/UNLOAD** key.

NOTE: The displayed Unload weight will be lost when you do this and cannot be done in the middle of a fill cycle. Press the **LOAD/UNLOAD** key again to switch back to Unload mode before starting the next cycle.

12. If you have a value set for *PURGE* above, the indicator will be counting the number of fill cycles completed and once the purge count (*PURGE* value) is reached, the purge weight (*P-WGT*) will be added to the trim weight and flash *PURGE FEEDER* on the display. At this time, you would need to manually purge your feeder into the last container.

Box-Tracker DFC Mode (Box Fill)

In this mode, the 100 memory ID locations are used to keep track of a material's remaining Net weight. Each memory location also will contain a target fill weight, a weight accumulator, and a fill counter. The indicator will prompt for all of these values when storing/editing a memory ID file. Refer to section 3.6 for instruction on storing/editing memory. This mode also will default to a 2-speed, chatter gate operation (non-selectable) with no auto-trim.

Recommended Settings:

D OUT= 4 (Required) **or 14** (Required for inverted outputs)

FMODE=2 (Required for Box Fill)

FIL-AA= YES for each completed fill weight to be added to an accumulator

PURGE= N Where N the number of fill cycles you require before a manual feeder purge will take place. Set to 0 to disable

P-WGT= This is the weight of material contained within the feeder you will be purging.

CHATR= This is the amount of time (in seconds) the output will be active when chattering.

CHTOFF This is the amount of time (in seconds) the output will be inactive when chattering.

TRMWT= This is the trim weight. Target weight – trim weight = weight at which chattering will begin.

A-PRNT= YES If using a printer, this will automatically print at the end of a fill cycle

DFCEND YES If you want the indicator to display *DONE* upon completion of a fill cycle.

DFC Preset Setup Procedure (Unload Mode Only):

1. Verify your desired fill weight is stored in the indicator by pressing the **PRESET** key.
2. The display will read *FILL=*. This is the target fill weight. Press the **ENTER** key to display the current value. If this value is correct, press the **ENTER** key to accept otherwise key in your desired fill weight then press **ENTER**.
3. Repeat these steps after loading a memory ID as the indicator will load the memory ID's target weight whenever an ID is selected.

DFC Weighing Procedure (Unload Mode Only):

1. Verify the scale is in Load mode (the Unload annunciator will be turned off). You can toggle back and forth between Load and Unload mode by pressing the **LOAD/UNLOAD** key.
2. With the scale empty, verify the scale is showing 0 units Gross. If not in Gross mode, press the **0** key then the **TARE** key to clear the stored tare weight and the indicator will display Gross weight.
3. Now Load the scale with the material you wish to distribute.
4. Load the memory ID associated with the material you just loaded onto the scale by repeatedly pressing the **RECALL** key until the correct material ID is displayed, then press the **ENTER** key. The indicator will set and display the Net weight stored for the selected memory ID.
5. Press the **LOAD/UNLOAD** key. The scale will store the Net weight as the tare weight, switch to Unload mode, and display 0 units Net weight.
6. The scale is now ready to be Unloaded using the DFC. Position the feeder over the container to be filled and start the fill by press the **F** key followed by the **ID/START** key.
7. If at any time, you wish to pause the fill cycle, press the **HOLD** key. The indicator will display *PAUSED*. To restart/continue the filling operation, press the **HOLD** key again to “unpause.” Or to abort the fill, press the ***** key.
8. Chattering will begin once the chatter weight is reached (fill weight – trim weight). When chattering, the DFC output will pulse on and off. The settings for these pulse durations are described in the Recommended Settings section above.
9. The fill cycle will end once the preset fill weight is removed from the scale. If *DFCEND=YES* was selected, the indicator will display *DONE* until a key is pressed.
10. If there is enough material remaining on the scale, position the feeder above your next container to fill and press the **F** key and then the **ID/START** key to start the next fill cycle (if the *DONE* message is still displayed, simply press the **ID/START** key to start the next fill). If there is not enough material on the scale when these keys are pressed, the indicator will display **ERROR**. Repeat this step for subsequent fill cycles.

11. If you wish to check how much material is remaining on the scale, switch to Load mode by pressing the **LOAD/UNLOAD** key.

NOTE: The displayed Unload weight will be lost when you do this and cannot be done in the middle of a fill cycle. Press the **LOAD/UNLOAD** key again to switch back to Unload mode before starting the next cycle.

12. If you have a value set for *PURGE* above, the indicator will be counting the number of fill cycles completed and once the purge count (*PURGE* value) is reached, the purge weight (*P-WGT*) will be added to the trim weight and flash *PURGE FEEDER* on the display. At this time, you would need to manually purge your feeder into the last container.

Plot-Tracker DFC Mode (Plot Fill)

This DFC mode expands on the Box-Tracker DFC mode. In this mode, the 10 of the 100 memory ID locations are used to keep track of a material's remaining Net weight (Box Tracker). The remaining 90 memory ID locations are used to keep track of how much material is delivered to a specific plot (Plot Tracker). This mode also will default to a 2-speed, chatter gate operation (non-selectable) with no auto-trim.

Recommended Settings:

D OUT= 4 (Required for DFC)

OR

D OUT= 14 (Required for DFC with inverted outputs)

FMODE= 3 (Required for Plot Fill)

FIL-AA= YES for each completed fill weight to be added to an accumulator

PURGE= N Where N the number of fill cycles you require before a manual feeder purge will take place. Set to 0 to disable

P-WGT= This is the weight of material contained within the feeder you will be purging.

CHATR= This is the amount of time (in seconds) the output will be active when chattering.

CHTOFF This is the amount of time (in seconds) the output will be inactive when chattering.

TRMUT= This is the trim weight. Target weight – trim weight = weight at which chattering will begin.

A-PRNT= YES If using a printer, this will automatically print at the end of a fill cycle

DFCEND YES If you want the indicator to display *DONE* upon completion of a fill cycle.

Storing/Reviewing/Selecting/Editing Memory Locations in Plot-Tracker DFC Mode:

This section describes the memory operations of the Plot-Tracker DFC mode. This mode must be selected prior to performing any of the following operations. To select, refer to the recommended settings above. Refer to section 3.6 for additional instruction on reviewing/editing memory.

Storing a Box ID:

1. Press the **MEM** key. The indicator will prompt *ID=*.
2. Use the alphanumeric keys to name the box ID you are creating and then press the **ENTER** key.
3. Next the indicator will prompt *FILWT=*. Press **ENTER** to display the fill weight value associated with this ID and then enter your desired target fill weight for this box ID and press the **ENTER** key (a non-zero value is required).
4. The indicator will then prompt for the net weight of the box ("*NETWT=*"). Press **ENTER** to display the current value, then key in net weight of your box and press **ENTER**.
5. The indicator will then prompt for the starting weight accumulation ("*ACCUM=*") and fill counter ("*COUNT=*"). You can set these values just like steps 3 and 4 or simply press **ENTER** to store the default value of 0 for each. After storing the fill counter value, the indicator will return to the weight display (you can tell this whenever the **MEM** display annunciator turns off).

Storing a Plot ID:

1. Press the **MEM** key. The indicator will prompt *ID=*.
2. Use the alphanumeric keys to name the box ID you are creating and then press the **ENTER** key.
3. Next the indicator will prompt *FILWT=*. Press **ENTER** to display the default fill weight value of 0. Verify the displayed value is equal to 0 and then press **ENTER**. If the displayed value is not zero, press the **0** key and then press **ENTER**.
4. The indicator will then prompt for the starting weight accumulation *ACCUM=*. Press **ENTER** to display the default starting value. If you wish to modify the starting accumulation, enter your desired starting value and then press **ENTER**.

5. The indicator will then prompt for the starting DFC counter *COUNT=*. Press **ENTER** to display the default starting value. If you wish to modify the starting count value enter your desired starting value then press **ENTER**. After storing the fill counter value, the indicator will return to the weight display (you can tell this whenever the MEM display annunciator turns off).

Reviewing Memory using the **RECALL** key:

1. From the weight display, press the **RECALL** key. You are now in the ID Review menu. You will see the first Box ID displayed. Notice which display annunciators are visible.
 - a. The MEM annunciator signifies the displayed information is being read from memory.
 - b. The ID annunciator signifies the displayed information is an ID name.
 - c. The 1 annunciator signifies that the displayed ID is from list 1 (Box ID List)
2. Pressing the **NET/GROSS** key will display the remaining net weight stored with the previously displayed ID (This feature is also available for in the Box-Tracker DFC mode). Notice now which display annunciators are active.
 - a. The MEM annunciator signifies the displayed information is being read from memory.
 - b. The 1 annunciator signifies that the displayed information is from ID list 1.
 - c. The UNITS (lb or kg) annunciators the unit of the displayed weight.
 - d. The NET annunciator signifies the displayed value is a net weight.

3. Pressing the **MEM** key will display the weight accumulator associated with the previously displayed ID. Notice now which display annunciators are active.
 - a. The MEM annunciator signifies the displayed information is being read from memory.
 - b. The ACCUM annunciator signifies the displayed information is a weight accumulation.
 - c. The 1 annunciator signifies the displayed information is from ID list 1.
4. Pressing the **F** key will toggle between ID lists. Notice which display annunciators are active
 - a. The MEM annunciator signifies the displayed information is being read from memory.
 - b. The ID annunciator signifies the displayed information is an ID name.
 - c. The 2 annunciator signifies the displayed ID is from list 2 (Plot ID List).
5. Pressing the **RECALL** key will advance to the next ID in the currently displayed list.
6. Pressing the ***** key will exit the review menu and return to the weight display.

Selecting a Stored Box ID using the RECALL key:

1. Make sure the indicator is displaying weight in LOAD mode. If the indicator is not in LOAD mode, press the **LOAD/UNLOAD** key to toggle LOAD mode.
2. From the weight display, press the **RECALL** key repeatedly until your desired box ID is displayed and then press **ENTER** to select it.
3. The indicator will display the box ID's target weight for 3 seconds and then display the net weight remaining in the box ID you selected.

Selecting a Stored Plot ID using the RECALL key:

1. Verify the scale is in Load mode (the Unload annunciator will be turned off). You can toggle back and forth between Load and Unload mode by pressing the **LOAD/UNLOAD** key.
2. Press the **RECALL** key. The first box ID will be displayed.
3. Press the **F** key to toggle the ID type. The first plot ID is now displayed (pressing the **F** key again will toggle back to displaying box IDs).
4. Press the **RECALL** key repeatedly until your desired plot ID is displayed, then press **ENTER** to select it.

Selecting Box and Plot ID's using the ID key:

1. Verify the scale is in Load mode (the Unload annunciator will be turned off). You can toggle back and forth between Load and Unload mode by pressing the **LOAD/UNLOAD** key.
2. Press the **ID/START** key. The indicator will prompt *BOX=*. Use the alpha-numeric keys to key in your desired box ID then press **ENTER**.
3. The indicator will prompt *PLOT=*. Use the alpha-numeric keys to key in your desired plot ID then press **ENTER**.
4. The indicator will display the box ID's target weight for 3 seconds, then display the net weight remaining in the box ID you selected.

Recalling a Stored Box ID for Editing:

1. Press the **MEM** key followed by the **RECALL** key. The first box ID is displayed.
2. Continue pressing the **RECALL** key until your desired box ID is displayed, then press **ENTER**.
3. Follow steps 3-5 from the section "Storing a Box ID" above to edit the stored ID values.

Recalling a Stored Plot ID for Editing:

1. Press the **MEM** key followed by the **RECALL** key. The first box ID is displayed.
2. Press the **F** key to toggle the ID type. The first plot ID is displayed.
3. Continue pressing the **RECALL** key until your desired plot ID is displayed, then press **ENTER**.
4. Follow steps 4-5 from the section “Storing a Plot ID” above to edit the stored ID values.

Editing a Stored ID by Keying the ID:

1. Press the **MEM** key. The indicator will prompt *ID=*.
2. Use the alpha-numeric keys to key in the box ID or plot ID that you wish to edit, then press **ENTER**.
3. Edit the stored values by following:
 - a. Steps 3-5 from the section “Storing a Box ID” if you keyed in a box ID.
 - b. Steps 4-5 from the section “Storing a Plot ID” if you keyed in a plot ID.

DFC Preset Setup Procedure (Unload Mode Only):

1. A box ID and a plot ID must be selected prior to starting a fill operation. Follow one of the procedures from the previous section **Storing/Reviewing/Selecting/Editing Memory Locations in Plot-Tracker DFC Mode** to select the 2 ID's you wish to use.
2. Verify your desired fill weight is stored in the indicator by pressing the **PRESET** key.
3. The display will read *FILL=*. This is the target fill weight. Press the **ENTER** key to display the current value. If this value is correct, press the **ENTER** key to accept otherwise key in your desired fill weight then press **ENTER**.

DFC Weighing Procedure (Unload Mode Only):

1. With the box ID and plot ID selected, press the **LOAD/UNLOAD** key. The scale will store the Net weight as the tare weight, switch to Unload mode, and display 0 units Net weight.
2. The scale is now ready to be Unloaded using the DFC. Position the feeder over the container to be filled and start the fill by pressing the **F** key followed by the **ID/START** key.
3. If at any time, you wish to pause the fill cycle, press the **HOLD** key. The indicator will display *PAUSED*. To restart/continue the filling operation, press the **HOLD** key again to “un-pause.” Or to abort the fill, press the ***** key.
4. Chattering will begin once the chatter weight is reached (fill weight – trim weight). When chattering, the DFC output will pulse on and off. The settings for these pulse durations are described in the Recommended Settings section above.
5. The fill cycle will end once the preset fill weight is removed from the scale. If *DFCEND=YES* was selected, the indicator will display *DONE* until a key is pressed.
6. If there is enough material remaining on the scale, position the feeder above your next container to fill and press the **F** key then the **ID/START** key to start the next fill cycle (if the *DONE* message is still displayed, simply press the **ID/START** key to start the next fill). If there is not enough material on the scale when these keys are pressed, the indicator will display *ERROR*. Repeat this step for subsequent fill cycles.
7. If you wish to check how much material is remaining on the scale, switch to the Load mode by pressing the **LOAD/UNLOAD** key.
NOTE: The displayed Unload weight will be lost when you do this and cannot be done in the middle of a fill cycle. Press the **LOAD/UNLOAD** key again to switch back to Unload mode before starting the next cycle.
8. If you have a value set for *PURGE* above, the indicator will be counting the number of fill cycles completed and once the purge count (*PURGE* value) is reached, the purge weight (*P-WGT*) will be added to the trim weight and flash *PURGE FEEDER* on the display. At this time, you would need to manually purge your feeder into the last container.

3.6 Using Memory/ID Storage

The 212/212x indicator can store up to 100 ID's in memory. Stored with each ID is a weight accumulator, a weight counter, the last weighing, a threshold preset weight used for animal weighing, and two weight presets used for DFC and PWC operations.

Recommended Settings:

Setup your indicator for the desired operation mode before creating ID's because when you create an ID, you will only be prompted for presets relevant to the current mode or features selected.

(Ex: If you have *DDUT*= 0 and *A-HLD*= 1 set, you will only be prompted to store the preset threshold weight (*THRES*) used with the Auto-Hold feature. You will not be prompted to store any preset values for the *DDUT* settings).

Adding an ID to Memory:

1. While the indicator is displaying weight, press the **MEM** key.
2. The indicator will display *ID*= . Now you can enter in your desired 6-digit alpha-numeric ID. To use letters, you must press a key in rapid succession until the desired letter is displayed. This is similar to the way a cell phone keypad operates. (Ex: If you want to enter the letter C, you would need to press the **2** key four times).
3. If you make a mistake, you can press the **ZERO/CLEAR** key to back up 1 character.
4. Press **ENTER** key to store the ID.
5. You will be prompted to store values associated with this ID starting with Presets for the feature(s) you have selected. These prompts are the same as described in the "Preset Setup Procedure" subsections of the Auto-Hold, PWC, and DFC sections above.
6. With each prompt, press the **ENTER** key to display the current value. If the value is acceptable, press **ENTER** to accept otherwise key in your desired value then press **ENTER**.
7. Once you have entered all of the presets for the ID, the display will show *ACCUM*= . This is the starting value of the accumulated weight associated with the ID. Press **ENTER** to display the current value (default is 0). If this value is acceptable, press the **ENTER**, otherwise enter in a starting value for the accumulator and press **ENTER**.

8. The next prompt you will see is *COUNT=*. This is the starting value for the weight counter associated with the ID you are creating. Press the **ENTER** key to display the starting value (0 is default). If this value is acceptable, press the **ENTER** key, otherwise enter in a starting value for the weight counter and press the **ENTER** key.
9. You will now be returned to weight display. Repeat these steps for each ID you wish to store.

Editing a Stored ID:

1. Follow the procedure described above in the section “*Adding an ID to Memory*” except when the display shows *ID=*, key in the stored ID that you would like to modify then press the **ENTER** key.

Reviewing Stored IDs and Accumulators:

1. While the indicator is displaying weight, press the **RECALL** key. The indicator will enter an “ID Review” mode and will display the first stored ID from memory. **NOTE:** The first displayed ID is not necessarily the first ID stored. The ID's will be recalled in numerical/alphabetical order.
2. If you wish to view the current accumulated value associated with the ID displayed, press the **MEM** key. You can toggle back to displaying the ID by pressing the **MEM** key again.
3. To view the next ID stored, press the **RECALL** key. Repeat steps 2 and 3 to review the rest of the ID's stored.
4. Press the * key to exit “ID Review” mode and return to the displaying weight.

Selecting an ID to Use:

An ID can be selected 2 different ways:

1. Follow the procedure described above under the section “*Reviewing Stored IDs and Accumulators*” until the ID you wish to use is displayed then press the **ENTER** key. That ID is now selected.
2. Or Press the **ID/START** key from the weight display. *ID=* will be shown. Enter the ID you wish to use then press the **ENTER** key. If the ID exists, it will be selected.

Deselecting a Selected ID:

1. While displaying weight and if an ID is selected, you can deselect it by pressing the * key. The ID and MEM display annunciators will blink twice alternating one at a time to signify that the current ID has been deselected.

Using Memory IDs to Accumulate Weight:

1. With an ID selected, press the **PRINT/ACCUM** key. The current weight displayed will be added to the selected ID's accumulator and the ID's count will be incremented.
2. Or if you wish to use the Auto-Accumulate feature of the DFC or Auto-Hold functions, simply select an ID by either of the 2 methods described above before starting a DFC or Auto-Hold process and the final weight will be added to the selected ID's accumulator at the end of the cycle. The ID's weight counter will as well be incremented.

Clearing a Single ID's Accumulator/Counter:

1. Enter the "ID Review" mode by pressing the **RECALL** key from the weight display.
2. Continue stepping through the stored memory list by pressing the **RECALL** key until the ID whose accumulator you wish to clear is displayed.
3. Press the **MEM** key to display the current accumulation associated with that ID.
4. With the ID's accumulator displayed, press the **ZERO/CLEAR** key.
5. The indicator will display prompt *CLRACC* (clear accumulator?). Press the **ENTER** key to respond to this prompt. The default answer to this question is **NO**. To confirm you want to clear the annunciator, press the **1/YES** key then press the **ENTER** key. If you answered **NO**, the accumulators will not be cleared. If you answered **YES**, the accumulator and the weight counter associated with that ID will be reset to 0.
6. The indicator will return to "ID review" mode and display the ID you were modifying.
7. Press the * key to exit this mode.

Erasing a Stored ID:

1. While displaying weight press the **RECALL** key to enter "ID Review" mode.
2. Continue stepping through the stored memory list by pressing the **RECALL** key until the ID you wish to erase is displayed.
3. Press the **ZERO/CLEAR** key.
4. The indicator will display prompt *CLR ID* (Clear ID?). Press the **ENTER** key to respond to this prompt. The default answer to this question is **NO**. To confirm you want to clear the ID, press the **1/YES** key and then the **ENTER** key. If you answered **YES**, the stored ID is no longer in memory. If you answered **NO**, the memory is not affected.
5. No matter the answer, the indicator will exit "ID Review" mode and return to displaying weight.

Printing a Single Stored ID:

1. While displaying weight press the **RECALL** key to enter "ID Review" mode.
2. Continue stepping through the stored memory list by pressing the **RECALL** key until the ID you wish to print is displayed.
3. Press the **PRINT/ACCUM** key.
4. The indicator will print that ID, accumulator, and weight counter in the format shown below.
5. Press the ***** key to exit this mode.

11:14 AM	02/08/2011
ID: COWS	
Last Wt:	2032 LB
Accum Wt:	14876 LB
Weigh Cnt:	8

Printing All Stored IDs:

1. While the indicator is displaying weight, press the **MEM** key followed by the **PRINT/ACCUM** key. All of the stored IDs will print out alphabetically in the format shown below.

```
MEMORY REPORT
11:19 AM    02/08/2011

ID: CHICKN
Last Wt:    12 LB
Accum Wt:   413 LB
Weigh Cnt:  32

ID: COWS
Last Wt:    2032 LB
Accum Wt:   14876 LB
Weigh Cnt:  8

ID: PIGS
Last Wt:    914 LB
Accum Wt:   10639 LB
Weigh Cnt:  12
```

Accumulator Statistics for Stored IDs:

You can access the accumulator statistics (*A-STAT*) menu by pressing **F** key followed by the **RECALL** key while the indicator is displaying weight.

If no ID's have yet been stored in memory, the indicator will display "*NO IDS*" then display weight.

Pressing the **RECALL** key will step through 3 other headings:

- **TOT. WT** – Sum of all accumulators stored in memory ID files.
 - **TOT.CNT** – Sum of all count values stored in memory ID files.
 - **AVG.TOT** – Average Total = $TOT.WT / TOT.CNT$.
-
- Pressing the **ENTER** key while any of these headings are displayed will display that value.
 - Pressing the **ENTER** key again will step to the next heading.
 - Pressing **PRINT** at any time while in the *A-STAT* menu will print these stat values.
 - Pressing ***** at any time while in the *A-STAT* menu will exit and display weight.
 - Pressing **CLEAR** at any time while in the *A-STAT* menu will prompt the user *CLRALL*.
 - If the user answers **YES**, all memory file accumulators and counters will be cleared.



NOTE: ID's and Presets are **NOT** cleared from memory. If the user answers NO, the indicator will return to the previous *A-STAT* screen shown.

4. SERVICE

4.1 Troubleshooting

The Cardinal 212/212X Weight Indicator has been designed to provide you with years of trouble-free operation. However, should you experience a problem, please refer to the troubleshooting guide below before you call for service. The following describes several types of symptoms along with suggested remedies.

PROBLEM	POSSIBLE SOLUTIONS
Display does not turn on	Check if the 12VDC power cable is wired correctly. Is the battery discharged? Recharge or replace.
Incorrect weight displayed	<ol style="list-style-type: none"> 1. Has the indicator been calibrated? 2. Insure that the scale platform isn't touching an adjacent object. 3. Check the load cell connector wiring. 4. If using four (4) wire load cells, insure the sense lead jumpers (J6 & J9) are installed. 5. Have proper operation procedures been followed?
Indicator will not display weight	Refer to Error and Status Message section and make certain that the "OCCAP" message is not displayed. If so, and scale is not loaded, perform the calibration procedure.

Error and Status Messages

The Cardinal 212/212X Weight Indicator is equipped with diagnostic software program that tests various portions of the indicator's circuitry and verifies proper operation. Should a problem be detected or an error in the operation occur, an error or status message will be displayed alerting the operator to that condition. The following lists the error and status messages displayed and their meaning.

Display Message	Cause (A.) and Corrective Action (B.)
<i>ERROR</i>	<p>A. An illegal function was performed or an invalid keypad entry was attempted.</p> <ol style="list-style-type: none"> 1. The TARE key was pressed to enter a push button tare with a negative weight. 2. An attempt was made to enter a tare weight value that exceeds the scale capacity. 3. Attempting to enter a Tare weight value that is inconsistent with the scale division value. (e.g. entering a tare of 3 lbs with scale divisions of 5 lbs). 4. Attempting to tare scale when there is motion present or the Gross weight is below zero or over capacity. 5. Attempting to print when scale is over capacity or a negative weight. 6. Attempting to zero scale when there is motion present or the scale is over capacity. 7. Attempting to start the Digital Fill Control in the Unload mode when there is not enough material on the scale to complete a fill cycle. <p>B. Determine which of the reasons for the error display is applicable and take the appropriate corrective action.</p>
<i>PAUSED</i>	<p>A. This message is displayed to indicate a digital fill cycle has been paused.</p> <p>B. Press the HOLD key to resume fill or the * key to abort the fill.</p>

Error	Cause (A.) and Corrective Action (B.)
<i>NO IDS</i>	<p>A. This message is displayed to indicate that no ID memory files have been created when trying to access a memory location.</p> <p>B. Refer to section 8.6 Using Memory/ID Storage to create an ID memory file.</p>
<i>NOTARE</i>	<p>A. The NET/GROSS key was pressed when there is no stored tare.</p> <p>B. Perform either a push button tare operation or using the numeric keypad enter a new tare weight value.</p>
<i>OCAP</i>	<p>A. The load on the scale exceeds the capacity of the scale.</p> <p>B. Remove the excess load. Note that this could indicate the scale may need recalibrated.</p>
<i>-OF-</i>	<p>A. The indicator is trying to display a positive number with more than six digits or a negative number with more than five digits.</p> <p>B. Return to Gross weight mode and review the Tare weight. Might indicate incorrect calibration.</p>
<i>UNSTB</i>	<p>A. Motion is present when trying to power up, print, zero the scale or perform a push button tare function.</p> <p>B. Wait for a stable indication before printing.</p>

Error	Cause (A.) and Corrective Action (B.)
<i>CONFIG</i>	<p>A. Indicates improper stored calibration data, calibration required.</p> <p>B. Calibrate the scale with test weights. Consult your scale service provider.</p>
<i>ERRR H</i>	<p>A. The load cell input is above the range of the indicator. This may indicate a bad load cell or circuit failure.</p> <p>B. Check for improper load cell wiring or excessive load. Consult your scale service provider.</p>
<i>ERRR L</i>	<p>A. The load cell input is below the range of the indicator. This may indicate a bad load cell or circuit failure.</p> <p>B. Check for improper load cell wiring. Consult your scale service provider.</p>
<p style="text-align: center;">*</p> <p>Lo Bat</p>	<p>A. The * (asterisk) on the lower left side of the 212 display or the Lo Bat annunciator on the 212X is used to indicate the battery does not have a sufficient charge.</p> <p>B. The battery should be charged or replaced.</p>
Lo bat	<p>A. This will be displayed just before the battery voltage drops to a level where operation is affected. At this level, the indicator will automatically turn OFF.</p> <p>B. The battery will need to be charged or replaced before operations can continue.</p>

4.2 Care and Maintenance

- ⊘ **DO NOT** submerge the indicator in water, pour or spray water directly on the indicator.
- ⊘ **DO NOT** use acetone, paint thinner or other volatile solvents for cleaning the indicator.
- ✓ **DO** clean the indicator with a damp soft cloth and a mild non-abrasive detergent.
- ✓ **DO** remove power from the indicator before cleaning with a damp cloth.

4.3 Parts

Rear Sub-Assembly

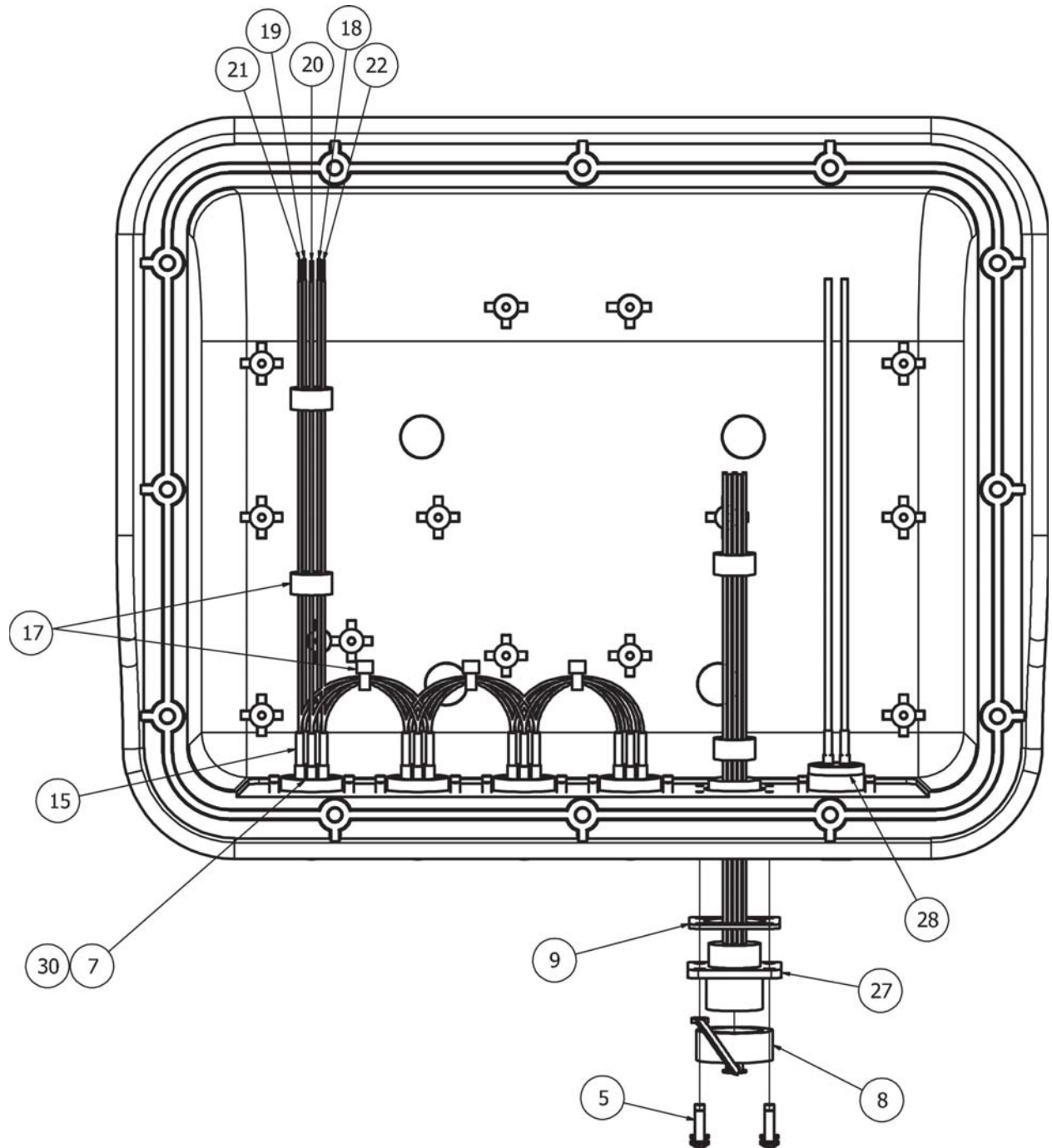

Rear Sub-Assembly

Item	Qty 212-1S 212X-1S	Qty 212-4S 212X-4S	Part Number	Description
5	12	24	6021-1290	SCW PAN-HEAD PLASTIC THD. ROLLING, #4x3/8, PHIL. DR. Z/P
7	-	4	6610-2116	CONN 05 PIN CIRCULAR (CXS3102A14S-5S300) PANEL, SOCKET CONTACT, NYLON SHELL, ENVIRONMENTAL
8	1	1	6610-2126	CAP, PLASTIC CONN SEALING W/CHAIN, 11 SHELL
9	1	1	6610-2129	CONN GASKET 12S SHELL MIL-C-5015
15	-	0.52'	6710-0001	SHRINK TUBING 3/32" BLACK
17	-	5	6980-0014	CABLE TIE 4" WHITE
18	-	1.6'	6980-0150	WIRE 24GA 7/32 STRAND. BLK PVC -UL1061
19	-	1.6'	6980-0151	WIRE 24GA 7/32 STRAND. RED PVC -UL1061
20	-	1.6'	6980-0152	WIRE 24GA 7/32 STRAND. WHT PVC -UL1061
21	-	1.6'	6980-0153	WIRE 24GA 7/32 STRAND. GRN PVC -UL1061
22	-	1.6'	6980-0155	WIRE 24GA 7/32 STRAND. YEL PVC -UL1061
27	1	1	8200-B612-0A	CABLE: I/O, 212 SERIES
28	1	1	8200-B613-0A	CABLE: POWER, 212 MAIN
30	1		8200-B643-0A	CABLE: 1 LOAD CELL, 212
33	-	1	8200-D608-28	PLASTIC ENCLOSURE: 212-4S/212X-4S
36	1	-	8200-D608-58	PLASTIC ENCLOSURE: 212-1S/212X-1S

Front Sub-Assembly

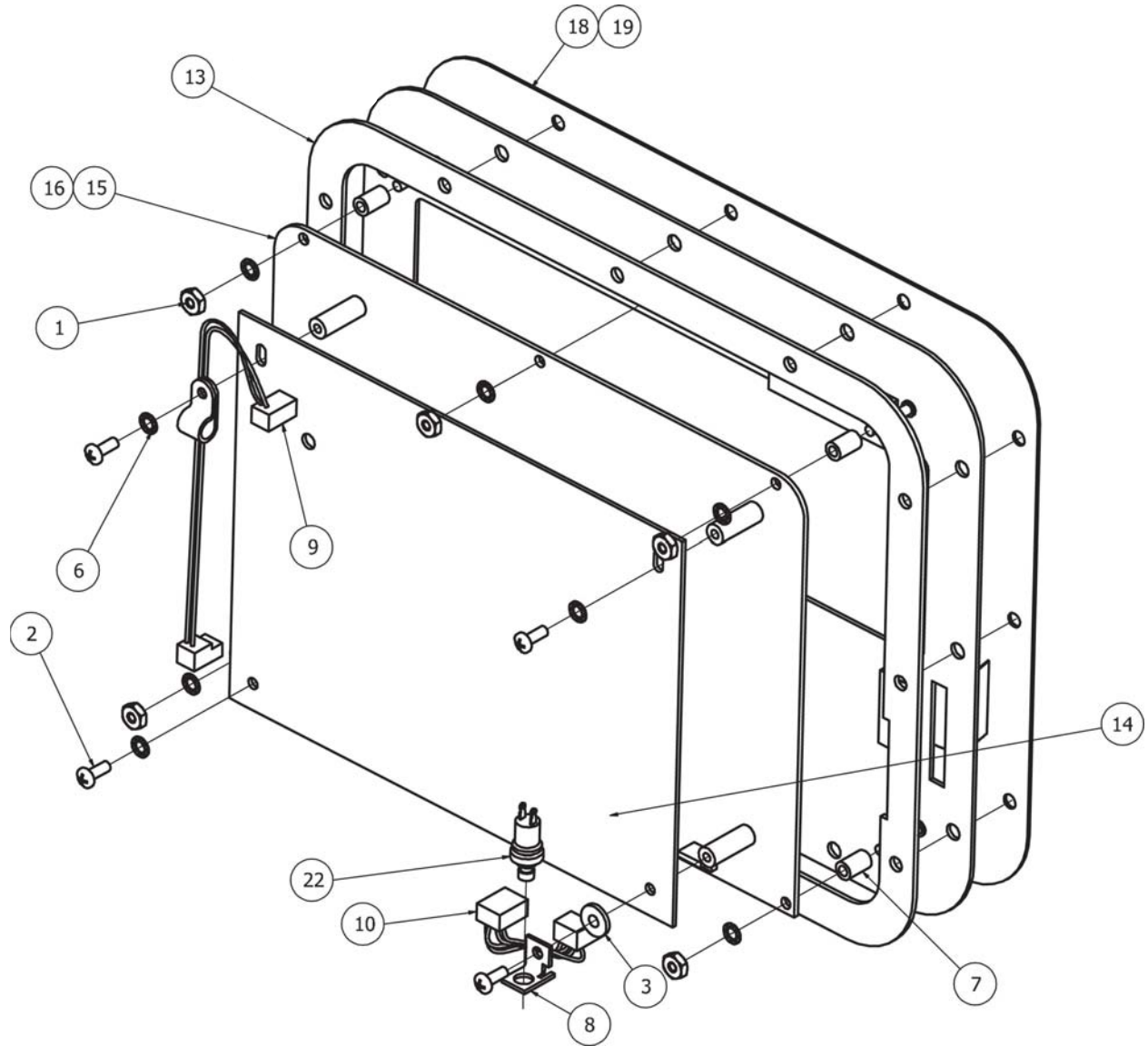

Front Sub-Assembly

Item	Qty 212-1S 212-4S	Qty 212X-1S 212X-4S	Part Number	Description
1	6	6	6013-0039	NUT #6-32 HEX
2	4	4	6021-0665	SCW PAN-HEAD.. MACHINE SCW 06-32X.375
3	1	1	6024-0126	WASHER FLAT FOR 5/32 POP RIVET
6	9	9	6680-0004	WASHER LOCK INT TOOTH #6 TYPE A Z-PL
7	6	6	6680-0131	SPACER #6X.400 NYLON
8	1	1	8200-B276-08	BRACKET, CONNECTOR – WIPO INTERFACE BD
9	1	1	8200-B605-0A	CABLE: POWER, 212 TO 210
10	1	1	8200-B614-0A	CABLE: IIC 2.5"
11	1	1	8200-C609-0A	FRONT PLATE WELDMENT
13	1	1	8200-C618-08	GASKET, 212
14	1	1	8200-D124-3A	PCB ASSEMBLY – 210 CONTROLLER
15	1	-	8200-D600-0A	PCB: DISPLAY, 212
16	-	1	8200-D600-1A	PCB: DISPLAY, 212X
18	-	1	8200-D602-08	KEYPAD: 2" DISPLAY, 212X
19	1	-	8200-D610-08	KEYPAD: 0.8" DISPLAY, 212
22	1	1	8555-B053-0A	CABLE ASSEMBLY: CAL SWITCH

Final Assembly

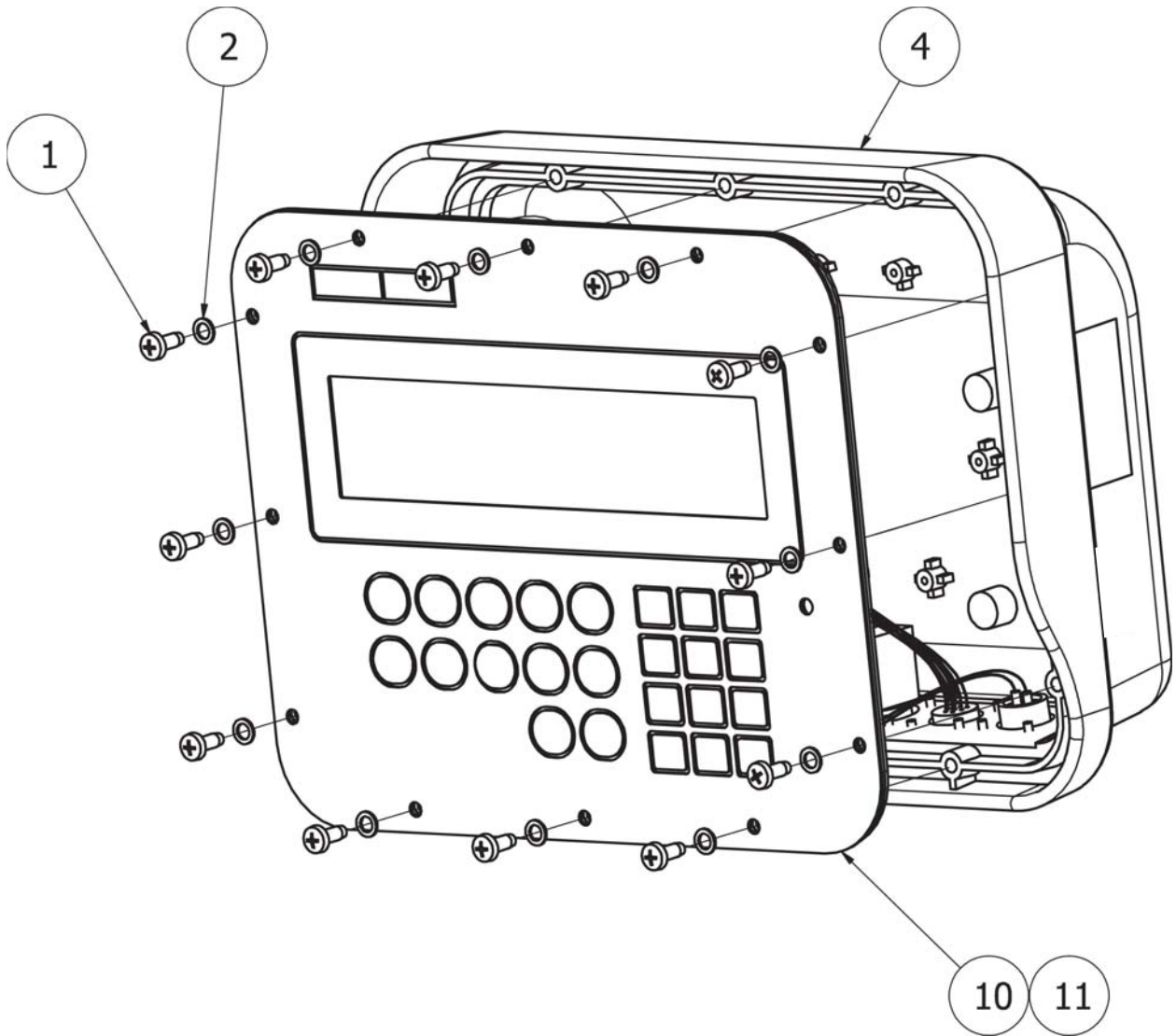

Final Assembly

Item	Qty 212-1S 212-4S	Qty 212X-1S 212X-4S	Part Number	Description
1	12	12	6021-1289	SCW PAN-HEAD PLASTIC THD. ROLLING, #10X1/2, PHIL. DR. Z/P
2	12	12	6024-0141	WASHER FLAT 0.345 OD, 0.218 ID, 0.032 THK NYLON
4	1	1	8200-D629-0A	REAR SUB-ASSEMBLY: 212-4S/212X-4S
10	1		8200-D630-0A	FRONT SUB-ASSEMBLY: 212 SERIES
11		1	8200-D630-1A	FRONT SUB-ASSEMBLY: 212X SERIES

STATEMENT OF LIMITED WARRANTY

WARRANTY TERMS

Cardinal Scale Manufacturing Company warrants the equipment we manufacture against defects in material and workmanship. The length and terms and conditions of these warranties vary with the type of product and are summarized below:

PRODUCT TYPE	TERM	MATERIAL AND WORKMANSHIP	LIGHTNING DAMAGE See note 9	WATER DAMAGE See note 7	CORROSION See note 4	ON-SITE LABOR	LIMITATIONS AND REQUIREMENTS
WEIGHT INDICATORS	90 DAY REPLACEMENT ----- 1 YEAR PARTS	YES	YES	YES	YES	NO	1, 2, 3, 5, 6 A, B, C, D
LOAD CELLS (Excluding Hydraulic)	1 YEAR	YES	YES	YES	YES	NO	1, 2, 3, 5, 6 A, B, C, D
HYDRAULIC LOAD CELLS (When purchased with Guardian Vehicle Scale)	LIFETIME	YES	YES	YES	YES	90 DAYS	1, 5, 6, 8 A, B, C, D
HYDRAULIC LOAD CELLS (When purchased separately)	10 YEARS	YES	YES	YES	YES	NO	1, 5, 6, 8, 9 A, B, C, D
VEHICLE SCALE (Deck and Below Excl. PSC Series)	5 YEARS	YES	YES	YES	YES	90 DAYS	1, 2, 3, 5, 6 A, B, C, D, E
LSC SCALE (Deck and Below)	3 YEARS	YES	YES	YES	YES	90 DAYS	1, 2, 3, 5, 6, 11 A, B, C, D
GUARDIAN FLOOR SCALES	10 YEARS	YES	YES	YES	YES	NO	1, 2, 3, 5, 6, 9, 10 A, B, C, D
ALL OTHER CARDINAL PRODUCTS	1 YEAR	YES	YES	YES	YES	NO	1, 2, 5, 6 A, B, C, D, E
REPLACEMENT PARTS	90 DAYS	YES	YES	YES	YES	NO	1, 2, 4, 5, 6 A, B, C, D
SWIM AND 760 SERIES VEHICLE SCALES	1 YEAR	YES	YES	YES	YES	90 DAYS	1, 2, 5, 6 A, B, C, D
SOFTWARE	90 DAYS	YES	N/A	N/A	N/A	NO	1, 6 B, C, D
CONVEYOR BELT SCALES (including Belt-Way)	1 YEAR	YES	YES	YES	YES	NO	1, 2, 3, 5, 6 A, B, C, D, E, F



CARDINAL

Ph. (800) 441-4237
E-mail: cardinal@cardet.com
102 E. Daugherty
Webb City, MO 64870

04/24
Printed in USA
315-WARRANTY-CAR-M

APPLICABLE LIMITATIONS AND REQUIREMENTS

1. This warranty applies only to the original purchaser. The warranty does not apply to equipment that has been tampered with, defaced, damaged, or had repairs or modifications not authorized by Cardinal or has had the serial number altered, defaced or removed.
2. This warranty is not applicable to equipment that has not been grounded in accordance with Cardinal's recommendations.
3. This equipment must be installed and continuously maintained by an authorized Cardinal / Belt-Way dealer.
4. Applies only to components constructed from stainless steel.
5. This warranty does not apply to equipment damaged in transit. Claims for such damage must be made with the responsible freight carrier in accordance with freight carrier regulations.
6. Warranty term begins with date of shipment from Cardinal.
7. Only if device is rated NEMA 4 or better or IP equivalent.
8. Lifetime warranty applies to damages resulting from water, lightning, and voltage transients and applies only to the hydraulic load cell structure itself (does not include pressure transducers, rubber seals, o-rings, and associated wiring).
9. 10-Year prorated warranty on hydraulic load cells.
10. 1-Year warranty for scale structure.
11. PSC models' warranty coverage applies only to agricultural installations on farms up to 3,000 acres (LSC models not limited in this manner).
12. Load cell kits MUST be installed in accordance with Cardinal Scale instructions. Failure to follow these instructions will void the warranty.

EXCLUSIONS

- A.) This warranty does not include replacement of consumable or expendable parts. The warranty does not apply to any item that has been damaged due to unusual wear, abuse, improper line voltage, overloading, theft, fire, water, prolonged storage or exposure while in purchaser's possession or acts of God unless otherwise stated herein.
- B.) This warranty does not apply to peripheral equipment not manufactured by Cardinal. This equipment will normally be covered by the equipment manufacturer's warranty.
- C.) This warranty sets forth the extent of our liability for breach of any warranty or deficiency in connection with the sale or use of our product. Cardinal will not be liable for consequential damages of any nature, including but not limited to loss of profit, delays or expenses, whether based on tort or contract. Cardinal reserves the right to incorporate improvements in material and design without notice and is not obligated to incorporate said improvements in equipment previously manufactured.
- D.) This warranty is in lieu of all other warranties expressed or implied including any warranty that extends beyond the description of the product including any warranty of merchantability or fitness for a particular purpose. This warranty covers only those Cardinal products installed in the forty-eight contiguous United States and Canada.
- E.) This warranty does not cover paint coatings due to the variety of environmental conditions.
- F.) Do not cut load cell cables on load cells returned for credit or warranty replacement. Cutting the cable will void the warranty.
- G.) Software is warranted only for performance of the functions listed in the software manual and/or the Cardinal proposal.
- H.) The software warranty does not cover hardware. Warranties on hardware are provided from the hardware vendor only.
- I.) The software warranty does not cover interfacing issues to non-Cardinal supplied hardware.
- J.) The software warranty does not include automatic software upgrades unless purchased separately.



Ph. (800) 441-4237
E-mail: cardinal@cardet.com
102 E. Daugherty
Webb City, MO 64870

04/24
Printed in USA
315-WARRANTY-CAR-M

Cardinal Scale Mfg. Co.

102 E. Daugherty, Webb City, MO 64870 USA

Ph: 417-673-4631 or 1-800-641-2008

Fax: 417-673-2153

www.cardinalscale.com

Technical Support: 1-866-254-8261

E-mail: tech@cardet.com

Printed in USA

8200-M639-O1 Rev D 09/14