



CARDINAL®



SPECTRUM



Truck/ID Storage

Versatile and extensive truck/ID storage reports with the 825 Spectrum.

Filter through truck/ID storage and accumulator data and view reports based on specific criteria directly onscreen in no time at all with the 825 Spectrum's speedy pair of 32-bit ColdFire® processors and 64 MB user memory. Sort by company name, truck number, fleet, ID, accumulator, time, date, oldest load or newest load. Reports may be viewed onscreen and/or printed, plus the truck storage database may be shared with a PC for creating, editing, sorting, and billing.



View Full Reports Onscreen

#	^ ID	Flags	Weight	Accum
1	CSMC1		12500	23200
2	CSMC2		10000	45000
3	CSMC3		12140	127650
4	CSMC4		8420	23420
5	CSMC5		11480	24880
6	CSMC6		8180	48740
7	CSMC7		9860	18480
8	CSMC8		10840	68400
9	CSMC9		6840	12740
10	CSMC10		11480	68940

Showing: 1-10 of 28 Page: 1/3

Flags:
(U)sed (T)emporary (S)ere Weight

Edit Filter Print Show Exit

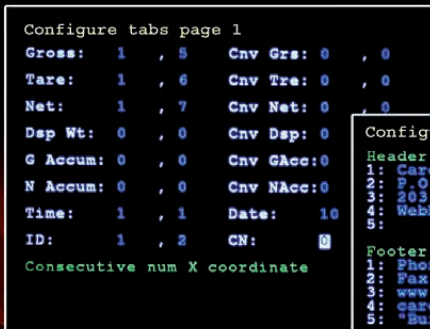

Convenient Ticket Setup

Complete ticket configurability in the 825.

Convenient tab settings with X-Y coordinates allow operators to set up tickets easily for any ASCII printer. Up to five lines of header and footer may be created for text, data, and control codes. Cardinal also offers **VISUALIZER** software for custom tickets.

Cardinal Scale Mfg.
P.O. Box 151
203 E. Daugherty
Webb City, MO 64870

TIME: 10:57am DATE: Nov. 17, 2008 ID: HWF1

GROSS: 10,257 lb
TARE: 4,389 lb
NET: 5,868 lb

Phone: (417) 673-4631
Fax: (417) 673-5001
www.825spectrum.com
cardinal@cardet.com
"Building a better weigh."

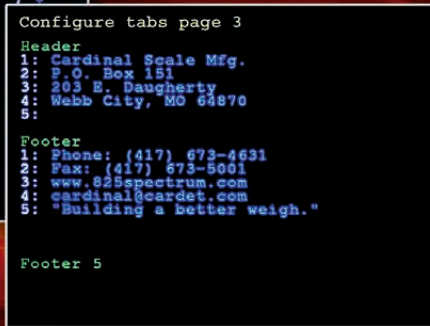

Type in Ticket Headers and Footers

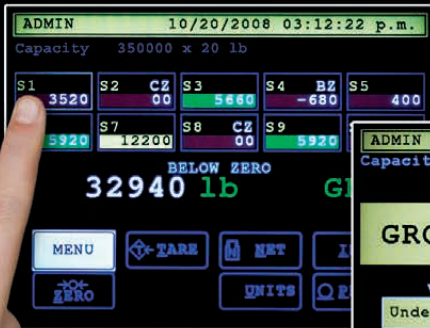

View up to 10 Scales Simultaneously

Cardinal's 825 Spectrum provides optimum inventory management for tank farms.

Instantly determine material inventory with the 825's ability to view 10 scales onscreen simultaneously. The power of the Spectrum's large 640 x 480 pixel color LCD becomes apparent when, in one scan of the eye, you can check on your entire tank farm's stocking levels. By touching a scale's weight onscreen, the indicator brings up the individual scale's information to set zone target values and ranges, zero weight, and apply tare weights.



Easily Access Individual Weights

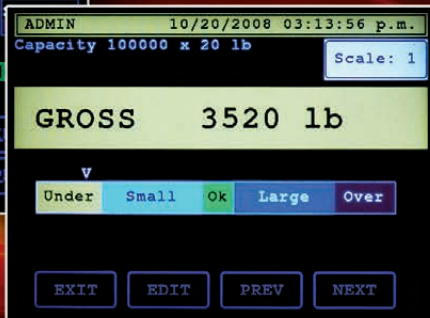

Intuitive Setup and Configuration Menus

The 825 Spectrum thinks like you do with intuitive setup and configuration menus.

The 825 Spectrum's large screen size provides ample space for detailed setup and configuration headers with descriptive choices about available options. You may set up the Spectrum with your own preference of onscreen colors and sounds using the convenient interactive touch screen and navigation keys. Up to eight operators (one administrator and seven configurable users) may be established for use with up to 25 levels of permission. The View Audit Trail section is useful for state inspectors and scale technicians providing information on calibration and parameter changes. Time and Date configuration is easy to set up with 12 or 24 hour operation.

Easy to Set Date and Time

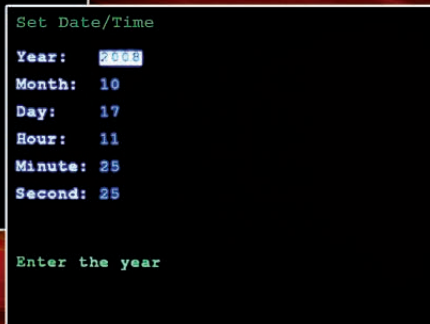



File Management Via Internal Web Server

Transfer data with the 825 Spectrum over a network or Internet connection:

In the Office • Across Town • Around the World

EASY DATA TRANSFER

Files stored on 825 Spectrum

Database file being transferred from USB drive



Cardinal model 825 Spectrum digital weight indicator

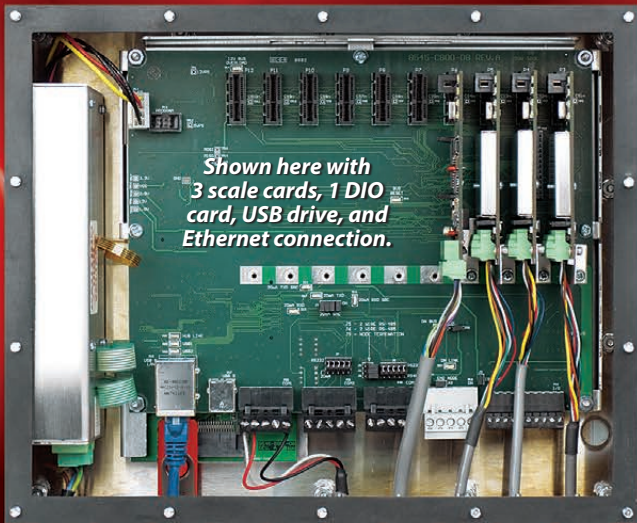

Shown here with 3 scale cards, 1 DIO card, USB drive, and Ethernet connection.



The 825 Spectrum's USB drive supports data transfer, USB QWERTY keyboards, and Cardinal-supported printers.

Copy files with ease to and from the indicator (bottom of 825 Spectrum shown to the left).

THE COMPLETE TRUCK SCALE SOLUTION



Connect to **REMOTE DISPLAY**

Connect to **TRUCK SCALE**

Connect to **REPORT PRINTER**

Connect to **TICKET PRINTER**

- 8 DIGITAL I/O (4 INPUT/4 OUTPUT)
- DEVICENET/ICAN
- 3 SERIAL PORTS (RS232/RS422)
- 64 MB USER MEMORY
- 10 OPTION SLOTS AVAILABLE
- OPTIONAL SCALE INPUT CARDS
- UP TO 8 GB USB MEMORY STORAGE
- ETHERNET CONNECTION (TCP/IP OR EIP)
- USB CONNECTION (2 USB-A / 1 USB-B)
- OPTIONAL 8 PROGRAMMABLE I/O'S

CONNECTIVITY

825 SPECTRUM



Cardinal Model 825



DIGITAL WEIGHT INDICATOR

SPECTRUM

SPECIFICATIONS

Power Requirements:	90 to 264 VAC (50/60 Hz)
Enclosure Type:	Stainless steel
Weight:	16.2 lb / 7.3 kg (includes gimbal)
Operating Environment:	Temperature: 14 to 104 °F (-10 to +40 °C) Humidity: 90% non-condensing (maximum)
Display Size:	5.25" W x 4.0" H / 133 mm W x 102 mm H
Display Resolution:	640 x 480 pixel matrix color backlit LCD
Transducer Excitation:	10.85 VDC
Load Cell Cable Length:	1260 feet maximum with sense lines 30 feet maximum without sense lines <i>Consult factory for other requirements</i>
Division Value:	1, 2, or 5 x 10, 1, 0.1, 0.01, 0.001 and 0.0001 commercial 0 to 99, non-commercial
Signal Input Range:	1.0 mV min. to 33 mV max. (with dead load boost)
Number of Load Cells:	Up to 14 per SIB / 48 - 350 ohm load cells total
Sensitivity:	
NON-COMMERCIAL	0.15 uV/e
CANADA	0.3 uV/e (Class III/IIHD)
OIML	0.5 uV/e (Class III)
Max Scale Divisions:	
NON-COMMERCIAL	240,000
CANADA	10,000 (Class III/IIHD)
OIML	10,000 (Class III), 1000 (Class III)
Internal Resolution:	>100,000 counts
Tare Capacity:	Six digits (999,999)
Sample Rate:	1 to 200 samples per second, selectable
Auto Zero Range:	0.5 or 1 through 9 divisions
Weighing Units:	Tons, pounds, tonnes (metric tons), kilograms, and custom
Keypad:	Membrane type with 52 color-coded keys and touch screen display with multiple programmable soft keys
Sound:	Configurable audio beep
Standard I/O:	<ul style="list-style-type: none"> 1 each bi-directional RS-232 port 1 each bi-directional RS-232/20mA port 1 each bi-directional RS-232/RS485 port 1 each DeviceNet/ICAN port 4 each isolated inputs and 4 each isolated outputs ports 1 each 10/100 Base-T Ethernet port (TCP/IP or EIP) 2 each USB A host port 1 each USB B device port

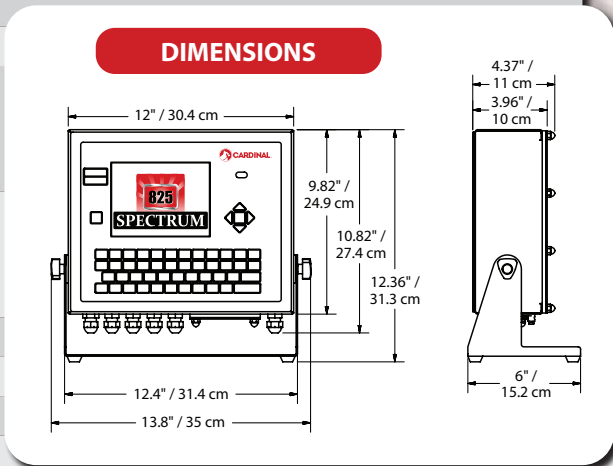

VISUALIZER
The 825 Spectrum may also use Cardinal's VISUALIZER Ticket and Label Generation Software

Cardinal Scale reserves the right to improve, enhance or modify features and specifications without prior notice. All registered trademarks are the property of their respective owners.

CERTIFICATIONS

08-046
 R76/1992-DK1-08.03
 AM-5700C
 REGISTERED 9001
 MADE IN USA of American and foreign components



SOLD BY:

102 East Daugherty St., Webb City, MO 64870 USA
 Toll-Free: (800) 441-4237 E-mail: cardinal@cardet.com
 www.CardinalScale.com