



CARDINAL®



C Series

Digital Counting Scale

Operation Manual

INTRODUCTION

Thank you for purchasing our Cardinal C Series Digital Counting Scale. Your scale is equipped with a rechargeable battery pack that is able to provide 100 hours continuous operation (with backlight on) or 200 hours continuous operation (with backlight off).

This manual will guide you through setup and operation of your scale. Please read it thoroughly before attempting to operate this scale and keep it handy for future reference.

Copyright

All rights reserved. Reproduction or use, without expressed written permission, of editorial or pictorial content, in any manner, is prohibited. No patent liability is assumed with respect to the use of the information contained herein.

Disclaimer

While every precaution has been taken in the preparation of this manual, the Seller assumes no responsibility for errors or omissions. Neither is any liability assumed for damages resulting from use of the information contained herein. All instructions and diagrams have been checked for accuracy and ease of application; however, success and safety in working with tools depend to a great extent upon the individual accuracy, skill and caution. For this reason, the Seller is not able to guarantee the result of any procedure contained herein. Nor can they assume responsibility for any damage to property or injury to persons occasioned from the procedures. Persons engaging the procedures do so entirely at their own risk.

FCC Compliance Statement

This equipment generates uses and can radiate radio frequency and if not installed and used in accordance with the instruction manual, may cause interference to radio communications. It has been tested and found to comply with the limits for a Class A computing device pursuant to Subpart J of Part 15 of FCC rules, which are designed to provide reasonable protection against such interference when operated in a commercial environment. Operation of this equipment in a residential area may cause interference in which case the user will be responsible to take whatever measures necessary to correct the interference.

You may find the booklet "How to Identify and Resolve Radio TV Interference Problems" prepared by the Federal Communications Commission helpful. It is available from the U.S. Government Printing Office, Washington, D.C. 20402. Stock No. 001-000-00315-4.

Proper Disposal

When this device reaches the end of its useful life, it must be properly disposed of. It must not be disposed of as unsorted municipal waste. Within the European Union, this device should be returned to the distributor from where it was purchased for proper disposal. This is in accordance with EU Directive 2002/96/EC. Within North America, the device should be disposed of in accordance with the local laws regarding the disposal of waste electrical and electronic equipment.

It is everyone's responsibility to help maintain the environment and to reduce the effects of hazardous substances contained in electrical and electronic equipment on human health. Please do your part by making certain that this device is properly disposed of. The symbol shown to the right indicates that this device must not be disposed of in unsorted municipal waste programs.



SPECIFICATIONS

Model:	Capacity and Division Value
C30	30 lb x 0.002 lb (15 kg x 1g)
C65	65 lb x 0.005 lb (30 kg x 2g)
C100	100 lb x 0.01 lb (50 kg x 5g)
Display:	WEIGHT = 6 Digits Avg Piece Weight = 6 Digits PIECES = 6 Digits
Scale Size:	13.39" W x 13.39" D x 5.00" H (340 mm x 340 mm x 127 mm)
Platform Size:	12.60" W x 9.06" D (320 mm x 230 mm)
Power:	Built-in rechargeable 6v/4Ah battery or 12VDC /110~240 VAC 50/60Hz AC adapter
Temperature:	32° ~ 104°F (0° ~ 40°C)
Humidity:	25% ~ 95% RH
Zero:	Established on power up routine and maintained by auto-zero circuitry
Tare:	100% of full-scale capacity
Remote Scale:	Maximum 10,000 divisions

Serial Number _____

Date of Purchase _____

Purchased Form _____

RETAIN THIS INFORMATION FOR FUTURE USE

PRECAUTIONS

Before using this scale, read this manual and pay special attention to all NOTIFICATION symbols:



IMPORTANT



ELECTRICAL WARNING

TABLE OF CONTENTS

INSTALLATION	1
Unpacking	1
Placement	1
Level Adjustment	1
AC Power Adapter	1
Remote Scale Interface	1
PRECAUTIONS	2
CARE AND CLEANING	2
KEY FUNCTIONS	3
ANNUNCIATORS	5
OPERATION	7
Power Switch	7
Metric Conversion	7
Weight Display	7
Displaying Weight	7
Zero the Weight display	7
Tare Weight Entry	8
Push Button Tare	8
Pre-set Tare with Known Weight of Container	8
Pre-set Tare with Container on Scale	8
Tare Weight of Empty Container on Remote Scale	8
To Clear Tare	8
Quantity Preset Hi Limit	9
Weight Preset Hi Limit	9
Clear the Quantity and Weight Preset Hi Limits	9
Counting	10
Counting When Weight of Sample Unknown	10
Counting When Sample Weight is Known	10
Counting with a Remote Scale	10
Counting with an Insufficient Sample	10
Accumulator	11
Adding to the Weight Accumulator	11
Displaying the Accumulator	11
Clearing the Accumulator	11
OPERATION USING PLU(S)	12
Add or Edit PLU	12
PLU Operation Using Numeric Keypad	12
PLU Operation Using Preset P1 through P8	12
SCALE SETUP	13
Accessing the Scale Setup Mode	13
CALIBRATION PROCEDURE	17
RECHARGEABLE LEAD-ACID BATTERY	24
Battery Charging	24
Low Battery	24
Notice	24
ERROR AND STATUS MESSAGES	25

INSTALLATION

Unpacking

Before beginning installation of your C Series Digital Counting Scale, make certain the scale has been received in good condition. Carefully remove the scale from the shipping carton and inspect it for any evidence of damage (such as exterior dents or scratches) that may have taken place during shipment. Keep the carton and packing material for return shipment if it should become necessary. It is the responsibility of the purchaser to file all claims for any damages or loss incurred during transit.

Placement

Place the scale on a stable, vibration-free level surface away from direct sunlight and from any rapidly moving air source (heating/cooling vents, fans, etc.). Make certain the power cord and peripheral cables are routed out of the way of normal traffic.



CAUTION! DO NOT place the scale on any unstable cart, stand or table. The scale may fall causing injury to the operator, and seriously damage the unit, or proper operation of the scale may be inhibited.

Level Adjustment

Check to make certain the scale is level. The level indicator is located at the front of the scale. If the scale is not level (the bubble will not be centered), loosen the locking ring on all four (4) mounting feet and adjust them as required to center the bubble and attain a level scale.

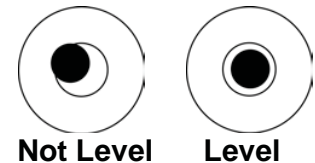

AC Power Adapter

The AC Power Adapter jack is located on the bottom left side panel in the opening adjacent to the Power Switch. Insert the plug from the adapter cord into the jack in the opening of the scale and then plug the power adapter into the proper electrical outlet.

Note that the scale also contains the circuitry necessary to monitor and recharge the battery and is capable of operating the scale and recharging the battery simultaneously.

NOTE: It is the responsibility of the customer to use the proper AC adapter plug for the wall receptacle.

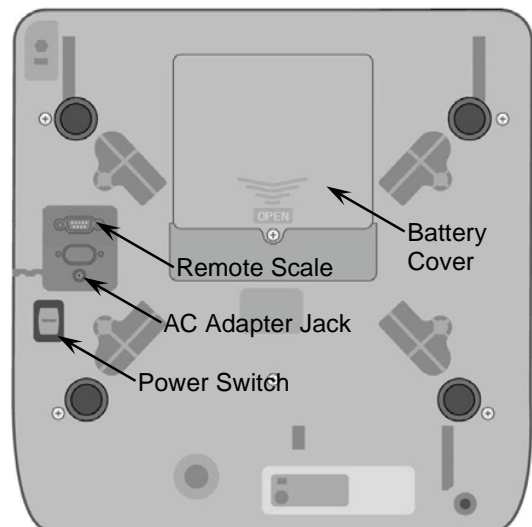

Remote Scale Interface

The Remote Scale Interface connector socket is located on the bottom left side panel in the same opening as the AC Power Adapter jack. Place the remote scale cable plug on the connector socket in the scale opening and secure with the two retaining screws on the scale cable plug.

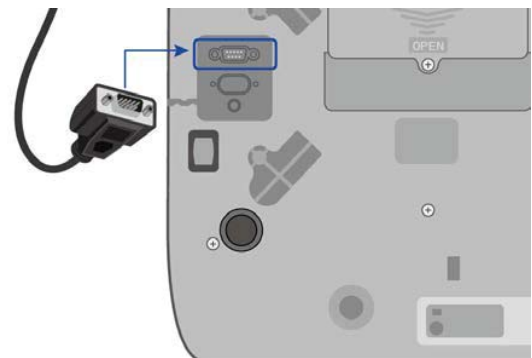

PRECAUTIONS

Most scales are designed for an office type environment. The C Series Digital Counting Scale is no exception to that rule. The following should be used as a guideline for the proper environment to operate your scale:

- The environment should be free of excessive dust and moisture.
- Provide a comfortable temperature. In general, the scale will perform well over a temperature range of 32 to 104° F (0 to +40° C).
- To keep cooling requirements to a minimum, the scale should be placed out of direct sunlight and to provide adequate air circulation, keep the area around the scale clear.
- Make certain the scale is not directly in front of a heating or cooling vent. Such a location will subject the scale to sudden temperature changes and air currents that may result in unstable weight readings.
- Insure that the scale has good, clean AC power and is properly grounded. In areas subject to lightning strikes, additional protection to minimize lightning damage, such as surge suppressors, should be installed.

CARE AND CLEANING

1. **DO NOT** submerge the scale in water, pour or spray water directly on it.
2. **DO NOT** use acetone, thinner or other volatile solvents for cleaning.
3. **DO** clean the indicator with a damp soft cloth and mild non-abrasive detergent.
4. **DO** remove power before cleaning with a damp cloth.
5. **DO** clean and store the scale in a plastic bag (in a dry environment) if the scale is not going to be used for some time. A desiccant packet may be included to prevent moisture build up.
6. **DO** recharge the internal battery every three months while in storage.

KEY FUNCTIONS

This section describes the use of each of the keys on the C Series Digital Counting Scale. It will be helpful to refer to the scale keyboard or the figure below when reading this section.

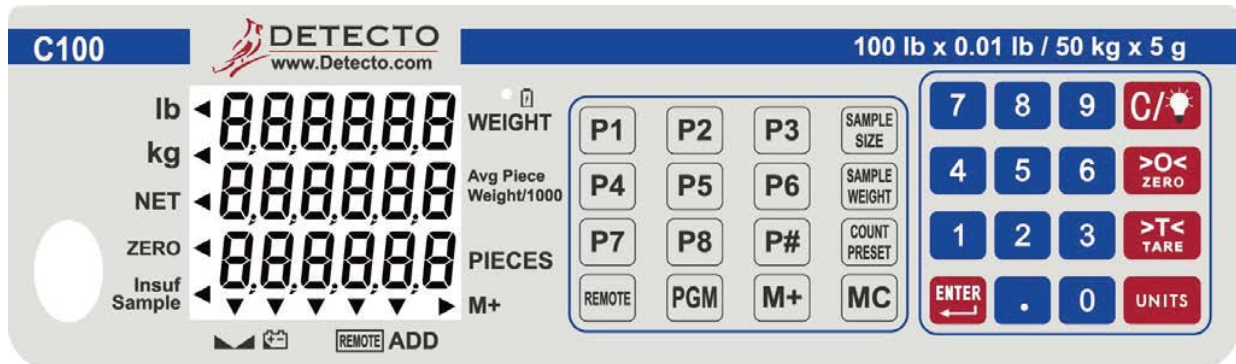

The membrane keyboard is not to be operated with pointed objects (pencils, pens, fingernails, etc.). Damage to keyboard resulting from this practice will **NOT** be covered under warranty.



- SAMPLE SIZE** This key is used to weigh a known number of pieces in preparation for a new counting operation. Sample quantities are entered using the numeric keypad in any quantity desired.
- SAMPLE WEIGHT** Pressing this key will display the calculated average piece weight from the current sampling and counting operation. It will also allow the manual entry of a known average piece weight (using the numeric keys) to be used in the next counting operation.
- COUNT PRESET** This key is used when setting the Quantity and Weight Preset limits. During a counting operation (with the limits set) if the quantity or weight exceeds the limits, the error beeper will sound and an error message will flash on the display.
- MC** The **MC** key is used to clear the accumulator. The M+ and ADD annunciators will turn off to indicate the clearing has taken place.
- M+** Pressing the **M+** key will cause the scale to display the contents of the accumulator (the number of pieces accumulated since the last time the accumulator was cleared).
- The **M+** key is also used to add the current piece count value to the accumulator. The M+ annunciator will be selected to indicate the accumulation has taken place.
- REMOTE** Pressing this key will select the optional Remote Scale for sampling, counting or weighing operations. The Remote Scale annunciator will illuminate to indicate the Remote Scale is in use. **NOTE:** The Remote scale cannot be selected until it has first been configured in the Calibration Procedure and then calibrated.



KEY FUNCTIONS, CONT.

PGM The PGM key is used to add or edit product look up (PLU) numbers. Up to 99 PLU numbers can be programmed. Note that the first 9 PLU's are assigned to the P1-9 keys and that all PLU's can be selected using the numeric keys.

P1 to P8 Pressing these keys will cause the scale to recall the average piece weight along with the saved tare weight (if a tare weight was programmed) associated with the product look up (PLU) number assigned to the key.

P# Pressing the **P#** key will cause the scale to recall the average piece weight along with the saved tare weight (if a tare weight was programmed) associated with the product look up (PLU) number.

C /  The **C / ** key is used to perform different functions depending on the current mode of operation:

- *Data Entry.* The **C / ** key is used to clear an incorrect entry from the display without processing the data. If an incorrect entry is made, press the **C / ** key and re-enter the correct data.
- Pressing and holding the **C / ** key for 3 seconds will toggle the display backlight on and off.

>0<
ZERO The **ZERO** key is used to perform a variety of functions depending on the current mode of operation:

Weight Display Mode (lb or kg annunciator on): Pressing the ZERO key will set the weight display to zero and turn on the ZERO annunciator if the displayed weight is within $\pm 4\%$ of scale capacity.

>T<
TARE The **TARE** key is used to display the current tare weight (or zero if no tare has been entered) and/or using the numeric keypad, to enter a new tare weight. It is also used when entering a tare under a Preset number.

UNITS Pressing this key will toggle the weighing units between pounds (lb) and kilograms (kg). The currently selected weighing unit is indicated by illuminating either the lb or kg annunciator.

0 ~ 9 These keys are used to enter numeric data during normal operations as well as during calibration and operational setup.

- This is the decimal point key. It is used to enter a decimal point where required when entering numeric data.

Enter
 The **Enter/↵** key is used to signal completion of the entry of data and causes the scale to process the data entered.

ANNUNCIATORS

The annunciators are turned on to indicate that the scale is in the mode corresponding to the annunciator label or that the status indicated by the label is active. It will be helpful to refer to the scale keyboard when reading this section. The following describes the functions of each annunciator.

lb

The lb annunciator is illuminated to show that the weight displayed is in pounds. The **UNITS** key may be used to select pounds as the weighing units.

kg

The kg annunciator is illuminated to show that the weight displayed is in kilograms. The **UNITS** key may be used to select kilogram as the weighing units.

NET

The NET annunciator is illuminated to show that the weight displayed is the net weight. Net weight is determined by subtracting the stored tare weight from the gross or scale weight. The tare weight, usually the weight of the container, is entered using the tare key. Note that the NET annunciator is only active when a zero-tare weight or tare weight value is stored and the display is in the weight mode as shown by the illumination of the lb or kg annunciator.

ZERO (Center-of-Zero)

The Center-of-Zero annunciator is located on the left of the display and is illuminated to indicate that the weight is within +/- 1/4 division of the center of zero.

Insuf Sample

The Insuf Sample annunciator is located on the lower left of the display and is illuminated to show that the sample is too small to calculate an accurate piece weight. If the counting function is continued without increasing the sample size, the scale will still operate even though accuracy will be affected.

(Stable)

The (Stable) annunciator is located at the bottom left of the display and is illuminated when the WEIGHT display is stable.

(Low Battery)

The Low Battery annunciator will illuminate to indicate that the internal battery requires charging. No change in operation will occur until just before the battery voltage drops to a level where operation is affected. At this level, the scale will automatically turn itself off.

When the battery requires charging, the CHARGING LED will turn Red. After the battery has been recharged, the CHARGING LED will turn Green.

REMOTE

The REMOTE Scale annunciator is located at the bottom of the display and is illuminated when the optional remote scale has been selected for use. The remote scale is selected by pressing the **REMOTE** key.

ANNUNCIATORS, CONT.

ADD

The ADD annunciator is located at the bottom right of the display and is illuminated when the scale is in the accumulator mode (M+).

M+

The M+ annunciator is located on the lower right of the display and is illuminated to show that the display is in the Accumulator mode and that the value displayed is the current contents of the accumulator. Individual counts are adjusted via the (M+) and (MC) keys or optionally, any count may be entered using the numeric keypad. Note that when both the M+ and ADD annunciators are illuminated, the current count has been added to the accumulator.

OPERATION

Power Switch

The Power Switch is located on the bottom left side panel towards the front of the scale.

Place the power switch in the on position. The scale will perform a brief lamp test. This test consists of illuminating all display segments and annunciator LED's to allow the operator to make a visual verification that the display is operational.

After completion of the lamp test, the scale will display the model number and software revision level and then the WEIGHT display will change to show zero weight, indicating the scale is ready for use.

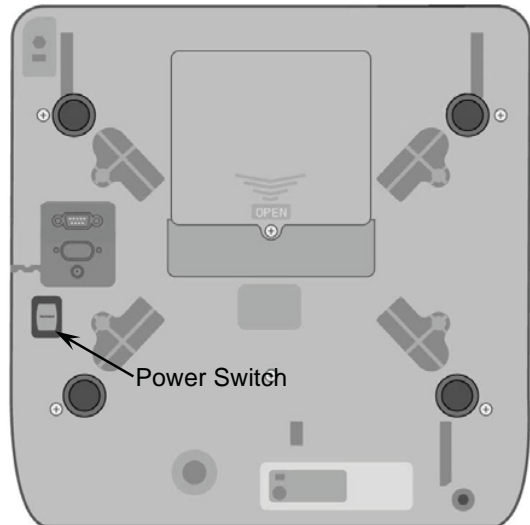

Metric Conversion

To change weighing units, press the **UNITS** key to toggle between pounds and kilograms. Note that either the LB or KG annunciator will illuminate to indicate which weighing unit is active.



Before using the scale, it should be “warmed up” (turned on and unloaded for approximately 15 to 20 minutes).

WEIGHT Display

Displaying Weight

1. With the scale in the Weight mode (0.0000 will be displayed for WEIGHT and 0 will be displayed for the Avg Piece Weight and PIECES displays), place the item to be weighed on the scale platform.
2. The display will show the weight on the scale platform. The lb or kg annunciators will illuminate to indicate which unit of weight has been selected and that the scale is in the Weight mode. Note that the Avg Piece Weight and PIECES display will remain at 0 (zero).

Zero the WEIGHT Display

1. With the scale in the Weight mode (0 will be displayed for the Avg Piece Weight and PIECES displays), press the **ZERO** key.
2. The WEIGHT display will show 0.0000 and the ZERO and Stable annunciators will illuminate, indicating a center-of-zero, stable gross weight condition.

OPERATION, CONT.

Tare Weight Entry

Push Button Tare

1. With the scale in the Weight mode, place the empty container on the scale platform.
2. Press the **TARE** key. The WEIGHT display will change to zero and the NET annunciator will turn on, indicating net weight is being displayed. The empty container's weight has been saved as the "tare weight".
3. Proceed with the counting or weighing operation.

Pre-set Tare with Known Weight of Container

1. With the scale in the Weight mode, press the **TARE** key. The display will change to show *P r E t R* and the PIECES display will show - - - - - (six dashes).
2. Using the numeric keypad, enter the desired tare (container) weight.
3. After the desired tare value has been entered, press the **TARE** key. The display will show the Net weight (Gross minus tare) and the NET annunciator will illuminate.
4. Proceed with the counting or weighing operation.

Pre-set Tare with Container on Scale

1. With the scale in the Weight mode, place the container on the scale.
2. Read the weight of the container.
3. Using the numeric keypad, enter the container weight and press the **TARE** key.
4. The display will show the Net weight (Gross minus tare) and the NET annunciator will illuminate.
5. Proceed with the counting or weighing operation.

Tare Weight of Empty Container on Remote Scale

1. With the scale in the Weight mode, press the **REMOTE** key.
2. Place the empty container on the remote scale platform.
3. Press the **TARE** key.
4. The WEIGHT display will change to zero and the NET annunciator will turn on, indicating net weight is being displayed. The empty container's weight has been saved as the "tare weight"
5. Proceed with the counting or weighing operation.

To Clear Tare

To return to a zero tare, simply remove all material from the scale platform (and remote scale platform), and then press the **TARE** key. This will reset the tare weight to zero.

OPERATION, CONT.

Quantity Preset Hi Limit

The scale can store a Quantity Preset Hi Limit value. The scale will beep and the Avg Piece Weight will display a blinking *- QTY -* if the quantity is over the Hi limit value set.

1. Press the **COUNT PRESET** key (items can be on scale or platform can be empty).
2. The WEIGHT display will change to show *PRESET*.
3. Using the numeric keypad, enter the Quantity Preset Hi Limit.
4. Press the **SAMPLE SIZE** key, followed by the **COUNT PRESET** key.
5. The scale will return to the Weight mode.

Weight Preset Hi Limit

The scale can store a Weight Preset Hi Limit value. The scale will beep and the Avg Piece Weight will display a blinking *- LPS -* if the weight is over the Hi limit value set.

1. Press the **COUNT PRESET** key (items can be on scale or platform can be empty).
2. The WEIGHT display will change to show *PRESET*.
3. Using the numeric keypad, enter the Weight Preset Hi Limit.
4. Press the **SAMPLE WEIGHT** key, followed by the **COUNT PRESET** key.
5. The scale will return to the Weight mode.

Clear the Quantity and Weight Preset Hi Limits

To clear the Quantity and/or Weight Preset Hi Limit, simply enter a "0" for the limit value.

OPERATION, CONT.

Counting Operation

Counting When Weight of Sample is Unknown

1. With the scale in the Weight mode, place the sample on the scale platform.
2. On the numeric keypad, enter the number of pieces in the sample.
3. While the display is blinking, press the **SAMPLE SIZE** key.
4. The display will change to show *SRPP*, and then show the average piece weight (per 1000 pieces) and the number of pieces.
5. Add the pieces to be counted and read the total count on the PIECES display.
6. Remove the pieces from the scale.
7. Press the **C /**  key to complete the counting operation and return to the Weight mode.

Counting When Weight of Sample is Known

1. With the scale in the Weight mode, using the numeric keypad, enter the piece weight of the sample.
2. Press the **SAMPLE WEIGHT** key.
3. Add the pieces to be counted and read the total count on the PIECES display.
4. Remove the pieces from the scale.
5. Press the **C /**  key to complete the counting operation and return to the Weight mode.

Counting with a Remote Scale

1. With the scale in the Weight mode, place the sample on the C Series scale platform.
2. Using the numeric keypad, enter the number of pieces in the sample.
3. While the display is blinking, press the **SAMPLE SIZE** key.
4. The display will change to show *SRPP*, and then show the average piece weight (per 1000 pieces) and the number of pieces.
5. Place the additional pieces to be counted on the remote scale platform.
6. Press the **REMOTE** key, and read the total count on the PIECES display.
7. Remove the sample from the C Series platform and the pieces from the remote scale platform.
8. Press the **C /**  key to complete the counting operation.

Counting with an Insufficient Sample



IMPORTANT! If the sample weight is too small the PIECES display will show - - - - - (six dashes) for a few seconds and then the Insuf Sample annunciator will illuminate. Continued use of the scale with the Insuf Sample annunciator

illuminated, will result in an “*inaccurate*” count. Press the **C /**  key to cancel the counting operation and return to the Weight mode. Increase the number of pieces for the sample and repeat the counting operation to achieve an “*accurate*” count.

OPERATION, CONT.

Accumulator

Adding to the Weight Accumulator

1. With the scale in the Weight mode and displaying zero weight, place the item on the scale platform.
2. Press the **M+** key to add to the value of the Weight Accumulator.
3. The Avg Piece Weight display will change to show the accumulator values and the ADD annunciator will be illuminated (to indicate the addition to the accumulator has taken place). After 3 seconds, the scale will return to the weight mode.
4. Remove the item from the scale.
5. The scale is ready for the next counting or weight operation.

NOTE: Additional Weight Accumulator additions cannot take place until the current weighing operation (scale weight returns to zero) has been completed.

Displaying the Accumulator

With the scale in the Weight mode and displaying zero weight, press the **M+** key to display the content of the accumulators. The values of the accumulator will be displayed for 3 seconds, then return to the Weight mode display.

Clearing the Accumulator

With the scale in the Weight mode and displaying zero weight, press the **MC** key. The accumulator will be reset to zero.

OPERATION USING PLU(S)

Add or Edit PLU

1. With the scale in the Weight mode, press the **PGM** key. The Weight display will change to show *PLU*.
2. Touch the P1 through 9 key or using the numeric keys, enter the desired number of PLU 10 through 99 to change and press the **ENTER** key. The PLU number will be shown on the Weight display.
3. Using the numeric keypad to enter the average piece weight and then press the **ENTER** key to accept it. Note that if the PLU currently has an average piece weight, you can press the **ENTER** key to accept it or change it at this time.
4. The PIECES display will change to show *LRrE*.
5. Press the **ENTER** key to accept it.
6. The next sequential PLU number will be displayed. Repeat steps 2 through 5 to program the remaining PLU's.
7. To exit PLU programming, simply press the PGM key and the scale will return to the normal weight mode.

PLU Operation Using Numeric Keypad

1. With the scale in the Weight mode, press the **P#** key. The Weight display will change to show *PLU*.
2. Enter the desired PLU number (1 through 99) and press the **ENTER** key.
3. The recalled PLU and average piece weight will display along with the associated tare weight (if a tare weight was programmed).
4. Add the pieces to be counted and read the total weight on the WEIGHT and the total count on the PIECES display.
5. Remove the pieces from the scale.
6. Press the **C /**  key to complete the counting operation and return to the Weight mode.

PLU Operation using Preset P1 through P8

1. With the scale in the Weight mode, press the desired **PLU** key P1 through P8.
2. The recalled PLU and average piece weight will display along with the associated tare weight (if a tare weight was programmed).
3. Add the pieces to be counted and read the total weight on the WEIGHT and the total count on the PIECES display.
4. Remove the pieces from the scale.
5. Press the **C /**  key to complete the counting operation and return to the Weight mode.

SCALE SETUP

Accessing the Scale Setup Mode

1. With the scale off, press and hold the **UNITS** key while switching the scale on.
2. Continue to hold the **UNITS** key until *SEtUP* is shown on the display.
3. Release the **UNITS** key. The display will change to show *SEtUP, btl .*

Use the following keys to navigate the Scale Setup Mode settings.

UNITS ↓ Accept the displayed setting and to proceed to next step

TARE → Toggles available settings for the current step

ZERO ↑ Returns to the previous step

C /  Exit setup and proceed to SAVE

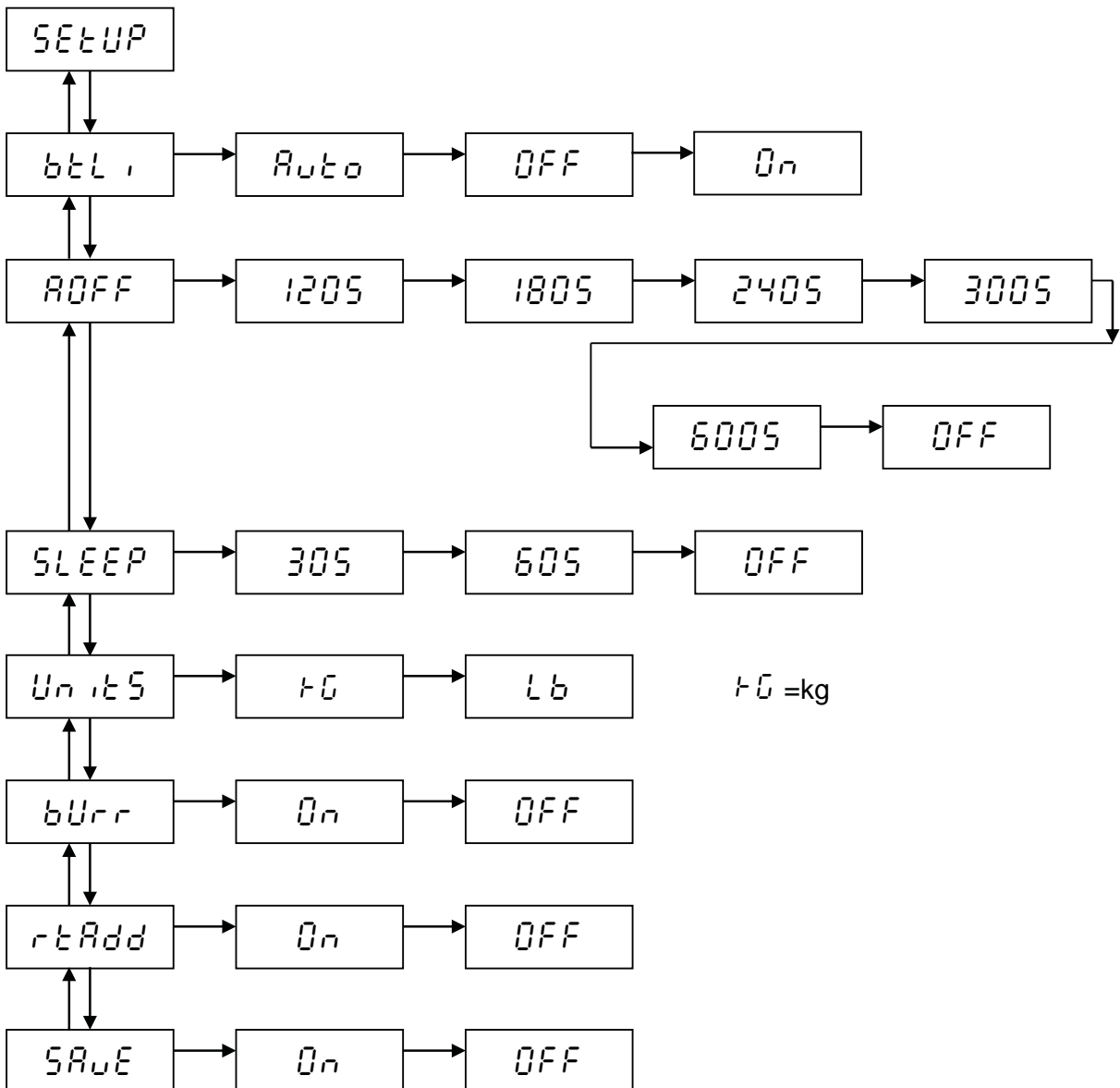

SCALE SETUP, CONT.

bEL , – Backlight Mode

With *SEtUP*, *bEL* , displayed the current setting for the Backlight Mode parameter will be shown. If the setting displayed is acceptable, press the **UNITS** key to proceed to the next parameter.

Otherwise, use the **TARE** key to toggle between the selections and then press the **UNITS** key to save it and proceed to the next parameter. The available settings are:

- Auto* = **Auto Backlight** – While weighing, the backlight will be turned ON automatically when the weight is over 10 divisions or any key is pressed. The backlight will turn OFF automatically when the scale has not been used for 10 minutes.
- OFF* = The will be no backlight (always OFF).
- On* = The backlight will always be ON.

ROFF – Automatic Power-Off

With *SEtUP*, *ROFF* displayed the current setting for the Automatic Shut-Off function parameter will be shown. If the setting displayed is acceptable, press the **UNITS** key to proceed to the next parameter.

Otherwise, use the **TARE** key to toggle between the selections and then press the **UNITS** key to save it and proceed to the next parameter. The available settings are:

- 120S* = After 120 seconds (2 minutes) of no activity the scale will shut off and must be turned on using the ON/OFF switch.
- 180S* = After 180 seconds (3 minutes) of no activity the scale will shut off and must be turned on using the ON/OFF switch.
- 240S* = After 240 seconds (4 minutes) of no activity the scale will shut off and must be turned on using the ON/OFF switch.
- 300S* = After 300 seconds (5 minutes) of no activity the scale will shut off and must be turned on using the ON/OFF switch.
- 600S* = After 600 seconds (10 minutes) of no activity the scale will shut off and must be turned on using the ON/OFF switch.
- OFF* = The Auto Shut-Off function is disabled.

SCALE SETUP, CONT.

SLEEP – Sleep Mode

With *SETUP*, *SLEEP* displayed the current setting for the Sleep Mode function parameter will be shown. If the setting displayed is acceptable, press the **UNITS** key to proceed to the next parameter.

Otherwise, use the **TARE** key to toggle between the selections and then press the **UNITS** key to save it and proceed to the next parameter. The available settings are:

- 30S* = If no activity occurs on scale for **30** seconds, the scale will enter Sleep Mode. The display will be blank except for a flashing cursor. To activate the scale, press any key or add/remove weight from scale.
- 60S* = If no activity occurs on scale for **60** seconds, the scale will enter Sleep Mode. The display will be blank except for a flashing cursor. To activate the scale, press any key or add/remove weight from scale.
- OFF* = The Sleep Mode function is disabled.

Unit – Weighing Units

With *SETUP*, *Unit* displayed the current setting for the Weighing Units parameter will be shown. If the setting displayed is acceptable, press the **UNITS** key to proceed to the next parameter.

Otherwise, use the **TARE** key to toggle between the selections and then press the **UNITS** key to save it and proceed to the next parameter. The available settings are:

- KG* = kg (Kilograms)
- LLb* = Lb (Pounds)

bUrr – Beeper

With *SETUP*, *bUrr* displayed the current setting for the Beeper parameter will be shown. If the setting displayed is acceptable, press the **UNITS** key to proceed to the next parameter.

Otherwise, use the **TARE** key to toggle between the selections and then press the **UNITS** key to save it and proceed to the next parameter. The available settings are:

- On* = Enable Beeper
- LOFF* = Disable Beeper

rEAdd – Return Add

With *SETUP*, *rEAdd* displayed the current setting for the Return Add parameter will be shown. If the setting displayed is acceptable, press the **UNITS** key to proceed to the next parameter.

Otherwise, use the **TARE** key to toggle between the selections and then press the **UNITS** key to save it and proceed to the next parameter. The available settings are:

- On* = The weight will to return to 0.0, then you can execute the M+
- LOFF* = You can execute the M+ even if the weight did not return to 0.0

SCALE SETUP, CONT.

SAVE – Save User Setup

With *SETUP*, *SAVE* displayed the current setting for the Save Setting parameter will be shown. If the setting displayed is acceptable, press the **UNITS** key to save the user settings.

Otherwise, use the **TARE** key to toggle between the selections and then press the **UNITS** key to save it and proceed to the next parameter. The available settings are:

- On* = The changes are saved and the scale is ready for use with the new settings.
- LOFF* = The changes are NOT saved and the scale will continue to operate with the *previous* settings.

The scale will reset and perform a lamp test. Next, the display will show the model number; the software revision level and then the WEIGHT display will show zero weight.

CALIBRATION PROCEDURE

To begin the calibration procedure, first remove the seal and the cover on the bottom of the scale. Next, locate the test pins and short the right side 2 pins to enter the calibration setting mode. The display will show *SETUP*, then *SCALE2, n0*.

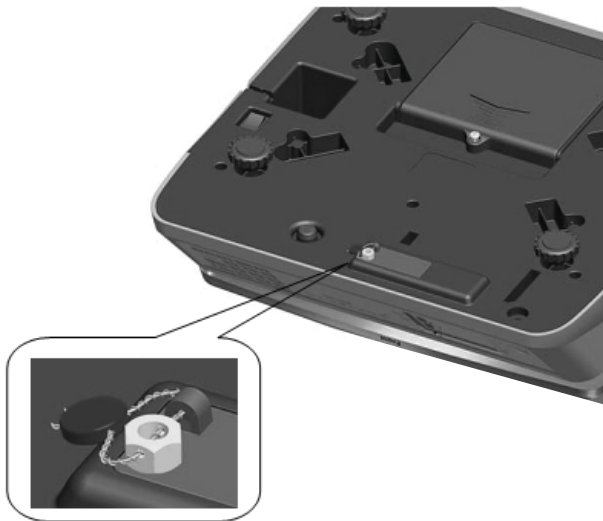

To enable the use of the remote scale, press the **TARE** key to toggle the selection to *YES*.

With the appropriate selection made, press the **UNITS** key seven (7) times until the display shows *SETUP, CAL-U*, the current setting for the Calibration Units parameter.

CAL-U – Calibration Units

With *SETUP, CAL-U*, the current setting for the Calibration Units parameter will be shown. If the setting displayed is acceptable, press the **UNITS** key to proceed to the next parameter.

Otherwise, use the **TARE** key to toggle between the selections and then press the **UNITS** key to proceed to the next parameter. The available settings are:

KG = kg (Kilograms)
LLb = Lb (Pounds)

CAP 1 – Local Scale Capacity

With *SETUP, CAP 1* displayed, the current setting for the Scale Capacity will be shown. If the setting displayed is correct, press the **UNITS** key to proceed to the next parameter.

Otherwise, use the **TARE** key to toggle between the selections and then press the **UNITS** key to save it and proceed to the next parameter. The available settings are:

30Lb = Scale capacity is 30 pounds
65Lb = Scale capacity is 65 pounds
100Lb = Scale capacity is 100 pounds

CALIBRATION PROCEDURE, CONT.

rES 1 – Local Scale Resolution

With *SETUP*, *rES 1* displayed the current setting for the scale resolution parameter will be shown. If the setting displayed is acceptable, press the **UNITS** key to proceed to the next parameter.

Otherwise, use the **TARE** key to toggle between the selections and then press the **UNITS** key to save it and proceed to the next parameter. The available settings are:

- 3000d* = Scale Resolution is 3000 divisions
- 6000d* = Scale Resolution is 6000 divisions
- 15000d* = Scale Resolution is 15000 divisions
- 30000d* = Scale Resolution is 30000 divisions

CRP2 – Remote Scale Capacity

With *SETUP*, *CRP2* displayed, the current setting for the Remote Scale Capacity will be shown. This display shows both the numeric capacity and the capacity units in the upper left of the display. If the setting displayed is correct, press the **UNITS** key to proceed to the next parameter.

Otherwise, use the numeric keypad to enter the desired capacity value. To toggle the units setting (typically needs to match the units of the local scale) press the **TARE** key. When these settings are as desired, press the **UNITS** key to save it and proceed to the next parameter.

rES2 – Remote Scale Resolution

With *SETUP*, *rES2* displayed the current setting for the remote scale resolution parameter will be shown. If the setting displayed is acceptable, press the **UNITS** key to proceed to the next parameter.

Otherwise, use the **TARE** key to toggle between the selections and then press the **UNITS** key to save it and proceed to the next parameter. The available settings are:

- 1d* = Remote Scale Resolution is one (1) division
- 2d* = Remote Scale Resolution is two (2) divisions
- 5d* = Remote Scale Resolution is five (5) divisions

CALIBRATION PROCEDURE, CONT.

SV – Normal Transmission SV Mode

With *SETUP*, *SV* displayed the current setting for the SV Mode Setting parameter will be shown. If the setting displayed is acceptable, press the **UNITS** key to proceed to the next parameter.

Otherwise, use the **TARE** key to toggle between the selections and then press the **UNITS** key to save it and proceed to the next parameter. The available settings are:

- On* = Enables SV Normal transmission, and its function. When the scale is turned on after the SAVE function, it will enter the SV mode. Display will show the weight applied and at the same time RS232 transmission will show discrimination value.
- LOFF* = Disables SV Normal transmission

GRAV – Enable Gravity Compensation

This scale is equipped with a gravity compensation function which means that it can be calibrated in one location and then adjusted to match the gravity at the location where it will be used.

With *SETUP*, *GRAV* displayed the current setting for the Gravity Compensation parameter will be shown. If the setting displayed is acceptable, press the **UNITS** key to proceed to the next parameter.

Otherwise, use the **TARE** key to toggle between the selections and then press the **UNITS** key to save it and proceed to the next parameter. The available settings are:

- On* = Enable Gravity Compensation
- LOFF* = Gravity Compensation is disabled

NOTE: If you enable Gravity Compensation two additional prompts will be displayed.

G-CAL – Calibrated Gravity

This is the gravity value of the location where the scale was calibrated.

With *SETUP*, *GRAV* displayed the current setting for the Calibrated Gravity parameter will be shown. If the setting displayed is acceptable, press the **UNITS** key to proceed to the next parameter.

Range is from 9.7000 to 9.8999. Note that the second digit can only be a 7 or 8.

Otherwise, using the numeric keys, enter a new value*. Use the **TARE** key to move to the next digit and then press the **UNITS** key to save it and proceed to the next parameter.

***Consult Tech Support for the calibration location gravity value.**

U-USE – Operating Gravity

This is the gravity value of the location where the scale will be operated.

With *SETUP*, *USE* displayed the current setting for the Operating Gravity parameter will be shown. If the setting displayed is acceptable, press the **UNITS** key to proceed to the next parameter.

Range is from 9.7000 to 9.8999. Note that the second digit can only be a 7 or 8.

Otherwise, using the numeric keys, enter a new value*. Use the **TARE** key to move to the next digit and then press the **UNITS** key to save it and proceed to the next parameter.

***Consult Tech Support for the operating location gravity values.**

CAL 1 – Calibrate Local Scale

With *SETUP*, *CAL 1* displayed the current setting for the Scale Calibration Setting parameter will be shown. If the setting displayed is acceptable, press the **UNITS** key to proceed to the next parameter.

Otherwise, use the **TARE** key to toggle between the selections and then press the **UNITS** key to save it and proceed to the next parameter. The available settings are:

On = Perform scale calibration
LOFF = Skip scale calibration

To begin calibration, select *On* and then press the **UNITS** key. The display will change to show *SETUP*, *CAL 1-0*, *107378* the Scale Zero Count.

CAL 1-0 – Local Scale Zero Count

With *SETUP*, *CAL 1-0* displayed the current setting for the Scale Zero Count will be shown.

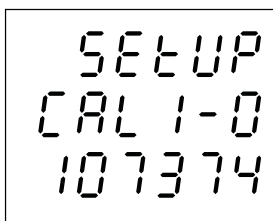

SETUP
CAL 1-0
107374

NOTE: The Zero Count shown is an example. Each scale will have a different zero count.

Press the **UNITS** key again. The display will change to show - - - - - (dashes) for a few seconds and then change to the prompt for the calibration weight

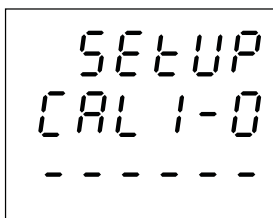

SETUP
CAL 1-0
- - - - -

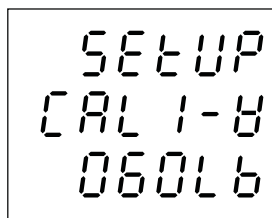
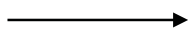

SETUP
CAL 1-8
06016

CALIBRATION PROCEDURE, CONT.

Use the numeric keys to change the calibration weight if desired. The following table is the recommended calibration weight required:

Scale Capacity (kg or lb)	Calibration Weight (kg or lb)*
15 kg or 30 lb	10 kg or 20 lb
30 kg or 65 lb	20 kg or 50 lb
50 kg or 100 lb	30 kg or 60 lb

* The default value for calibration weight depends on scale capacity.

When calibration weight setting is completed, press the **UNITS** key and then place the calibration weight on the scale platform.

The display will show span count.

```

SETUP
CAL 1-5
386749
    
```

***NOTE:** The span count shown is an example. Each scale will have a different span count.*

Press the **UNITS** key to start calibrating. The display will change to show `CAL 1` for a few seconds, then show `PASS` and then change to `SETUP, CAL 2` to calibrate the remote scale.

```

SETUP
CAL 1-5
CAL 1
    
```

→

```

SETUP
CAL 1-5
PASS
    
```

Remove the calibration weight from the scale platform

`CAL 2` – Calibrate Remote Scale

With `SETUP, CAL 2` displayed the current setting for the Remote Scale Calibration Setting parameter will be shown. If the setting displayed is acceptable, press the **UNITS** key to proceed to the next parameter.

Otherwise, use the **TARE** key to toggle between the selections and then press the **UNITS** key to save it and proceed to the next parameter. The available settings are:

- `On` = Perform remote scale calibration
- `LOFF` = Skip remote scale calibration

To begin calibration, select `On` and then press the **UNITS** key. The display will change to show `SETUP, CAL 2-0, 234 15` the Remote Scale Zero Count.

CALIBRATION PROCEDURE, CONT.

CAL2-0 – Remote Scale Zero Count

With **SETUP**, **CAL2-0** displayed the current setting for the Remote Scale Zero Count will be shown.

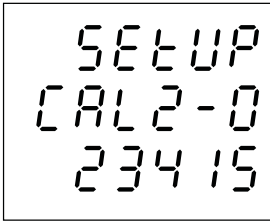

NOTE: The Zero Count shown is an example. Each remote scale will have a different zero count.

Press the **UNITS** key again. The display will change to show - - - - - (dashes) for a few seconds and then change to the prompt for the calibration weight

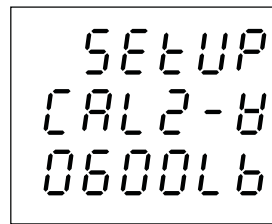
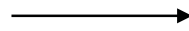
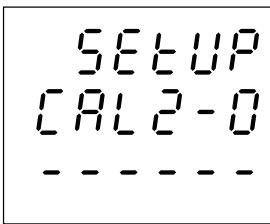

Use the numeric keys to change the calibration weight if desired. The following table is the recommended calibration weight required:

Scale Capacity (kg or lb)	Calibration Weight (kg or lb)*
30 kg or 60 lb	20 kg or 50 lb
60 kg or 150 lb	30 kg or 70 lb
150 kg or 300 lb	100 kg or 200 lb
300 kg or 600 lb	200 kg or 400 lb
500 kg or 1000 lb	300 kg or 600 lb

* The default value for calibration weight depends on scale capacity.

When calibration weight setting is completed, press the **UNITS** key and then place the calibration weight on the remote scale platform. The display will show span count.

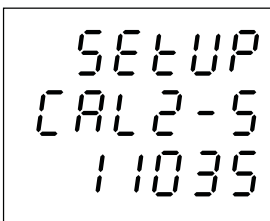

NOTE: The span count shown is an example. Each scale will have a different span count.

CALIBRATION PROCEDURE, CONT.

Press the **UNITS** key to start calibrating. The display will change to show *CAL2* for a few seconds, then show *PASS* and then change to *SETUP, SAVE* to save calibration.

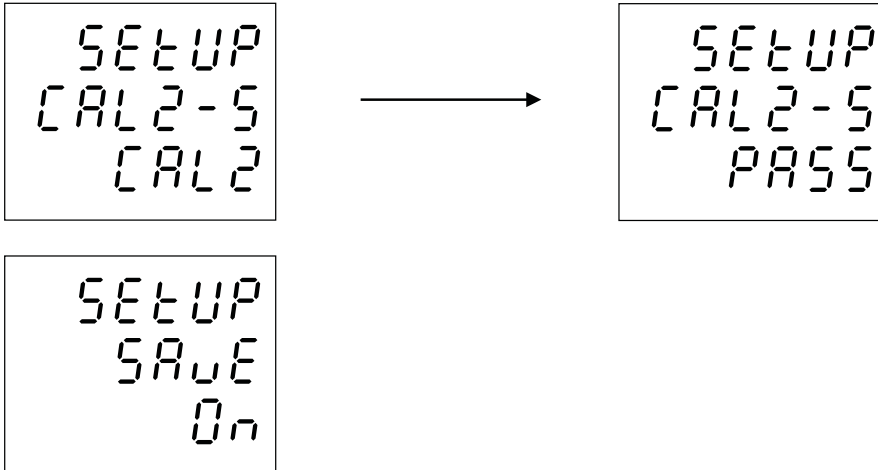

Remove the calibration weight from the remote scale platform

DEFLE – Reset all Setup Parameters to Default Setting

With *SETUP, DEFLE* displayed the current setting for the Default all Setup parameters will be shown. If the setting displayed is acceptable, press the **UNITS** key to save the calibration.

Otherwise, use the **TARE** key to toggle between the selections and then press the **UNITS** key to save it and proceed to the next parameter. The available settings are:

- On* = Resets all setup parameters to default settings.
- LOFF* = Does NOT reset all setup parameters to default settings.

The scale will reset and perform a lamp test. Next, the display will show the model number; the software revision level and then the WEIGHT display will show zero weight.

SAVE – Save Calibration

With *SETUP, SAVE* displayed the current setting for the Save Calibration setting parameter will be shown. If the setting displayed is acceptable, press the **UNITS** key to save the calibration.

Otherwise, use the **TARE** key to toggle between the selections and then press the **UNITS** key to save it and proceed to the next parameter. The available settings are:

- On* = The changes are saved and the scale is ready for use with the new settings and calibration.
- LOFF* = The changes are NOT saved and the scale will continue to operate with the *previous* settings and calibration.

The scale will reset and perform a lamp test. Next, the display will show the model number; the software revision level and then the WEIGHT display will show zero weight.

RECHARGEABLE LEAD-ACID BATTERY

Battery Charging

The scale can charge the battery (lead-acid rechargeable battery, 6v/4Ah). Just connect the scale to the external power supply to charge it. The battery will be charged regardless if the scale is on or off. It takes approximately 12 hours to charge the battery to full capacity depending on the voltage of the battery. If the battery has been-discharged, a prolonged charging time is required to bring the battery back to full capacity.



Red light: The battery is charging.

Green light: The battery is fully charged.

Low Battery

When the battery voltage falls below 5.7v, the low battery annunciator  will be turned on. The battery must be recharged. Continued use (approximately 15 minutes later), the display will show *Lo Bat* in the weight field. If the battery voltage drops too low for accurate weighing, the scale will automatically shut off and you will be unable to turn it back on. When the low battery indicator is displayed, the operator should plug the power supply into the scale and then into the proper electrical wall outlet. The scale will begin charging the battery.

Notice

The battery should be recharged at least every 5 months regardless if it is used or not. After a long storage, e.g. over 3 months, it is desired to cycle (charge/discharge) the battery 3 times to let it restore to full capacity.

When replacing the battery, pay much attention to the poles. The positive (+) terminal must be connected to the red connector and the negative (-) terminal must be connected to the black connector. If connected wrongly, the battery will be damaged.

NOTE: The battery cover can be removed by loosening a single captive screw. This screw remains attached to the cover which prevents it from falling out of the cover or being dropped and lost.

The capacity of the batteries will reduce over the years and therefore also the total operation time of the scale. This is not an error of the scale, but it is normal behavior of rechargeable batteries.

ERROR AND STATUS MESSAGES

The Cardinal C Series Digital Counting Scale is equipped with a diagnostic software program that tests various portions of the scale's circuitry and verifies proper operation. Should a problem be detected, an error or status message will be displayed alerting the operator to that condition. The following lists these error messages and their description.

ERROR MESSAGE	DESCRIPTION
<i>Err</i>	Over capacity
<i>Lo bAt</i>	Low battery
<div style="border: 1px solid black; padding: 2px; display: inline-block;">00000</div>	Zero value is too low when starting
<div style="border: 1px solid black; padding: 2px; display: inline-block;">00000</div>	Zero value is too high when starting
<i>ErrH</i>	Zero value is too high
<i>ErrL</i>	Zero value is too low
<i>ErrE</i>	EEprom Error
<i>ErrS</i>	Keypad Error

STATEMENT OF LIMITED WARRANTY

WARRANTY TERMS

Cardinal Scale Manufacturing Company warrants the equipment we manufacture against defects in material and workmanship. The length and terms and conditions of these warranties vary with the type of product and are summarized below:

PRODUCT TYPE	TERM	MATERIAL AND WORKMANSHIP	LIGHTNING DAMAGE See note 9	WATER DAMAGE See note 7	CORROSION See note 4	ON-SITE LABOR	LIMITATIONS AND REQUIREMENTS
WEIGHT INDICATORS	90 DAY REPLACEMENT ----- 1 YEAR PARTS	YES	YES	YES	YES	NO	1, 2, 3, 5, 6 A, B, C, D
LOAD CELLS (Excluding Hydraulic)	1 YEAR	YES	YES	YES	YES	NO	1, 2, 3, 5, 6 A, B, C, D
HYDRAULIC LOAD CELLS (When purchased with Guardian Vehicle Scale)	LIFETIME	YES	YES	YES	YES	90 DAYS	1, 5, 6, 8 A, B, C, D
HYDRAULIC LOAD CELLS (When purchased separately)	10 YEARS	YES	YES	YES	YES	NO	1, 5, 6, 8, 9 A, B, C, D
VEHICLE SCALE (Deck and Below Excl. PSC Series)	5 YEARS	YES	YES	YES	YES	90 DAYS	1, 2, 3, 5, 6 A, B, C, D, E
LSC SCALE (Deck and Below)	3 YEARS	YES	YES	YES	YES	90 DAYS	1, 2, 3, 5, 6, 11 A, B, C, D
GUARDIAN FLOOR SCALES	10 YEARS	YES	YES	YES	YES	NO	1, 2, 3, 5, 6, 9, 10 A, B, C, D
ALL OTHER CARDINAL PRODUCTS	1 YEAR	YES	YES	YES	YES	NO	1, 2, 5, 6 A, B, C, D, E
REPLACEMENT PARTS	90 DAYS	YES	YES	YES	YES	NO	1, 2, 4, 5, 6 A, B, C, D
SWIM AND 760 SERIES VEHICLE SCALES	1 YEAR	YES	YES	YES	YES	90 DAYS	1, 2, 5, 6 A, B, C, D
SOFTWARE	90 DAYS	YES	N/A	N/A	N/A	NO	1, 6 B, C, D
CONVEYOR BELT SCALES (including Belt-Way)	1 YEAR	YES	YES	YES	YES	NO	1, 2, 3, 5, 6 A, B, C, D, E, F



CARDINAL

Ph. (800) 441-4237
E-mail: cardinal@cardet.com
102 E. Daugherty
Webb City, MO 64870

04/24
Printed in USA
315-WARRANTY-CAR-M

APPLICABLE LIMITATIONS AND REQUIREMENTS

1. This warranty applies only to the original purchaser. The warranty does not apply to equipment that has been tampered with, defaced, damaged, or had repairs or modifications not authorized by Cardinal or has had the serial number altered, defaced or removed.
2. This warranty is not applicable to equipment that has not been grounded in accordance with Cardinal's recommendations.
3. This equipment must be installed and continuously maintained by an authorized Cardinal / Belt-Way dealer.
4. Applies only to components constructed from stainless steel.
5. This warranty does not apply to equipment damaged in transit. Claims for such damage must be made with the responsible freight carrier in accordance with freight carrier regulations.
6. Warranty term begins with date of shipment from Cardinal.
7. Only if device is rated NEMA 4 or better or IP equivalent.
8. Lifetime warranty applies to damages resulting from water, lightning, and voltage transients and applies only to the hydraulic load cell structure itself (does not include pressure transducers, rubber seals, o-rings, and associated wiring).
9. 10-Year prorated warranty on hydraulic load cells.
10. 1-Year warranty for scale structure.
11. PSC models' warranty coverage applies only to agricultural installations on farms up to 3,000 acres (LSC models not limited in this manner).
12. Load cell kits MUST be installed in accordance with Cardinal Scale instructions. Failure to follow these instructions will void the warranty.

EXCLUSIONS

- A.) This warranty does not include replacement of consumable or expendable parts. The warranty does not apply to any item that has been damaged due to unusual wear, abuse, improper line voltage, overloading, theft, fire, water, prolonged storage or exposure while in purchaser's possession or acts of God unless otherwise stated herein.
- B.) This warranty does not apply to peripheral equipment not manufactured by Cardinal. This equipment will normally be covered by the equipment manufacturer's warranty.
- C.) This warranty sets forth the extent of our liability for breach of any warranty or deficiency in connection with the sale or use of our product. Cardinal will not be liable for consequential damages of any nature, including but not limited to loss of profit, delays or expenses, whether based on tort or contract. Cardinal reserves the right to incorporate improvements in material and design without notice and is not obligated to incorporate said improvements in equipment previously manufactured.
- D.) This warranty is in lieu of all other warranties expressed or implied including any warranty that extends beyond the description of the product including any warranty of merchantability or fitness for a particular purpose. This warranty covers only those Cardinal products installed in the forty-eight contiguous United States and Canada.
- E.) This warranty does not cover paint coatings due to the variety of environmental conditions.
- F.) Do not cut load cell cables on load cells returned for credit or warranty replacement. Cutting the cable will void the warranty.
- G.) Software is warranted only for performance of the functions listed in the software manual and/or the Cardinal proposal.
- H.) The software warranty does not cover hardware. Warranties on hardware are provided from the hardware vendor only.
- I.) The software warranty does not cover interfacing issues to non-Cardinal supplied hardware.
- J.) The software warranty does not include automatic software upgrades unless purchased separately.



Ph. (800) 441-4237
E-mail: cardinal@cardet.com
102 E. Daugherty
Webb City, MO 64870

04/24
Printed in USA
315-WARRANTY-CAR-M

Cardinal Scale Mfg. Co.

102 E. Daugherty, Webb City, MO 64870 USA

Ph: 417-673-4631 or 1-800-641-2008

Fax: 417-673-2153

www.cardinalscale.com

Technical Support: 1-866-254-8261

E-mail: tech@cardet.com