

DETECTO®



DM15 Price Computing Scale Operation Manual

INTRODUCTION

Thank you for purchasing our DETECTO DM-15 Price Computing Scale. Your scale has been designed to operate from 115 VAC 50/60 Hz or with the included rechargeable battery pack.

This manual will guide you through the setup and operation of your scale. Please read it thoroughly before attempting to operate this scale and keep it handy for future reference.

FCC COMPLIANCE STATEMENT

This equipment generates uses and can radiate radio frequency and if not installed and used in accordance with the instruction manual, may cause interference to radio communications. It has been tested and found to comply with the limits for a Class A computing device pursuant to Subpart J of Part 15 of FCC rules, which are designed to provide reasonable protection against such interference when operated in a commercial environment. Operation of this equipment in a residential area may cause interference in which case the user will be responsible for taking whatever measures necessary to correct the interference.

You may find the booklet "How to Identify and Resolve Radio-TV Interference Problems" prepared by the Federal Communications Commission helpful. It is available from the U.S. Government Printing Office, Washington, D.C. 20402. Request stock No. 001-000-00315-4.

COPYRIGHT

All rights reserved. Reproduction or use, without express written permission, of editorial or pictorial content, in any manner, is prohibited. No patent liability is assumed with respect to the use of the information contained herein.

DISCLAIMER

While every precaution has been taken in the preparation of this manual, the Seller assumes no responsibility for errors or omissions. Neither is any liability assumed for damages resulting from the use of the information contained herein. All instructions and diagrams have been checked for accuracy and ease of application; however, success and safety in working with tools depend to a great extent upon individual accuracy, skill, and caution. For this reason, the Seller is not able to guarantee the result of any procedure contained herein. Nor can they assume responsibility for any damage to property or injury to persons occasioned from the procedures. Persons engaging in the procedures do so entirely at their own risk.

Serial Number _____
Date of Purchase _____
Purchased From _____

RETAIN THIS INFORMATION FOR FUTURE USE



PRECAUTIONS	
Before using this instrument, read this manual and pay special attention to all "WARNING" symbols:	
	IMPORTANT
	ELECTRICAL WARNING

TABLE OF CONTENTS

SPECIFICATIONS	1
INSTALLATION	2
Unpacking	2
Placement	2
Level Adjustment	2
Power Connection	2
Printer Connection	2
ANNUNCIATORS	3
KEY FUNCTIONS	4
OPERATION	5
Power Switch	5
Weight Display	5
Standard Unit Price Computation	5
Pre-Pack Operation	5
Tare Operation	6
Sample Labels	6
PRICE LOOK UP (PLU) OPERATION	7
SCALE SETTINGS	8
ERROR AND STATUS DISPLAYS	9
BEFORE YOU CALL SERVICE	9
CARE AND CLEANING	9

SPECIFICATIONS

Display:	0.5" High Seven-Segment LCD with backlight Weight = 6 Digits Unit Weight = 6 Digits Total Price = 6 Digits
Dimensions:	13.39" W x 13.39" D x 5.00" H (340 mm x 340 mm x 127 mm)
Platform Size	12.60" W x 9.06" D (320 mm x 230 mm)
Capacity and Division Value	240 oz x 0.1oz / 15 lb x .005 lb
Zero	Established on power up routine and maintained by auto-zero circuitry
Power	12 VDC 1.0 A Rechargeable battery pack or AC Adapter 110/120 VAC 50/60Hz
Tare	100% of full scale capacity
Operating Temperature	14° ~ 104°F (-10° ~ 40°C)
Interface:	RS-232 Serial Port, 9-Pin (DB-9), Baud Rate 9600

INSTALLATION

Unpacking

Before beginning installation of your DM15 Price Computing Scale, make certain the instrument has been received in good condition. Carefully remove the instrument from the shipping carton and inspect it for any evidence of damage (such as exterior dents or scratches) that may have taken place during shipment. Keep the carton and packing material for return shipment if it should become necessary. It is the responsibility of the purchaser to file all claims for any damages or loss incurred during transit.

Placement

Place the scale in an environment free of excessive dust and moisture and on a stable, vibration-free level surface away from direct sunlight and any rapidly moving air source (heating/cooling vents, fans, etc.). This will prevent sudden temperature changes and air currents that may result in unstable weight readings. Keep the area around the scale clear to provide adequate air circulation and make certain the power cord is routed out of the way of normal traffic.



CAUTION! DO NOT place the scale on an unstable cart, stand, or table. The scale may fall causing injury to the operator, and seriously damaging the unit, or proper operation of the scale may be inhibited.

Level Adjustment

Check to make certain the scale is level. The level indicator is located at the front of the scale. If the scale is not level (the bubble will not be centered), loosen the locking ring on all four (4) mounting feet and adjust them as required to center the bubble and attain a level scale. Once the scale is level, lock the mounting feet in place by tightening the adjustment locking rings against the bottom of the scale.

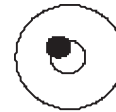

Not Levelled



Levelled

Power Connection

The scale uses an external AC power adapter that converts the 110/120 VAC 50/60Hz wall supply to the 12VDC power required by the scale. The scale also has circuitry necessary to monitor and recharge the battery and is capable of operating the scale and recharging the battery simultaneously.



NOTE: In areas subject to lightning strikes, additional protection (surge suppressors) should be installed.

Printer Connection

1. Attach the RS232 cable to the port at the rear of the printer.
2. Attach the power cable from the printer AC adapter to the jack at the rear of the printer.
3. Attach the RS232 cable to the port on the underside of the scale.
4. Attached power cable of the scale to the jack on the underside of the scale.
5. Plug both AC adapter power supplies into the power outlet.
6. Turn the scale on – power switch on the underside of the right side of the scale.
7. Turn the printer on – power switch at the rear of the printer.

ANNUNCIATORS

Annunciators indicate the active mode or functions of the scale. The meaning of each annunciator is described below.

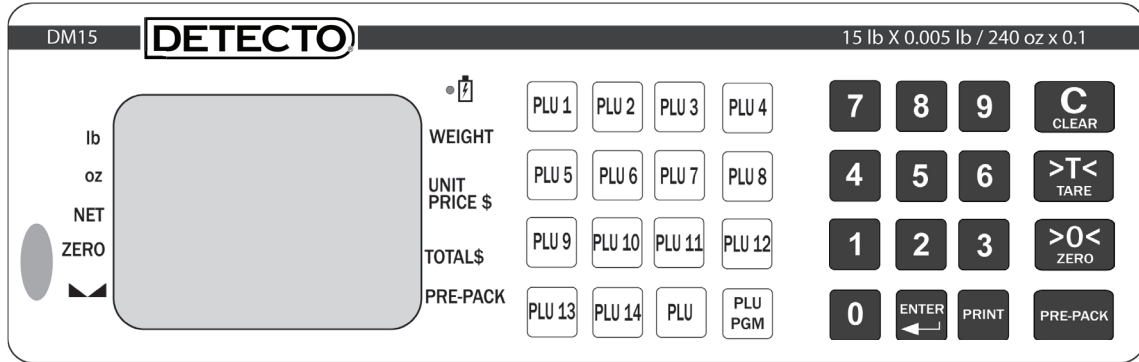

Front - Operator Keypad and Display

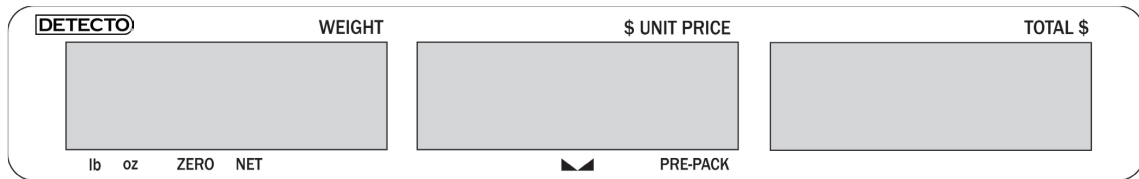

Rear - Customer Display

ZERO

The ZERO annunciator is located to the left of the display and is selected to indicate that the gross scale weight is zero.

NET

The NET annunciator is located to the left of the display and indicates the displayed weight is the net weight. Net weight is determined by subtracting the tare weight from the gross or scale weight. The tare weight, usually the weight of the container, is entered using the tare key. Note that the NET annunciator is only active when a zero tare weight or tare weight value is stored and the display is in the weight mode.

kg

The kg annunciator indicates the weight displayed is in kilograms and the UNIT PRICE is per kilogram.

lb

The lb annunciator indicates weight displayed is in pounds and the UNIT PRICE is per pound.

PRE-PACK

Indicates the scale is in the PRE-PACK mode. The PRE-PACK mode is used for repetitive price computing.



Indicates weight on the scale is stable



Red Light indicates the battery is charging.
Green Light indicates the battery is fully charged.

KEY FUNCTIONS

This section describes the use of each of the keys on the DM15 Price Computing Scale. It will be helpful to refer to the scale keyboard or the figure above when reading this section.



Clears unit price
Exits PLU and clears Tare



Set the weight display to zero and turn on the ZERO annunciator.
Also used in User Setup mode to return to the previous step.



Stores the current gross weight as the new tare weight and changes scale to the net weight mode.



Retains the Unit Price and Tare for repetitive price computing.



Enter input



Print Label



Price Look Up for PLU 15-99



Program Price Look Up PLU 1-99



Price Look Up for PLU 1-14



Numeric keys 0-9



The membrane keypad is not to be operated with pointed objects (pencils, pens, fingernails, etc.). Damage to the keypad resulting from this practice will *NOT* be covered under warranty.

OPERATION

Power Switch

The Power Switch is located on the bottom right side panel towards the front of the scale. Place the power switch in the on position. The scale will perform a brief display test illuminating all display segments and annunciator LEDs to allow the operator to make a visual verification that the display is operational. After completion of the display test, the software version will be displayed, the weight display will show zero weight indicating the scale is ready for use.



Before using the scale, it should be “warmed up” (turned on and unloaded for approximately 15 to 20 minutes).

Weight Display

Displaying Weight

1. With the scale in the weigh mode [0.000] will be displayed on the Weight display and [0.00] will be displayed on the UNIT PRICE and TOTAL PRICE displays, place the item to be weighed on the scale platform.
2. The WEIGHT display will show the weight on the scale platform. NOTE: The UNIT PRICE and TOTAL PRICE displays will remain at [0.00].

Zero the Weight Display

1. Press the **ZERO** key.
2. The weight display will return to zero. The ZERO annunciator will illuminate, indicating a center-of-zero gross weight condition.

Standard Unit Price Computation

1. Place commodity on the scale.
2. Enter UNIT PRICE.
3. Read WEIGHT and TOTAL PRICE.
4. If a label printer is connected to the scale, press the **PRINT** key to print a label.
5. Remove commodity. Weight will return to zero and prices will be cleared.

Pre-Pack Operation

For repetitive price-computing of commodities with the same unit price.

1. Enter tare if so desired as outlined in **Tare Operation**. Tare entry will be retained in PRE-PACK mode.
2. Enter the unit price and press the **PRE-PACK** key. The PRE-PACK annunciator will illuminate.
3. Place commodities on the scale.
4. If a label printer is connected to the scale, press the **PRINT** key to print a label.
5. When the pre-packing operation is ended, press the **CLEAR** key to clear the unit price, turn off PRE-PACK mode, and clear Tare.

OPERATION, CONT.

Tare Operation

1. Place the empty container on the scale.
2. Press the **TARE** key.
3. The WEIGHT display will change to zero and the NET weight annunciator will illuminate.
4. Key in unit price.
5. Place the commodity in the container. The net weight of the commodity will be displayed.
6. Read net commodity weight and total price.
7. If a label printer is connected to the scale, press the **PRINT** key to print a label.
8. Remove the container and commodity from the scale.
9. The scale will return to zero and clear tare and unit price information.
10. Scale is ready for the next operation.

Sample Labels

Standard Unit Price:

Weight
 PLU#
 Unit Price
 Total Price

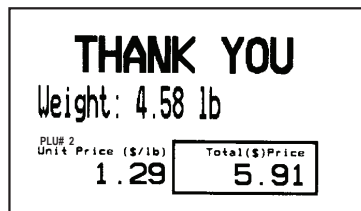

Unit Price with maximum digits:

Weight
 Unit Price
 Total Price

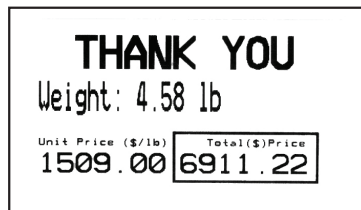

Total Price exceeds digit print capacity:

Weight
 Unit Price

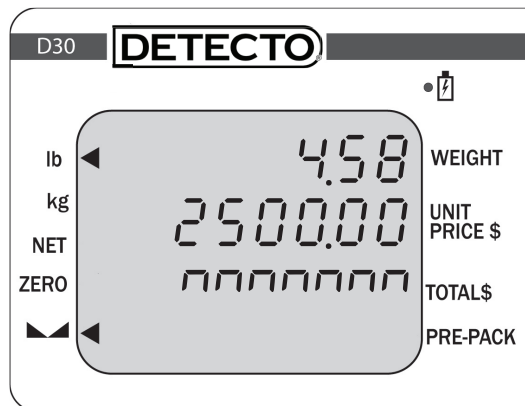
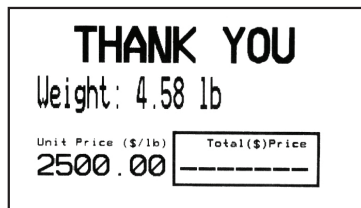

Scale display with Total Price digit capacity exceeded.

PRICE LOOK UP (PLU) OPERATION

PLU Programming

Programming PLU without a Tare Weight

1. Press the **PLU PGM** key
2. Press the PLU key (PLU1 – PLU14) or enter the PLU number (15-99) to program.
3. Press **ENTER**
4. Enter the UNIT PRICE and press **ENTER** twice.

Programming PLU with a Tare Weight

1. Press the **PLU PGM** key
2. Press the PLU key (PLU1 – PLU14) or enter the PLU number (15-99) to program.
3. Press **ENTER**
4. Enter the UNIT PRICE and press **ENTER**
5. Enter the known Tare weight or place the empty container on the scale and press **ENTER**.

PLU Operation

1. Press the key for the desired PLU (PLU1-PLU14 key or PLU key then number 15-99).
2. The PLU Unit Price will be displayed.
3. If a Tare weight is programmed for the selected PLU, the Weight displayed will be negative and the NET annunciator illuminated.
4. Place the commodity on the scale. Be sure to use the proper container if a Tare weight is programmed.
5. The Total Price will be displayed.
6. If a label printer is connected to the scale, press the **PRINT** key to print a label.
7. Remove the commodity, the scale will exit the PLU and return to zero weight.

Pre-Pack Operation with PLU

For repetitive price-computing of commodities with the same unit price.

1. Select the desired PLU as above.
2. Press the **PRE-PACK** key. The PRE-PACK annunciator will illuminate.
3. Place commodities on the scale.
4. If a label printer is connected to the scale, press the **PRINT** key to print a label.
5. Repeat until all commodities have been weighed.
6. When the pre-packing operation is ended, press the **CLEAR** key to turn off PRE-PACK mode and exit PLU.

SCALE SETTINGS

Access User setup with scale off, press and hold the **PRE-PACK** key while switching the scale on. The scale will display *SEtUP*. Use the following keys to navigate the settings shown below.

PRE-PACK ↓ Accept the displayed setting and proceed to the next step

TARE → Toggles available settings for the current step

ZERO ↑ Returns to the previous step

CLEAR Exits setup and proceeds to SAVE

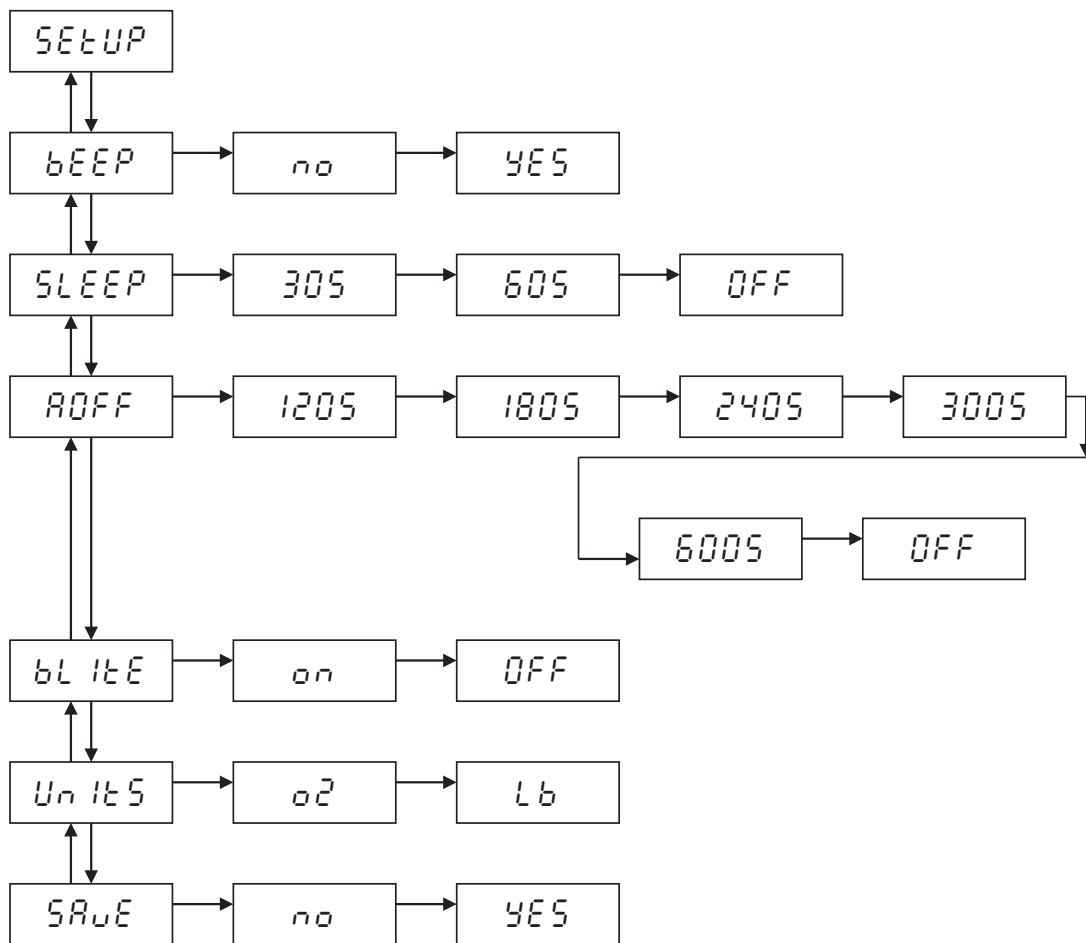

NOTE: No set-up is required for the Printer Port. It is pre-configured as OUTPUT only.

ERROR AND STATUS DISPLAYS

The DM15 Price Computing Scale is equipped with a diagnostic software program that tests various portions of the instrument's circuitry and verifies proper operation. Should a problem be detected, an error or status message will be displayed alerting the operator to that condition. The following lists these error messages and their meanings.

Display	Meaning
OCAP	Over Capacity - Indicates the scale weight capacity has been exceeded.
Lo bAt	Low Battery - Indicates the internal battery requires charging.
ErrE	E EPROM error
ErrH	Zero value too high
ErrL	Zero value too low
ErrS	Keypad error

BEFORE YOU CALL FOR SERVICE

Your DM15 Price Computing Scale has been designed to provide you with years of trouble-free operation. Despite this, troubles sometimes happen. Before calling for service assistance you should make some initial checks to verify that a problem does exist. The following describes several types of symptoms along with suggested remedies.

PROBLEM	POSSIBLE SOLUTIONS
The display does not turn on.	AC Operation: <ul style="list-style-type: none">• Is the AC power cord fully inserted into the wall receptacle?• Check the wall receptacle for proper AC power. Try another electrical appliance in the same receptacle. Does it work?• Check the circuit breaker.• Has there been a power failure Battery operation: <ul style="list-style-type: none">• Check if the battery is properly installed.• Is the battery discharged? Recharge or replace the battery.
Incorrect weight displayed	<ul style="list-style-type: none">• Ensure that the scale platform isn't touching an adjacent object.• Have proper operation procedures been followed?

CARE AND CLEANING

- **DO NOT** submerge the scale in water, pour or spray water directly on it.
- **DO NOT** use acetone, thinner, or other volatile solvents for cleaning.
- **DO** clean the indicator with a damp soft cloth and mild non-abrasive detergent.
- **DO** remove power before cleaning with a damp cloth.
- **DO** clean and store the scale in a plastic bag (in a dry environment) if the scale is not going to be used for some time. A desiccant packet may be included to prevent moisture buildup.
- **DO** recharge the internal battery every three months while in storage.

STATEMENT OF LIMITED WARRANTY

DETECTO warrants its equipment to be free from defects in material and workmanship as follows: DETECTO warrants to the original purchaser only that it will repair or replace any part of equipment which is defective in material or workmanship for a period of **two (2) years from date of shipment**. Detecto shall be the sole judge of what constitutes a defect.

During the **first ninety (90) days** DETECTO may choose to replace the product at no charge to the buyer upon inspection of the returned item.

After the first ninety (90) days, upon inspection of the returned item, DETECTO will repair or replace it with a remanufactured product. The customer is responsible for paying for the freight both ways.

This warranty does not apply to peripheral equipment not manufactured by DETECTO; this equipment will be covered by certain manufacturer's warranty only.

This warranty does not include replacement of expendable or consumable parts. This does not apply to any item which has deteriorated or damaged due to wear, accident, misuse, abuse, improper line voltage, overloading, theft, lightning, fire, water or acts of God, or due to extended storage or exposure while in purchaser's possession. This warranty does not apply to maintenance service. Purchased parts will have a ninety (90) day repair or replacement warranty only.

DETECTO may require the product to be returned to the factory; item(s) must be properly packed and shipping charges prepaid. A return authorization number must be obtained for all returns and marked on the outside of all returned packages. DETECTO accepts no responsibility for items lost or damaged in transit.

Conditions Which Void Limited Warranty

This warranty shall not apply to equipment which:

- A.) Has been tampered with, defaced, mishandled or has had repairs and modifications not authorized by DETECTO.
- B.) Has had serial number altered, defaced, or removed.
- C.) Has not been properly grounded according to Detecto's recommended procedure.

Freight Carrier Damage

Claims for equipment damaged in transit must be referred to the freight carrier in accordance with freight carrier regulations.

This warranty sets forth the extent of our liability for breach of any warranty or deficiency in connection with the sale or use of the product. DETECTO will not be liable for consequential damages of any nature, including but not limited to, loss of profit, delays or expenses, whether based on tort or contract. Detecto reserves the right to incorporate improvements in material and design without notice and is not obligated to incorporate improvements in equipment previously manufactured.

The foregoing is in lieu of all other warranties, express or implied including any warranty that extends beyond the description of the product including any warranty of merchantability or fitness for a particular purpose. This warranty covers only those DETECTO products installed in the forty-eight (48) contiguous continental United States.



Ph. (800) 641-2008
E-mail: detecto@cardet.com
102 E. Daugherty
Webb City, MO 64870

04/22/2024
Printed in USA
D268-WARRANTY-DET-B



DETECTO
102 E. Daugherty, Webb City, MO 64870 USA
Ph: 417-673-4631 or 1-800-641-2008
Fax: 417-673-2153
www.Detecto.com
Technical Support: 1-866-254-8261
E-mail: tech@cardet.com