



MedVue[®]



**Model MV1
Medical Weight Analyzer
Owner's Manual**

INTRODUCTION

Thank you for purchasing our MedVue® Model MV1 Medical Weight Analyzer. It has been manufactured with quality and reliability and has been tested before leaving our factory to ensure accuracy and dependability for years to come.

This manual is provided to guide you through the installation, operation, and maintenance of the MedVue Model MV1 Medical Weight Analyzer. Please read it thoroughly before attempting to install or operate the MV1 and keep it handy for future reference.

COPYRIGHT

All rights reserved. Reproduction or use, without express written permission, of editorial or pictorial content, in any manner, is prohibited. No patent liability is assumed with respect to the use of the information contained herein.

DISCLAIMER

While every precaution has been taken in the preparation of this manual, the Seller assumes no responsibility for errors or omissions. Neither is any liability assumed for damages resulting from the use of the information contained herein. All instructions and diagrams have been checked for accuracy and ease of application; however, success and safety in working with tools depend to a great extent upon individual accuracy, skill, and caution. For this reason, the Seller is not able to guarantee the result of any procedure contained herein. Nor can they assume responsibility for any damage to property or injury to persons occasioned from the procedures. Persons engaging in the procedures do so entirely at their own risk.

Serial Number _____
Date of Purchase _____
Purchased From _____

RETAIN THIS INFORMATION FOR FUTURE USE

PRECAUTIONS

Before using the weight analyzer, read this manual and pay special attention to all "NOTIFICATION" symbols:



IMPORTANT



**ELECTRICAL
WARNING**



**STATIC
SENSITIVE**

FCC COMPLIANCE STATEMENT

This equipment generates, uses, and can radiate radio frequency, and if not installed and used in accordance with the instruction manual, may cause interference to radio communications. It has been designed within the limits for a Class A computing device pursuant to Subpart J of Part 15 of FCC rules to provide reasonable protection against such interference when operated in a commercial environment. Operation of this equipment in a residential area may cause interference in which case the user will be responsible to take whatever measures necessary to correct the interference.

You may find the booklet "How to Identify and Resolve Radio-TV Interference Problems" prepared by the Federal Communications Commission helpful. It is available from the U.S. Government Printing Office, Washington, D.C. 20402. Request stock No. 001-000-00315-4.

PROPER DISPOSAL

When this device reaches the end of its useful life, it must be properly disposed of. It must not be disposed of as unsorted municipal waste. Within the European Union, this device should be returned to the distributor from where it was purchased for proper disposal. This is in accordance with EU Directive 2002/96/EC. Within North America, the device should be disposed of in accordance with the local laws regarding the disposal of waste electrical and electronic equipment.

It is everyone's responsibility to help maintain the environment and to reduce the effects of hazardous substances contained in electrical and electronic equipment on human health. Please do your part by making certain that this device is properly disposed of. The symbol shown to the right indicates that this device must not be disposed of in unsorted municipal waste programs.



CAUTION



CAUTION: RISK OF EXPLOSION IF BATTERY IS REPLACED BY AN INCORRECT TYPE. DISPOSE OF USED BATTERIES ACCORDING TO THE INSTRUCTIONS.

ATTENTION: RISQUE D'EXPLOSION SI LA BATTERIES EST REMPLAC'E PAR UN TYPE INCORRECT. REJETEZ LES BATTERIES UTILISE'ES SELON LES INSTRUCTIONS.

TABLE OF CONTENTS

SPECIFICATIONS	Page 1
Standard Features	Page 1
Optional Features	Page 1
SITE PREPARATION REQUIREMENTS	Page 2
INSTALLATION	Page 3
Unpacking	Page 3
Mounting	Page 4
Interconnections	Page 5
Optional AC Power Adapter	Page 5
Height Rod Option – Detecto DHR	Page 5
Load Cell	Page 5
USB	Page 5
USB, Serial, Ethernet, and Bluetooth/Wi-Fi Interface Specifications	Page 5
Serial I/O Port	Page 6
Bluetooth/Wi-Fi (Optional)	Page 6
Ethernet (Optional)	Page 6
BATTERIES	Page 7
Battery Status Symbol	Page 7
Low Battery Indicator	Page 7
Battery Installation/Replacement	Page 8
WEIGHING UNITS SELECTION	Page 9
KEYPAD FUNCTIONS	Page 10
Basic Functions	Page 10
Body Mass Index Functions	Page 11
nControl Feature	Page 12
ANNUNCIATORS	Page 13
OPERATION	Page 15
Basic Operation	Page 15
Tare Storage and Recall	Page 17
Basic Operation with ID	Page 18
Body Mass Index (BMI) Operation	
(Using Mechanical Height Rod or Entering Known Height)	Page 20
Body Mass Index (BMI) Operation with ID	
(Using Mechanical Height Rod or Entering Known Height)	Page 20
Body Mass Index (BMI) Operation with DHR	
(Using Digital Height Rod)	Page 21
Body Mass Index (BMI) Operation with ID and DHR	
(Using Digital Height Rod)	Page 22
CALIBRATION SETUP (Protected Setup Parameters)	Page 23
CALIBRATION SETUP (Non-Protected Setup Parameters)	Page 33
SETUP REVIEW	Page 41
WEIGHT ON DEMAND FORMATS	Page 43
SERIAL AND USB DEVICE PORT COMMANDS	Page 44
ERROR AND STATUS DISPLAYS	Page 47
BEFORE YOU CALL SERVICE	Page 47
CARE AND CLEANING	Page 48
SECURITY SEAL INSTALLATION	Page 49
PARTS IDENTIFICATION	Page 50
APPENDIX A (Top Plate Mounting Configurations)	Page 52
APPENDIX B (Connecting to a Welch Allyn CVSM Device)	Page 54

SPECIFICATIONS

Power Requirements	6 “C” cell Alkaline, Ni-Cad or NiMH batteries (<i>not included</i>) OR an optional 110-240 VAC 50/60 Hz 12 VDC 1.25A wall plug-in AC power adapter (Cardinal part number MV1PWR).
Operating Temperature	14 to 104 °F (-10 to +40 °C)
Display	Weight: 5-digit, seven segments, 7/8” (22.23 mm) high LCD Height: 4-digit, seven segments, 1/2” (12.7 mm) high LCD BMI: 3-digit, seven segments, 1/2” (12.7 mm) high LCD ID: 14-digit, 14 segments, .35” (8.89 mm) high LCD
Sensitivity	0.5 uV/division (0 to 3.0 mV/V), Class III
Signal Input Range	0 to 15mV max.
Transducer Excitation	5.0 VDC
Number of Load Cells	up to 4 each 350Ω
Load Cell Cable Length	30 feet (9 meters) max.
Resolution	10,000 divisions
Capacities	10,000 divisions commercial
NTEP	Certificate of Conformance Number 13-011
Division Value	1, 2, or 5 x 1, 0.1, 0.01, 0.001
Sample Rate	1 to 100 samples per second selectable
Auto Zero Range	0.5 or 1 through 9 divisions
Weighing Units	Pounds (lb) or Kilograms (kg)
Keyboard	Membrane type with 19 keys
Enclosure Size	9.8 in W x 6.8 in H x 1.8 in D (248.9 mm W x 172.7 mm H x 45.7 mm D)
Construction	Painted Steel
Battery Life:	7,560 weighments (with backlight fully ON) 10,620 weighments (with backlight fully OFF)
LCD Viewing Range:	Up to 30 feet / 10 meters for weight digits

Standard Features:

- Units Locking
- Auto Shut-Off Feature (Battery Operation)
- Selectable Sleep-Mode
- StableSENSE^{®1} Adjustable Filtering
- 14-Digit Alphanumeric Patient ID
- 99 Stored Tare Weights
- 200 Stored Transactions
- Serial I/O (Input/Output)
- USB Device Port
- Height Rod Port (for Optional Detecto Digital Height Rod)
- 1LOOK display, and four different languages available in set-up (English, Spanish, French, and German).

Optional Features:

- Wi-Fi and Bluetooth, available in Model MV1C
- MVIP, Wired Ethernet Interface
- Detecto DHR (Digital Height Rod)
- MV1PWR Medical Grade Power Supply with US Plug
- WACONNECT, Welch Allyn[®] Interface

¹ StableSENSE[®] is a digital filter utilizing a proprietary software algorithm that removes or greatly reduces changes in the weight display resulting from movement on the scale platform. When used with clinical scales, it will lessen the effects of the patient’s movement or vibration on the scale.

SITE PREPARATION REQUIREMENTS

The MedVue Model MV1 Medical Weight Analyzer is a precision weight indicating instrument. As with any precision instrument, it requires an acceptable environment to operate at peak performance and reliability. This section is provided to assist you in obtaining such an environment.

Environmental

The MedVue Model MV1 Medical Weight Analyzer meets or exceeds all certification requirements within a temperature range of 14 to 104 °F (-10 to +40 °C).

To keep cooling requirements to a minimum, the MV1 should be placed out of direct sunlight and to provide adequate air circulation, keep the area around the MV1 clear.



Do not place the MV1 directly in front of a heating or cooling vent. Such a location will subject it to sudden temperature changes, which may result in unstable weight readings.



Make sure the MV1 has good, clean AC power and is properly grounded. In areas subject to lightning strikes, additional protection to minimize lightning damage, such as surge suppressors, should be installed.



Electrical Power

The MedVue Model MV1 Medical Weight Analyzer has been designed to operate from a 110 to 240 VAC 50/60Hz 12 VDC 1.25A wall plug-in UL/CSA listed AC power adapter. Note that a special order is not required for operation at 240 VAC.

- The socket-outlet supplying power to the MV1 should be on a separate circuit from the distribution panel and dedicated to the exclusive use of the MV1.
- The socket-outlet shall be installed near the equipment and shall be easily accessible.
- The wiring should conform to national and local electrical codes and ordinances and should be approved by the local inspector to assure compliance.
- On installations requiring 240 VAC power, **it is the responsibility of the customer** to have a qualified electrician install the proper power adapter plug that conforms to national electrical codes and local codes and ordinances.

INSTALLATION

Unpacking

Carefully remove the MedVue Model MV1 Medical Weight Analyzer from the shipping carton and inspect it for any damage that may have taken place during shipment. You should keep the carton and packing material for return shipment if it should become necessary. The purchaser is responsible for filing all claims for any damages or loss incurred during transit.

Should your MedVue Model MV1 Medical Weight Analyzer come already installed on a scale, the following installation information does not apply to you.



Figure No. 1

INSTALLATION, CONT.

Mounting

The MedVue Model MV1 Medical Weight Analyzer is mounted to the scale (or an optional desktop/wall bracket) using a swivel ball and socket assembly.

To install the MV1 Rubber Ball into the Swivel Ball Socket, slightly loosen the Adjustment Knob to allow the two parts of the socket to open enough to insert the Rubber Ball. Adjust the MV1 to the desired viewing angle and direction and then tighten the Adjustment Knob.

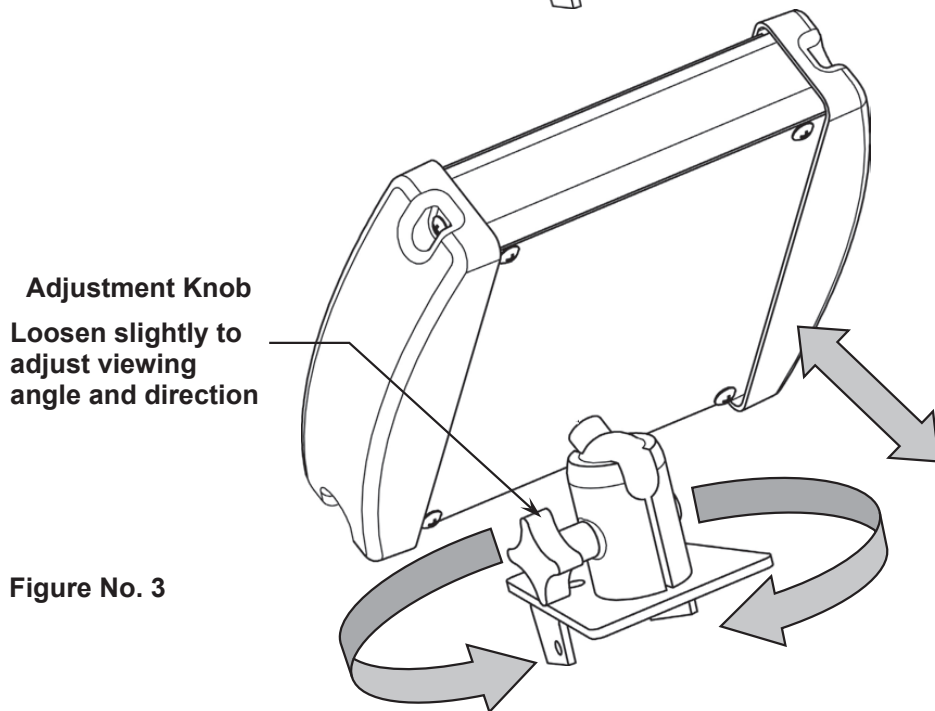
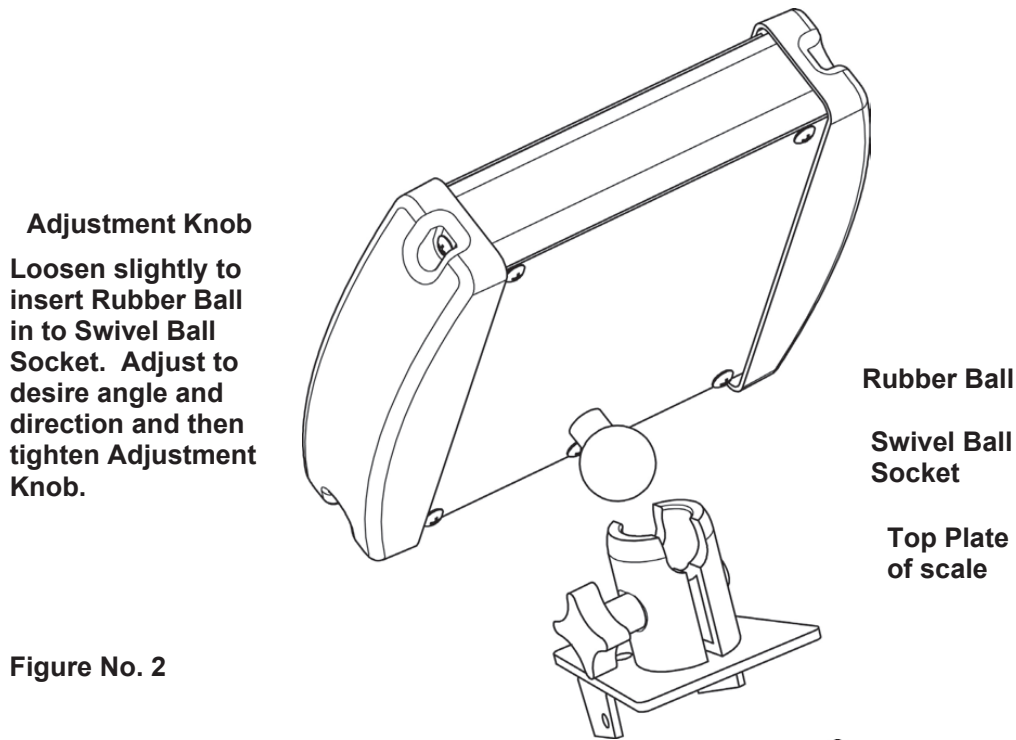

NOTE: The top plate mounting configuration varies depending on the model of your scale and may be different than the one shown in Figures No. 2 and 3. Refer to Appendix A for the various top plate mounting configurations.

INSTALLATION, CONT.

Interconnections

All input, output, power, and option connections to the MV1 are made on the rear panel. Connections for the Load Cell input and the Serial I/O are made using 9-pin "D" shaped connectors. The Height Rod option (Detecto DHR, Digital Height Rod) and Ethernet (MVIP) options use snap-in modular connectors. The USB port is a device (or upstream) port using an industry-standard "B" connector. The optional 12VDC wall plug-in UL/CSA listed AC power adapter is connected using a power jack. Refer to Figure No. 1.

Optional AC Power Adapter

To power the MV1 using the optional 12VDC wall plug-in AC power adapter, connect the plug from the adapter to the power jack on the back of the MV1, and then plug the power adapter into the proper electrical outlet. Refer to Figure No. 1. On models requiring 240 VAC, it is the customer's responsibility to obtain the correct power adapter plug.

Height Rod – Detecto DHR (Digital Height Rod) Option

The optional Detecto DHR (Digital Height Rod) connects to the MV1 by a snap-in modular connector socket. Insert the modular connector of the DHR cable into the socket on the rear of the MV1 it locks in place (a clicking sound will be heard when it is locked in place).

Load Cell

The load cell cable connects to the MV1 via a 9-pin "D" connector on the rear panel of the MV1. Figure No. 4 shows the pin identification for the load cell connector. Make certain that the pins are correctly identified before soldering a wire to them. Use the connector retaining screws to hold the load cell cable connector securely to the rear panel.

PIN NO.	FUNCTION
1	+ EXCITATION
2	- SIGNAL
5	SHIELD
6	- EXCITATION
7	+ SIGNAL

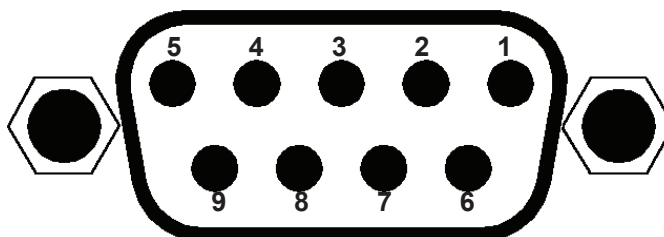

Figure No. 4

NOTE: Pins 3, 4, 8, and 9 are not used.

MATING CONNECTOR INFORMATION		
DESCRIPTION	ITEM	CARDINAL PART #
CONNECTOR	DE9-P	6610-2379
CONNECTOR SHELL	C883010001	6610-1131

USB

The USB port on the MV1 is a device (or upstream) port and uses readily available cables with the industry standard "B" connector.

USB, Serial, Ethernet, and Bluetooth/Wi-Fi Interface Specifications

The USB, Serial, optional Ethernet interface, and Bluetooth/Wi-Fi on the Model MV1C can be configured during the setup and calibration procedure or the setup review operation. Using either method, it is possible to select the operation of the interfaces.

The interfaces may be connected to a computer for transmission of weight and associated data to a PC-based EMR (electronic medical record) software program. The data can be transmitted on demand by pressing the **PRINT** key or on receipt of a command from the computer.

INSTALLATION, CONT.

Serial I/O Port

The serial I/O port is a 9-pin "D" connector on the rear panel of the MV1. Figure No. 5 shows the Serial I/O connector along with the identity of the pins used. Make certain that the pins are correctly identified before soldering a wire to them. Use the connector retaining screws to hold the serial cable connector securely to the rear panel.

PIN NO.	FUNCTION
2	DATA INPUT (RXD)
3	DATA OUTPUT (TXD)
5	SIGNAL GROUND (GND)
9	VCC or 5VDC

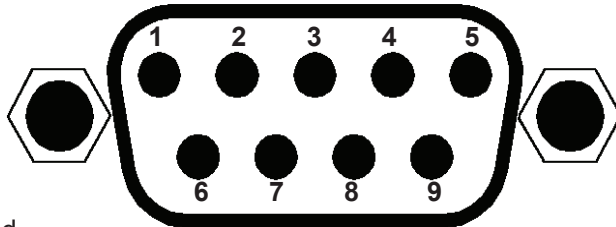

NOTE: Pins 1, 4, 6, 7, and 8 are not used.

Figure No. 5

The MV1 serial interface can be configured during the setup and calibration procedure or the setup review operation. Using either method, it is possible to select the operation of the serial interface as well as select the baud rate.

- The baud rates supported are 2400, 4800, 9600, 14.4k, 19.2K, 28.8K, 38.4K, 56K, 57.6K, and 115.2K baud.
- The data format is fixed at 8 bits, with No parity, and 1 stop bit.

NOTE: The MV1 is shipped from the factory with the baud rate set to 9600 baud.

Bluetooth/Wi-Fi (Optional)

The optional Bluetooth/Wi-Fi requires the purchase of the MV1C Medical Weight Analyzer, which includes the Redbird Wireless Transmitter module. Consult your network administrator for instructions to connect the MV1C to your wireless network.

Ethernet (Optional)

The MVIP Ethernet option requires the purchase of the optional Ethernet Interface Option. Once installed, connections to the MV1 are by CAT 5 or equivalent cable. Consult your network administrator for the proper procedure to terminate and connect the cable.

INSTALLATION, CONT.

BATTERIES

The MV1 can use 6 "C" size Alkaline, Ni-Cad, or NiMH batteries (*not included*). You must first obtain and install batteries before operations can begin. Batteries are contained in a battery holder inside the MV1. Access is via a removable panel on the back of the MV1. Refer to Figure No. 1.



CAUTION! The MV1 can be operated from Alkaline, Ni-Cad, or NiMH batteries. All six (6) batteries must be of the same type. They must all be Alkaline, all Ni-Cad, or all NiMH. **DO NOT** mix Alkaline and Ni-Cad or NiMH batteries.



NOTE: The MV1 does not have a battery charging circuit. Should you wish to use Ni-Cad or NiMH batteries, they must be fully charged before installing them. When discharged, Ni-Cad or NiMH batteries must be removed and placed in an external charger to recharge.

Battery Status Symbol

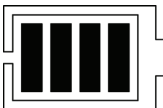

A battery status symbol will be displayed when batteries are installed. The number of bars indicates the level of charge remaining in the batteries.

4 Bars = 100%
3 Bars = 75%
2 Bars = 50%
1 Bar = 25%
No Bars = Low Battery

Low Battery Indicator

When the batteries are near the point they need to be replaced (Alkaline) or recharged (NiCad or NiMH), the battery status symbol will not show any bars. If the battery voltage drops too low for accurate weighing, the MV1 will automatically shut off and you will be unable to turn it back on.

Using Alkaline Batteries

When no bars are shown on the battery status symbol, press the **ON/OFF** key to turn the MV1 off, remove the old batteries and replace them with new ones.

Using NiCad or NiMH Batteries

When no bars are shown on the battery status symbol, press the **ON/OFF** key to turn the MV1 off, remove the discharged batteries, and replace them with fully charged ones. Place the discharged batteries in an external charger to recharge.

INSTALLATION, CONT.

Battery Installation/Replacement

To install or remove the batteries, the following steps should be followed:

1. Make sure the AC power adapter is unplugged.
2. Remove the MV1 from the mounting bracket and turn it over so that the display is facing away from you.
3. Locate the rectangular panel on the back of the MV1 and remove the thumb screw. Refer to Figure No. 1.
4. Remove the panel (lift straight up and slide it out) exposing the battery holder.
5. If installing new batteries, proceed to step 6. If replacing the batteries, remove all 6 batteries from the battery holder and then proceed to step 6.
6. Install the new 6 "C" size batteries in the holder, noting the polarity markings located in the battery holder. Refer to Figure No. 6.
7. After placing all 6 batteries in the holder, replace the panel on the back of the MV1 (slide the tab into the slot on the rear panel) and install the thumb screw.
8. Turn the MV1 over (display facing up), and then press the **ON/OFF** key.
9. If the display turns on, the batteries have been installed correctly. If not, remove the panel and check for one or more improperly positioned batteries.
10. Return the MV1 to the mounting bracket.
11. The MV1 is now ready for operation.

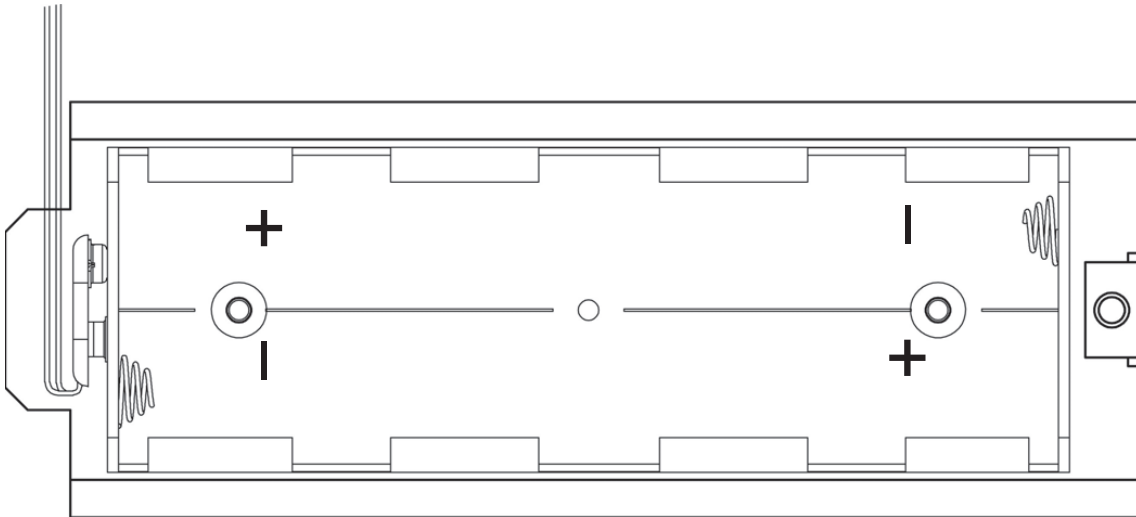



Figure No. 6

WEIGHING UNITS SELECTION

When the MedVue is turned on for the *first* time, it will display a prompt to select the weighing units to use for your operation, lb (pounds) or kg (kilograms). The weighing units selection can **ONLY** be made at this time and cannot be changed afterward. Make sure you select the correct weighing units before proceeding.



IMPORTANT! Make sure you select the correct weighing units. Once the weighing units has been set, it cannot be changed.



Key Legend



ON/OFF Key

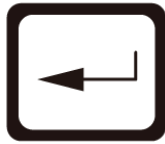

ENTER Key

1. Press the **ON/OFF** key to turn the MedVue on.
2. The display will show the software version for a few seconds, and then change to show **UNITS** (in small letters at the bottom left), and a large **l** at the top right, with the lb (pounds) annunciator flashing next to it.
3. If weighing in lb (pounds) is required for your operation, press the **ENTER** key to save it, and then proceed to step 7.
4. Otherwise, if your operation requires weighing in kg (kilograms), press the **3** key.
5. The display will change to show a large **Ξ** at the top right of the display and will flash the kg (kilograms) annunciator next to the large **Ξ**.
Note that **UNITS** will still be showing in smaller letters at the bottom left of the display.
6. Press the **ENTER** key to save the kg (kilograms) weighing units setting.
7. The scale is now ready for operation.

KEYPAD FUNCTIONS



DO NOT operate the keypad with pointed objects (pencils, pens, etc.). Damage to the keypad resulting from this practice is NOT covered under the warranty.

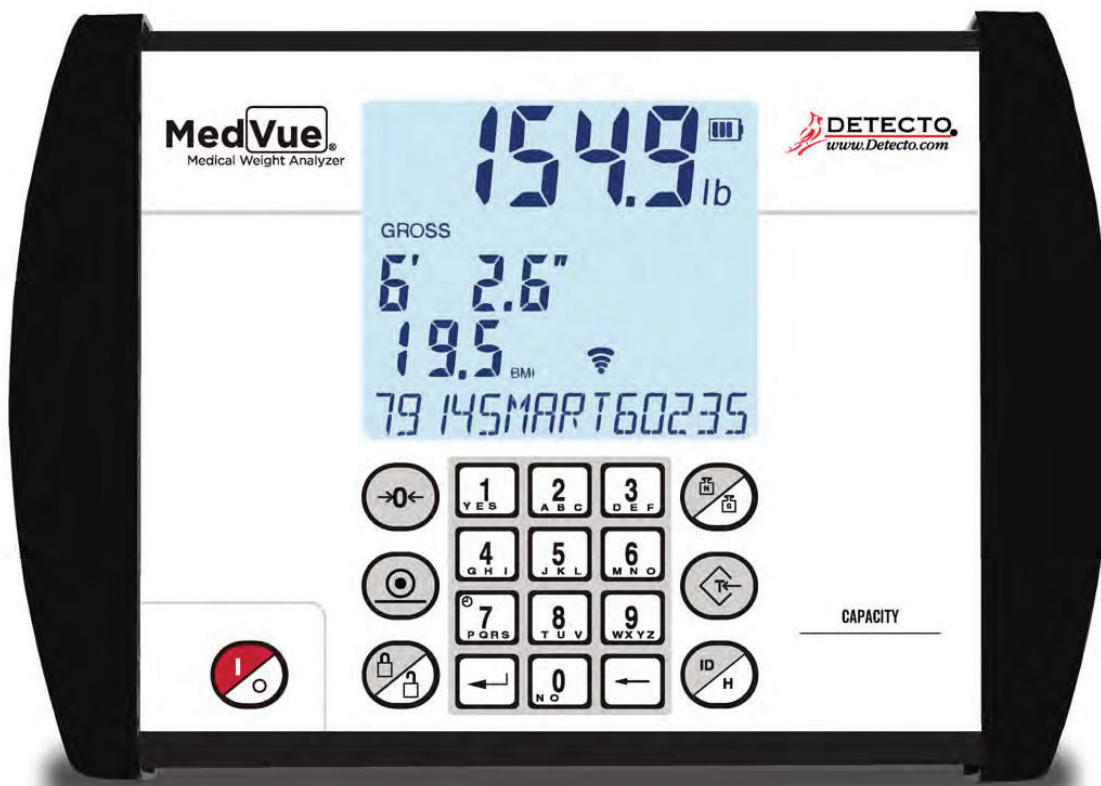

Figure No. 7



This is the **ON/OFF** key. With the MV1 off, pressing this key will turn it on. If the MV1 is already on, pressing the key will turn it off.

Basic Functions



This is the **ZERO** key. It is used to reset the display to zero up to the selected limit of either 4% or 100% of the scale capacity. The zero limit is set during the setup and calibration of the MV1.

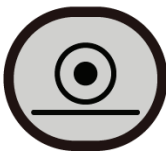

This is the **PRINT** key. It is used to signal the completion of the data entry, process the data entered, and send the weight and associated data to the USB port, RS232 serial port, the optional Ethernet port, and the optional Wi-Fi and Bluetooth.



NOTE: The MV1 will not respond to pressing the **PRINT** key unless the weight display is stable. If displaying gross weight, only the gross weight is printed. If displaying net weight, the gross, tare, and net weights are printed. If the ID and BMI features are used, their data is printed along with the weight data.

KEYPAD FUNCTIONS, CONT.

Basic Functions, Cont.



This is the **LOCK/RELEASE** key. It is used to lock and unlock the display. If the HOLD feature was enabled during setup and calibration, pressing this key (after obtaining a stable weight) will cause the MV1 to lock onto the weight. Pressing this key again will unlock the display and return it to zero.

If the AUTO LOCK feature was enabled, the weight display will lock after placing a load on the scale and obtaining a stable weight value. Pressing this key will unlock the display and return the weight display to zero, or if another load is applied to the scale, lock onto the new weight after obtaining a stable weight value. **NOTE:** The lock feature is for non-commercial (NOT "Legal for Trade") applications.

Body Mass Index (BMI) Functions

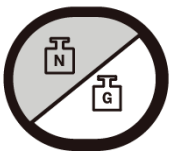

This is the **NET/GROSS** key. It is used to toggle between Net and Gross weight modes. The selected mode is indicated by turning on the appropriate annunciator on the display. Note that if no valid tare weight has been entered; pressing this key will cause (No Tare) to be shown in the 14-segment display.



This is the **TARE** key. It is a dual-function key. Pressing it, selecting a memory location, and pressing the **ENTER** key (Pushbutton Tare mode) will cause the current gross weight to be stored as the new tare weight. Pressing this key, entering a numeric weight value (Keypad Tare), selecting a memory location, and then pressing the **ENTER** key will cause the value entered to be stored as the new tare weight. Either method will change the weight display to the net weight display mode and turn on the Net annunciator.

Pushbutton Tare Function:

Press the **TARE** key and then the **ID/HEIGHT** key, input a number between 0 and 99, and then press the **ENTER** key to store the current Gross weight in a memory location as a recallable tare weight.

Keypad Tare Function:

Press the **TARE** key, input the weight value, press the **ID/HEIGHT** key, input a number between 0 and 99, and then press the **ENTER** key to store the entered value in a memory location as a recallable tare weight.



NOTE: Tare weights equal to or greater than scale capacity cannot be entered. In addition, the keypad tare weight division value must be the same as the scale division value. For example, a unit with .05 kg as the division value will display **WRONG GRd5** if you attempt to enter 1.03 for the tare weight.

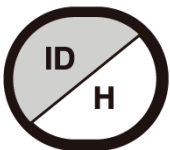

This is the **ID/HEIGHT** key. This key is used to display and enter an identification (ID) used in the ID Storage feature and to enter the height (feet and inches or centimeters) for the Body Mass Index (BMI) calculation.

Pressing this key will change the display to show the currently selected identification (ID) and allow the entry of a new ID. The identification (ID) can be up to 14 alphanumeric characters.

To recall the stored tare weight from the memory location, press the **ID/HEIGHT** key, input a number between 1 and 99, and then press the **TARE** key.

KEYPAD FUNCTIONS, CONT.

Standard Function Keys

The **0** through **9** keys are used to enter alphanumeric data during the setup and calibration as well as during the normal operation of the MV1.

To enter letters, you must press the key in succession until the desired letter is displayed. This is similar to the way early cell phone keypads operate. (Ex: If you want to enter the letter C, you will need to press the **2** key four times).



NOTE: The **0**, **1**, and **7** keys have dual functions. They are used to enter numeric data during setup and calibration as well as during normal operations. In addition, the **0** and **1** keys are used to select no (0 = NO) or yes (1 = YES) to various prompts.

The **7** key is used to activate the Sleep mode feature. Pressing and holding the **7** key for approximately 3 seconds will initiate the sleep mode to conserve power while the MV1 remains unused. Sleep Mode requires the MV1 to remain at a stable zero weight. When enabled, the display will show the date and time and the backlight will be turned off. Placing weight on the scale or pressing any key will activate the MV1 and return it to weight mode.



This is the **CLEAR (BACKSPACE)** key. It is used to clear an incorrect entry from the display without processing the data. If an incorrect entry is made, press this key, and re-enter the correct data. When entering the ID, pressing this key will act as a “backspace” key (it will back up one space and delete the character in that space). **NOTE:** The **CLEAR** key must be pressed before the **ENTER** key to ensure the data is not processed.



This is the **ENTER** key. It serves two purposes. First, during setup, pressing the **ENTER** key will accept the currently displayed setting of the parameter. Second, the **ENTER** key is used to signal the completion of data entry (in both setup and operation) and causes the scale to process the data entered.

nControl Feature

The MV1 includes support for *nControl*. *nControl* is a PC-based program that can design a ticket and then download the ticket information to the MV1. The MV1 allows 1 programmable format (up to 512 characters in size) instead of the ASCII format default ticket.

For more information on *nControl*, refer to the *nControl Fast Start Guide*.

NOTE: If the **ID/HEIGHT** key is disabled, the appropriate field will be left out when printing a ticket.

Time, mm/dd/yy	
ID:	xxxxxxxxxxx
BMI:	xx.x
Height:	xx.x cm
Weight:	xxx.xuu G
	xxx.xuu T
	xxx.xuu N

SAMPLE TICKET

ANNUNCIATORS

The annunciators are turned on to indicate that the display is in the mode corresponding to the annunciator label or that the status indicated by the label is active.

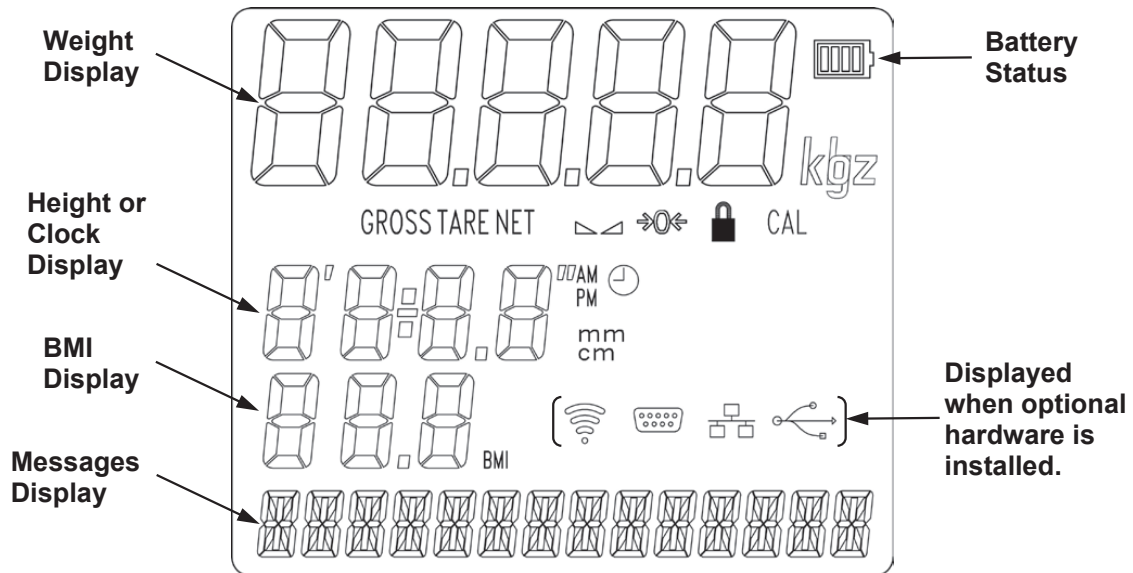

Figure No. 8

GROSS

The GROSS annunciator is turned on to show that the weight displayed is the gross weight. Gross weight will be displayed when no tare weight value is stored.

TARE

The TARE annunciator is turned on to show that the MV1 is in a weight mode in which a known tare (container) weight value is stored.

NET

The NET annunciator is turned on to show that the weight displayed is the net weight. Net weight is determined by subtracting the stored tare weight from the gross weight. The tare weight is usually the weight of the empty container. Note that the NET annunciator is only active when a tare weight value is stored.

▲▲ (STABLE)

The (▲▲) annunciator is turned on when the weight display is stable. When off, it means that the change in successive weight samples is greater than the motion limits selected during the setup and calibration of the MV1.

→0← (ZERO)

The (→0←) annunciator is turned on to indicate that the weight is within +/- 1/4 division of the center of zero.

🔒 (LOCK)

The (🔒) annunciator is turned on to show that the MV1 is locked onto the displayed weight. In operation after obtaining a stable weight value, pressing the **LOCK/RELEASE** key (or resetting the Auto Lock) will cause the MV1 to lock onto the weight and turn on the annunciator. Pressing the **LOCK/RELEASE** key a second time (or dropping below the Auto Lock reset value) will unlock the display and turn off the annunciator.

NOTE: The lock feature (Hold Mode) must be enabled during Calibration Setup.

ANNUNCIATORS, CONT.

CAL

The CAL annunciator will be turned on after pressing the calibration switch to show that the MV1 is in the Setup and Calibration mode.

lb

This annunciator is turned on to indicate that the displayed weight is in pounds.

kg

The kg annunciator is turned on to indicate that the displayed weight is in kilograms.

' "

The (') feet and (") inches annunciators are turned on when the displayed height measurement is in feet and inches.

cm

The cm annunciator is turned on to indicate that the displayed height measurement is in centimeters.

mm

The mm annunciator is turned on to indicate that the displayed height measurement is in millimeters.

AM

The AM annunciator is turned on to indicate that the displayed time is before noon.

PM

The PM annunciator is turned on to indicate that the displayed time is after noon.



The ⌚ annunciator is turned on to indicate that the displayed value is the time.

BMI (Body Mass Index)

The BMI annunciator is turned on when displaying the calculated body fat.



Wi-Fi

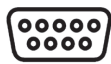

RS232

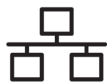

Ethernet

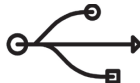

USB

NOTE: These annunciators are turned on when optional hardware is installed and in use.

OPERATION



ALWAYS assist the patient on and off the scale to ensure they do not fall. **NEVER** leave a patient unattended while they are on the scale. Failure to maintain control of the patient at all times can result in severe injury to the patient and/or you.

Basic Operation

To Weigh

1. Press the **ON/OFF** key to turn the MV1 on.
2. If required, press the **ZERO** key to zero weight display.
3. Assist patient onto the scale.
4. When the weight is stable (STABLE ) turns on), read weight display.
5. If a printer is connected to the scale, press the **PRINT** key to print a ticket.
6. Assist patient off the scale.

Zero Weight Display

1. In Gross Weight mode (GROSS annunciator on), press the **ZERO** key.
2. The weight display will return to zero. ZERO and STABLE  annunciators will turn on to show a stable, center-of-zero ($\rightarrow 0 \leftarrow$) gross weight condition.

Basic Tare Operation

Push Button Tare (Tare weight is NOT known)

NOTE: Tare entry is not allowed if Auto Hold is enabled.

1. In Gross Weight mode (GROSS annunciator on), place item (wheelchair, walker, etc.) on the scale.
2. Press the **TARE** key.
3. The Display will change to show ENTER TARE WT, the weight of the item on the scale, and the TARE annunciator will turn on.
4. Press the **ENTER** key.
5. The display will change to 0.0 and the NET annunciator will turn on to show that the net weight is being displayed. The item's weight has been entered as "tare weight".
6. Assist patient onto the scale.
7. When the weight is stable (STABLE ) turns on), read weight display.
8. If a printer is connected to the scale, press the **PRINT** key to print a ticket.
9. Assist patient off the scale.

To Clear the Tare Weight

1. Remove all material from the scale platform, and then press the **TARE** key.
2. Press the **ZERO** key.
3. This will clear the tare weight and return the MV1 to the Gross weight mode.

OPERATION, CONT.

Tare Weight Entry (Tare weight is known)

1. In Gross Weight mode (GROSS annunciator on), press the **TARE** key.
2. The Display will change to show ENTER TARE WT and the TARE annunciator will turn on.
3. Use the numeric keys and enter a tare weight. Note that when entering tare weights, a maximum of 4 digits can be entered and the numbers advance from right to left in the display. The number of leading or trailing zeros required to obtain your desired tare is dependent upon the DIVISION VALUE selected in the setup procedure.

For example, Division Value: 0.2 lb
 Desired Tare Value: 10.6 lb
 Key Sequence: 1 0 6

4. After the tare weight has been entered, press the **ENTER** key.
5. The display will show a minus Net weight and the NET annunciator will turn on.
6. Assist patient onto the scale.
7. When the weight is stable (STABLE ▲▼ annunciator turns on), read weight display.
8. If a printer is connected to the scale, press the **PRINT** key to print a ticket.
9. Assist patient off the scale.

Tare Weight Recall

1. In Net Weight mode (NET annunciator on), press the **TARE** key.
2. The Display will change to show ENTER TARE WT and the previously entered tare weight. Note that the TARE annunciator will turn on.
3. Press the **ENTER** key to return to Net Weight mode (NET annunciator on).

To Clear the Tare Weight

1. Remove all material from the scale platform, and then press the **TARE** key.
2. Press the **ZERO** key.
3. This will clear the tare weight and return the MV1 to the Gross weight mode.

OPERATION, CONT.

Tare Storage and Recall

NOTE: ID must be enabled to use stored Tare. Refer to SYSTEM Menu, Enable ID.

To Store Tare Weight

1. In Gross Weight mode (GROSS annunciator on), press the **TARE** key.
2. The Display will change to show ENTER TARE WT and the TARE annunciator will turn on.
3. Use the numeric keys and enter a tare weight. Note that when entering tare weights, a maximum of 4 digits can be entered and the numbers advance from right to left in the display. The number of leading or trailing zeros required to obtain your desired tare is dependent upon the DIVISION VALUE selected in the setup procedure.

For example,	Division Value:	0.2 lb
	Desired Tare Value:	10.6 lb
	Key Sequence:	1 0 6

4. After the tare weight has been entered, press the **ID/HEIGHT** key.
5. The display will change to show *id*.
6. Using numeric keys, enter the memory location (1 to 99).
7. Press the **ENTER** key.
8. The tare weight is now stored in memory and the display will show a minus Net weight and the NET annunciator will turn on.
9. Assist patient onto the scale.
10. When the weight is stable (STABLE  annunciator turns on), read weight display.
11. If a printer is connected to the scale, press the **PRINT** key to print a ticket.
12. Assist patient off the scale.

To Recall Tare Weight

1. Press the **ID/HEIGHT** key.
2. The display will change to show *id*.
3. Using numeric keys, enter the memory location (1 to 99).
4. Press the **TARE** key.
5. The display will change to show ENTER TARE WT and the previously entered tare weight. Note that the TARE annunciator will turn on.
6. If the tare weight displayed is acceptable, press the **ENTER** key to save it.
7. Otherwise, press the **ZERO** key to clear the tare weight and return the MV1 to the Gross weight mode.

OPERATION, CONT.

Basic Operation with ID

To Weigh

1. Press the **ON/OFF** key to turn the MV1 on.
2. If required, press the **ZERO** key to zero weight display.
3. Press the **ID/HEIGHT** key.
4. The display will change to show *Id*.
5. Using numeric keys, enter up to a 14-digit alphanumeric identification number.
6. Press the **ENTER** key.
7. Assist patient onto the scale.
8. When the weight is stable (STABLE ) annunciator turns on), read weight display.
9. If a printer is connected to the scale, press the **PRINT** key to print a ticket.
10. Assist patient off the scale.

Push Button Tare (Tare weight is NOT known)

NOTE: Tare entry is not allowed if Auto Hold is enabled.



1. In Gross Weight mode (GROSS annunciator on), place item (wheelchair, walker, etc.) on the scale.
2. Press the **TARE** key.
3. The display will show the weight of the item on the scale and the TARE annunciator will turn on.
4. Press the **ENTER** key.
5. The display will change to zero and the NET annunciator will turn on to show that the net weight is being displayed. The item's weight has been entered as "tare weight".
6. Press the **ID/HEIGHT** key.
7. The display will change to show *Id*.
8. Using numeric keys, enter up to a 14-digit alphanumeric identification number.
9. Press the **ENTER** key.
10. Assist patient onto the scale.
11. When the weight is stable (STABLE ) annunciator turns on), read weight display.
12. If a printer is connected to the scale, press the **PRINT** key to print a ticket.
13. Assist patient off the scale.

OPERATION, CONT.

Tare Weight Entry (Tare weight is known)

1. In Gross Weight mode (GROSS annunciator on), press the **TARE** key.
2. The display will change to show *0.0* or a previously entered tare and the TARE annunciator will turn on.
3. If the weight displayed is acceptable, press the **ENTER** key to save it. Otherwise, use the numeric keys and enter a new tare weight. Note that when entering tare weights, a maximum of 4 digits can be entered and the numbers advance from right to left in the display. The number of leading or trailing zeros required to obtain your desired tare is dependent upon the DIVISION VALUE selected in the setup procedure.

For example,	Division Value:	0.2 lb
	Desired Tare Value:	10.6 lb
	Key Sequence:	1 0 6

4. After the new tare weight has been entered, press the **ENTER** key.
5. The display will show a minus Net weight and the NET annunciator will turn on.
6. Press the **ID/HEIGHT** key.
7. The display will change to show *id*.
8. Using numeric keys, enter up to a 14-digit alpha numeric identification number.
9. Press the **ENTER** key.
10. Assist patient onto the scale.
11. When the weight is stable (STABLE   annunciator turns on), read weight display.
12. If a printer is connected to the scale, press the **PRINT** key to print a ticket.
13. Assist patient off the scale.

OPERATION, CONT.

Body Mass Index (BMI) Operation

Using a Mechanical Height Rod or Entering Known Height

1. Press the **ON/OFF** key to turn the MV1 on.
2. If required, press the **ZERO** key to zero weight display.
3. Perform tare operation if required. Refer to Push Button Tare or Tare Weight Entry in the previous section for instructions on using tare.
4. Press the **ID/HEIGHT** key.
5. If Centimeters was selected for HEIGHT UNITS in setup, the display will change to show CENTIMETERS.
 - a. Use numeric keys to enter up to 4 digits (# # # . #) for height in centimeters and then press the **ENTER** key.
6. If Millimeters was selected for HEIGHT UNITS in setup, the display will change to show MILLIMETERS.
 - a. Use numeric keys to enter up to 4 digits (# # # #) for height in millimeters and then press the **ENTER** key.
7. Assist patient onto the scale.
8. When the weight is stable (STABLE ) annunciator turns on), read weight, height, and BMI displays.
9. If a printer is connected to the scale, press the **PRINT** key to print a ticket. Note that the BMI and height display will clear when the ticket prints.
10. Assist patient off the scale.
11. If a printer is not connected to the scale, the BMI display will clear when the patient is assisted off the scale, and the weight returns to zero.

Body Mass Index (BMI) Operation with ID

Using a Mechanical Height Rod or Entering Known Height

1. Press the **ON/OFF** key to turn MV1 on.
2. If required, press the **ZERO** key to zero weight display.
3. Press the **ID/HEIGHT** key.
4. The display will change to show *id*.
5. Using numeric keys, enter up to a 14-digit alphanumeric identification number.
6. Press the **ENTER** key.
7. If Centimeters was selected for HEIGHT UNITS in setup, the display will change to show CENTIMETERS.
 - a. Use numeric keys to enter up to 4 digits (# # # . #) for height in centimeters and then press the **ENTER** key.
8. If Millimeters was selected for HEIGHT UNITS in setup, the display will change to show MILLIMETERS.
 - a. Use numeric keys to enter up to 4 digits (# # # #) for height in millimeters and then press the **ENTER** key.
9. Assist patient onto the scale.
10. When the weight is stable (STABLE ) annunciator turns on), read weight, height, and BMI displays.
11. If a printer is connected to the scale, press the **PRINT** key to print a ticket. Note that the BMI, ID, and height display will clear when the ticket prints.
12. Assist patient off the scale.
13. If a printer is not connected to the scale, the BMI display will clear when the patient is assisted off the scale, and the weight returns to zero.

OPERATION, CONT.

Body Mass Index (BMI) Operation with DHR

Using Digital Height Rod



IMPORTANT! Before performing the operations on this page, the digital height rod must be in its “starting position” (the inner sliding tube must be down completely inside the outer stationary tube and the headpiece folded flat against the stationary tube) before turning on the MV1.

1. Make sure the height rod is in the starting position.
2. Press the **ON/OFF** key to turn MV1 on.
3. If required, press the **ZERO** key to zero weight display. Note that the height reading will show 3' 7.3" or 110.0 cm (depending on the HEIGHT UNITS setting in Setup).
4. Perform tare operation if required. Refer to Push Button Tare or Tare Weight Entry in the previous section for instructions on using tare.



NOTE: If the patient is shorter than 3' 7.3" (110 cm) or taller than 6' 7.3" (201.2 cm), proceed to steps 5, 6, or 7 depending on the HEIGHT UNITS setting. Otherwise, press the **ENTER** key without entering a value for steps 5, 6, or 7 (twice for Step 5 and once for Steps 6 or 7) and proceed to Step 8.

5. Press the **ID/HEIGHT** key. If Centimeters was selected for HEIGHT UNITS in setup, the display will change to show CENTIMETERS.
 - a. Use numeric keys to enter up to 4 digits (# # # . #) for height in centimeters and then press the **ENTER** key.
6. Press the **ID/HEIGHT** key. If Millimeters was selected for HEIGHT UNITS in setup, the display will change to show MILLIMETERS.
 - a. Use numeric keys to enter up to 4 digits (# # # #) for height in millimeters and then press the **ENTER** key.
7. Assist patient onto the scale.
8. Grasp the height rod at the hinge pin (see Figure No. 9) and raise it well above the patient's head, and then lift the headpiece to the horizontal position. Carefully lower the height rod until the headpiece rests on the patient's head.
9. BMI will automatically be displayed with height.
10. When the weight is stable (STABLE  annunciator turns on), read weight, height, and BMI displays.
11. If a printer is connected to the scale, press the **PRINT** key to print a ticket.
12. While holding the headpiece horizontally, raise the height rod well above the patient's head.
13. Assist the patient off the scale and return the height rod to the starting position.
14. If a Tare operation was performed, press the **NET/GROSS** key to return to Gross weight mode.
15. Press the **ZERO** key. This will reset the tare weight to zero.
16. The BMI display will clear when the weight returns to zero.



Figure No. 9

OPERATION, CONT.

Body Mass Index (BMI) Operation with ID and DHR

Using Digital Height Rod



IMPORTANT! Before performing the operations on this page, the digital height rod must be in its “starting position” (the inner sliding tube must be down completely inside the outer stationary tube and the headpiece folded flat against the stationary tube) before turning on the MV1.

1. Make sure the height rod is in the starting position.
2. Press the **ON/OFF** key to turn MV1 on.
3. If required, press the **ZERO** key to zero weight display. Note that the height reading will show 3' 7.3" or 110.0 cm (depending on the HEIGHT UNITS setting in Setup).
4. Perform tare operation if required. Refer to Push Button Tare or Tare Weight Entry in the previous section for instructions on using tare.
5. Press the **ID/HEIGHT** key.
6. The display will change to show **Id=**.
7. Using numeric keys, enter up to a 14-digit alpha numeric identification number.
8. Press the **ENTER** key.



NOTE: If the patient is shorter than 3' 7.3" (110 cm) or taller than 6' 7.3" (201.2 cm), proceed to steps 9, 10, or 11 depending on the HEIGHT UNITS setting. Otherwise, press the **ENTER** key without entering a value for steps 9, 10, or 11 (twice for Step 9 and once for Steps 10 or 11) and proceed to Step 12.

9. If Centimeters was selected for HEIGHT UNITS in setup, the display will change to show **CENTIMETERS**.
 - a. Use numeric keys to enter up to 4 digits (###.#) for height in centimeters and then press the **ENTER** key.
10. If Millimeters was selected for HEIGHT UNITS in setup, the display will change to show **MILLIMETERS**.
 - a. Use numeric keys to enter up to 4 digits (####) for height in millimeters and then press the **ENTER** key.
11. Assist patient onto the scale.
12. Grasp the height rod at the hinge pin (see Figure No. 10) and raise it well above the patient's head, and then lift the headpiece to the horizontal position. Carefully lower the height rod until the headpiece rests on the patient's head.
13. BMI will automatically be displayed with height.
14. When the weight is stable (STABLE  annunciator turns on), read weight, height, and BMI displays.
15. If a printer is connected to the scale, press the **PRINT** key to print a ticket.
16. While holding the headpiece horizontally, raise the height rod well above the patient's head.
17. Assist patient off the scale and return height rod to starting position.
18. If a Tare operation was performed, press the **NET/GROSS** key to return to Gross weight mode.
19. Press the **ZERO** key. This will reset the tare weight to zero.
20. BMI display and ID will clear when the weight returns to zero.



Figure No. 10

CALIBRATION SETUP

(Protected Setup Parameters)

Your MedVue Model MV1 Medical Weight Analyzer has been thoroughly tested and calibrated before being shipped to you. If you received it with a scale, calibration is not necessary. If the MV1 is being connected to a scale for the first time or recalibration is necessary for other reasons, the following describes the steps to perform calibration setup on the MV1.

To Enter the Calibration Setup:

1. With the power off, remove the two (2) screws from the left end cap (as viewed from the front of the MV1) and remove the end cap.
2. Locate the calibration switch (access is through a hole in the side panel). See Figure No. 11.
3. Press the **ON/OFF** key to turn the MV1 on.
4. The MV1 will show the software version and then change to the Gross weight mode.
5. With the MV1 on, press and hold the calibration switch until the display changes to show:

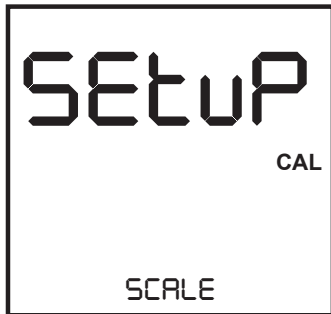

Figure No. 11

6. Release the calibration switch.
7. The MV1 is now ready for setup and calibration.

During setup and calibration, it is necessary to enter operational parameters via the MV1's keypad. The following keys and the numeric keypad are used to input the values.



NOTE: The membrane keypad is not to be operated with pointed objects (pencils, pens, fingernails, etc.). Damage to the keypad resulting from this practice will NOT be covered under the warranty.

Navigation Keys

The Navigation Keys are used to move around the menu selections during setup and calibration. They are used to select the parameter to change, and to advance to the next parameter, back up to the previous parameter, or to "exit" to the previous screen.

GROSS/NET – (Previous Menu or Parameter)

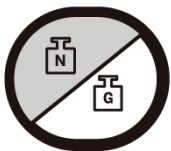

If at the menu level, this will take you to the next menu item in the list below. If **TIME SETTINGS** is currently displayed and the setup has been accessed through the calibration switch, then this will return you to **SCALE**. If setup has been accessed through setup review, pressing this when **TIME SETTINGS** is displayed will return you to **SYSTEM**. If at the parameter level, the exact item this takes you to may depend on a [parameter condition].

CALIBRATION SETUP, CONT.

Navigation Keys, Cont.

ID/HEIGHT – (Next Menu or Parameter)

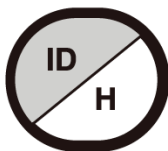

If at the menu level, this will take you to the previous menu item in the list below. If SCALE is currently displayed and the setup has been accessed through the calibration switch, then this will return you to TIME SETTINGS. If setup has been accessed through setup review, pressing this when SYSTEM is displayed will return you to TIME SETTINGS. If at the parameter level, the exact item this takes you to may depend on a [parameter condition].

PRINT – (Go up a level)

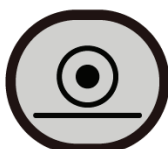

If at the parameter level, this returns you to the menu level. If at the menu level, this returns you to normal operation.

ENTER – (Go into Menu or save Parameter)



If at the menu level, this will take you to the first parameter in the currently displayed menu in the list below. If at the parameter level, this will store the currently displayed value for that parameter and proceed to the next parameter in the list below, which may depend on a [parameter condition].

Numeric Keys

The Numeric Keys are used to input values for the Calibration Setup parameters. Some parameter prompts require only a yes or no selection, while others require a numeric value to be entered.

NOTE: The 1 and 0 keys have dual functions. They are used to enter numeric values as well as to select no (0 = NO) or yes (1 = YES) to various prompts.



Calibration Setup Menu

SCALE	Scale Configuration. Proceed to the Scale Capacity parameter.
ZERO	Configure Zero functions. Proceed to the Zero Limit parameter.
FILTER	Analog to Digital Filtering. Proceed to the Filter Mode parameter.
CALIBRATION	Perform Calibration. Proceed to the Calibrate parameter.
GRAVITY	Gravity Constant Function. Proceed to the Enable Gravity parameter.
LOCK	Lock/Release feature. Proceed to the Hold Mode parameter.
SYSTEM	Operational Selections. Proceed to the Language parameter.
SERIAL PORT	Serial I/O Configuration. Proceed to the RS232 Mode parameter.
USB PORT	USB Port Configuration. Proceed to the USB Mode parameter.
BLE/WIFI	Bluetooth/Wi-Fi Configuration. <i>(Displayed if Redbird module is present)</i> . Refer to the Setup and Operation Manual for MedVue Medical Weight Analyzer with Wi-Fi and Bluetooth, 8555-0550-0M.
ETHERNET	Ethernet Configuration. <i>(Displayed if the MVIP option is present)</i> . Refer to the Model MVIP Ethernet Option Operation Manual, 8555-M520-O1.
TIME SETTINGS	Time and Date Configuration. Proceed to the Year parameter.

CALIBRATION SETUP, CONT.

SCALE

With **SCALE** displayed, press the **ENTER** key. The display will change to **CAPACITY**. Proceed to the **CAPACITY** (Scale Capacity) parameter.

Otherwise, press the **ID/HEIGHT** key to advance to the **ZERO** menu.

CAPACITY (Scale Capacity)

The display will show **CAPACITY** and the current setting. If the value displayed is acceptable, press the **ENTER** key to save it. Otherwise, use the numeric keys to enter a new value, and then press the **ENTER** key to save it.

Allowable values are 1 through 65,535.

OIML (OIML European Requirements)

The display will show **OIML** and the current setting. If the value displayed is acceptable, press the **ENTER** key to save it. Otherwise, use the numeric keys **0/NO** or **1/YES** to select a new setting, and then press the **ENTER** key to save it.

Allowable values are YES or no.

YES = OIML (European) specific requirements are enabled

no = OIML (European) specific requirements are disable

INTERVAL (Interval Setting)

The display will show **INTERVAL** and the current setting. If the value displayed is acceptable, press the **ENTER** key to save it. Otherwise, use the numeric keys to enter a new value, and then press the **ENTER** key to save it.

Allowable values are 1, 2, or 5.

dECIMAL (Decimal Point Position)

The display will show **dECIMAL** and the current setting. If the value displayed is acceptable, press the **ENTER** key to save it. Otherwise, use the numeric keys to enter a new value, and then press the **ENTER** key to save it.

Allowable values are 0, 1, 2, or 3.

0 = ##### 1 = #####.# 2 = #####.## 3 = ###.###

MOTION RANGE (Motion Range)

The motion range is the number of divisions of change permitted before indicating unstable (**STABLE** annunciator turns off).

The display will show **MOTION RANGE** and the current setting. If the value displayed is acceptable, press the **ENTER** key to save it. Otherwise, use the numeric keys to enter a new value, and then press the **ENTER** key to save it.

Allowable values are 0 through 9.

SAMPLE RATE (Sample Rate)

The display will show **SAMPLE RATE** and the current setting. If the value displayed is acceptable, press the **ENTER** key to save it. Otherwise, use the numeric keys to enter a new value, and then press the **ENTER** key to save it.

The sample rate may be set from a minimum of 1 sample per second to a maximum of 100 samples per second in one sample-per-second interval.

Allowable values are 1 through 100.

CALIBRATION SETUP, CONT.

ZERO

With ZERO displayed, press the **ENTER** key. The display will change to ZERO LIMIT. Proceed to the ZERO LIMIT (Two Percent Zero Tracking Range Limit) parameter.

Otherwise, press the **ID/HEIGHT** key to advance to the **FILTER** menu.

ZERO LIMIT (Two Percent Zero Tracking Range Limit)

This setting limits the scale to zero only + or - 2% of the scale capacity.

If enabled, (ZERO LIMIT = YES) zero tracking and push button zero are limited to 2% of scale capacity.

If disabled, (ZERO LIMIT = no) zero tracking and push button zero will operate up to full scale capacity.

The display will show ZERO LIMIT and the current setting. If the value displayed is acceptable, press the **ENTER** key to save it. Otherwise, use the numeric keys 0/NO or 1/YES to select a new setting, and then press the **ENTER** key to save it.

Allowable values are YES or no.

YES = 2% Zero Limit is Enabled

no = 2% Zero Limit is Disabled

POWER UP ZERO (Power Up Zero)

The display will show POWER UP ZERO and the current setting. If the value displayed is acceptable, press the **ENTER** key to save it. Otherwise, use the numeric keys 0/NO or 1/YES to select a new setting, and then press the **ENTER** key to save it.

Allowable values are YES or no.

YES = Weight display will be reset to zero automatically on power up

no = Weight display will not be reset to zero on power up

ZERO TRACKING (Zero Tracking)

The zero tracking is a value in scale divisions that will automatically zero the scale within the limits determined by the setting for this prompt.

The display will show ZERO TRACKING and the current setting. If the value displayed is acceptable, press the **ENTER** key to save it. Otherwise, use the numeric keys to enter a new value, and then press the **ENTER** key to save it.

Allowable values are 0 through 18 (1 to 9 divisions by 0.5 divisions).

For example, 1 = .5 grads, 2 = 1 grad, 3 = 1.5 grads, etc...

NOTE: Entering 0 (zero) will disable zero tracking.

CALIBRATION SETUP, CONT.

FILTER

With **FILTER** displayed, press the **ENTER** key. The display will change to **FILTER MODE**. Proceed to the **FILTER MODE** (Filter Type) parameter.

Otherwise, press the **ID/HEIGHT** key to advance to the **CALIBRATION** menu.

FILTER MODE (Filter Type)

The display will show **FILTER MODE** and the current setting. If the value displayed is acceptable, press the **ENTER** key to save it. Otherwise, use the numeric keys to enter a new value, and then press the **ENTER** key to save it.

Allowable values are 0, 1, or 2.

- 0 = None Disabled, No Filtering
- 1 = IIR Infinite Impulse Response – (slower response but better for higher capacity scales)
- 2 = FIR Finite Impulse Response – (faster response, better for filtering out vibration)

NOTE: The following prompt, **FILTER LEVEL** will only be displayed if you select option 1 or 2 for **FILTER MODE**.

FILTER LEVEL (Filter Level Selection – Only if FILTER MODE = 1 or 2)

The display will show **FILTER LEVEL** and the current setting. If the value displayed is acceptable, press the **ENTER** key to save it. Otherwise, use the numeric keys to enter a new value, and then press the **ENTER** key to save it.

Allowable values are 0, 1, or 2.

- 0 = Minimal Filtering 1 = Moderate Filtering 2 = Custom Filtering

NOTE: The following prompts, **FILTER BREAK** (Filter Break Range) and **FILTER VALUE** (Filter Value) will only be displayed if you select 2 (Custom Filtering) for **FILTER LEVEL**.

FILTER BREAK (Filter Break Range – Only if FILTER LEVEL = 2)

The filter break range is a number from 1 to 64 that corresponds to the number of division changes to break out of filtering.

The display will show **FILTER BREAK** and the current setting. If the value displayed is acceptable, press the **ENTER** key to save it. Otherwise, use the numeric keys to enter a new value, and then press the **ENTER** key to save it.

Allowable values are 1 through 64.

FILTER VALUE (Filter Value – Only if FILTER LEVEL = 2)

The filter level is a number from 1 to 16 that corresponds to the level of filtering with 1 being the least and 16 being the greatest filtering.

The display will show **FILTER VALUE** and the current setting. If the value displayed is acceptable, press the **ENTER** key to save it. Otherwise, use the numeric keys to enter a new value, and then press the **ENTER** key to save it.

Allowable values are 1 through 16.

CALIBRATION SETUP, CONT.

CALIBRATION

With CALIBRATION displayed, press the **ENTER** key. The display will change to CALIBRATE. Proceed to the CALIBRATE (Perform Calibration) parameter.

Otherwise, press the **ID/HEIGHT** key to advance to the GRAVITY menu.

CALIBRATE (Perform Calibration)

The display will show CALIBRATE and the current setting (no).

- If the scale has been previously calibrated and you wish to skip calibration (and retain the internal calibration factor), press the **ENTER** key. The display will change to GRAVITY ENABLE. Proceed to the GRAVITY menu, GRAVITY ENABLE parameter.
- If calibration is desired, press the **1/YES** key to select YES, and then press the **ENTER** key. The display will change to NUM CAL POINTS.

Allowable values are YES or no.

YES = Perform Calibration and
proceed to NUM CAL POINTS

no = Skip Calibration and proceed to
the GRAVITY ENABLE parameter

NUM CAL POINTS (Number of Calibration Points – Only if CALIBRATE = YES)

The MedVue Model MV1 Medical Weight Analyzer has two (2) modes that can be used to perform calibration. The calibration modes are as follows:

Single Calibration Point

This is a standard calibration method requiring one weight, an empty scale, and has one conversion factor. This method uses two calibration points (a test load on the scale and an empty scale) to establish a zero (no load) calibration value and to span the MV2.

Multi-point Calibration

This method requires two weights, an empty scale, and has two conversion factors. It uses three calibration points (a load on the scale, half the previous load, and an empty scale). The three points correspond to zero weight, mid-point weight, and test load (weight).

The display will show NUM CAL POINTS and the current setting. If the value displayed is acceptable, press the **ENTER** key to save it. Otherwise, use the numeric keys to enter a new value, and then press the **ENTER** key to save it.

Allowable values are 1 or 2.

1 = Single Calibration Point

2 = Multi-Point Calibration

CALIBRATION SETUP, CONT.

Single Calibration Point

LOADd CAL WT (Load Calibration Weight)

The display will show LOADd CAL WT (which is a prompt for entry of the calibration weight value) and the placement of this amount of test weight on the scale platform.

1. Make certain the scale platform is empty and free of debris.
2. When the display is showing LOADd CAL WT, the current setting for the calibration weight will be displayed also.
3. If the value displayed is acceptable, place the calibrated test weight on the scale platform, and then press the **ENTER** key. Proceed to Step 6.
4. Otherwise, determine the exact amount of test weight to be placed on the scale platform, and then using the numeric keys enter this value. Allowable values are 1 through scale capacity (refer to the capacity label on MV1).
NOTE: A minimum of 50% of the scale's capacity is required. However, 70% to 100% is recommended.
5. Verify that the numbers entered are the same as the amount of test weight, and then press the **ENTER** key.
6. The display will change to show PLEASE WAIT and then starting at the left and proceeding right, a series of dashes will appear on the display, and then starting at the right and proceeding left, disappear. Next, the display will change to UNLOAD SCALE.

UNLOAD SCALE (Unload Scale)

With the display showing UNLOAD SCALE:

1. Remove the weight from the scale platform.
2. Press the **ENTER** key.
3. The display will change to show PLEASE WAIT and starting at the left and proceeding right, a series of dashes will appear on the display, and then starting at the right and proceeding left, disappear.
4. Next, the display will change to show the GRAVITY ENABLE prompt.

CALIBRATION SETUP, CONT.

Multi-Point Calibration

CAL WEIGHT 1 (First Calibration Weight)

The display will show CAL WEIGHT 1 (which is a prompt for entry of the first calibration weight value) and the placement of this amount of test weight on the scale platform.

NOTE: The MV1 defaults to half ($\frac{1}{2}$) of the scale capacity.

1. Make certain the scale platform is empty and free of debris.
2. When the display shows CAL WEIGHT 1, the current setting for the first calibration weight will be displayed also. If the value displayed is acceptable, place the calibrated test weight on the scale platform, and then press the **ENTER** key. Proceed to Step 5.
3. Otherwise, determine the exact amount of test weight to be placed on the scale platform, and then use the numeric keys to enter this value. Allowable values are 1 through scale capacity (refer to the capacity label on MV1).
4. Verify that the numbers entered are the same as the amount of test weight, and then press the **ENTER** key.
5. The display will change to show PLEASE WAIT and starting at the left and proceeding right, a series of dashes will appear on the display, and then starting at the right and proceeding left, disappear. Next, the display will change to CAL WEIGHT 2.

CAL WEIGHT 2 (Second Calibration Weight)

The display will show CAL WEIGHT 2 (which is a prompt for entry of the second calibration weight value) and the placement of this amount of test weight on the scale platform.

NOTE: The MV1 defaults to full scale capacity.

1. When the display is showing CAL WEIGHT 2, the current setting for the second calibration weight will be displayed also. If the value displayed is acceptable, place the calibrated test weight on the scale platform, and then press the **ENTER** key. Proceed to Step 4.
2. Otherwise, determine the exact amount of test weight to be placed on the scale platform, and then use the numeric keys to enter this value. Allowable values are 1 through scale capacity (refer to the capacity label on MV1).
3. Verify that the numbers entered are the same as the amount of test weight, and then press the **ENTER** key.
4. The display will change to show PLEASE WAIT and starting at the left and proceeding right, a series of dashes will appear on the display, and then starting at the right and proceeding left, disappear. Next, the display will change to UNLOAD SCALE.



NOTE: If the same weight is used for CAL WEIGHT 1 and CAL WEIGHT 2, then the scale reverts to a Single Point calibration.

UNLOAD SCALE (Unload Scale)

With the display showing UNLOAD SCALE:

1. Remove the weight from the scale platform.
2. Press the **ENTER** key.
3. The display will change to show PLEASE WAIT and starting at the left and proceeding right, a series of dashes will appear on the display, and then starting at the right and proceeding left, disappear.
4. Next, the display will change to show the GRAVITY ENABLE prompt.

CALIBRATION SETUP, CONT.

GRAVITY

With **GRAVITY** displayed, press the **ENTER** key. The display will change to **GRAVITY ENAbLE**. Proceed to the **GRAVITY ENAbLE** (Enable Gravity Constant) parameter.

Otherwise, press the **ID/HEIGHT** key to advance to the **LOCK** menu.

GRAVITY ENAbLE (Enable Gravity Constant)

The Detecto MedVue® Model MV1 Weight Analyzer is equipped with a gravity constant function which means that it can be calibrated in one location and then adjusted to match the gravity at the location where it will be operated.

The display will show **GRAVITY ENAbLE** and the current setting. If the value displayed is acceptable, press the **ENTER** key to save it. Otherwise, use the numeric keys **0/NO** or **1/YES** to select a new setting, and then press the **ENTER** key to save it.

Allowable values are YES or no.

YES = Enable Gravity Constant and proceed to CAL GRAVITY parameter	no = Disable Gravity Constant and proceed to the HOLD MODE parameter
--	--

CAL GRAVITY (Calibrated Gravity Constant – Only if GRAVITY ENAbLE = YES)

This is the gravity constant of the location where the scale was calibrated.

NOTE: Consult the factory Tech Support for the Gravity Constant for your location.

The display will show **CAL GRAVITY** and the current setting. If the value displayed is acceptable, press the **ENTER** key to save it. Otherwise, use the numeric keys to enter a new value, and then press the **ENTER** key to save it.

Allowable values are 0 through 99,999.

OP GRAVITY (Operating Gravity Constant – Only if GRAVITY ENAbLE = YES)

This is the gravity constant for the location where the scale will be operated.

NOTE: Consult the factory Tech Support for the Gravity Constant for your location.

The display will show **OP GRAVITY** and the current setting. If the value displayed is acceptable, press the **ENTER** key to save it. Otherwise, use the numeric keys to enter a new value, and then press the **ENTER** key to save it.

Allowable values are 0 through 99,999.

CALIBRATION SETUP, CONT.

LOCK

With **LOCK** displayed, press the **ENTER** key. The display will change to **HOLD MODE**. Proceed to the **HOLD MODE** (Hold Mode) parameter.

Otherwise, press the **ID/HEIGHT** key to advance to the **SYSTEM** menu.

HOLD MODE (Hold Mode)

The Hold Mode Sets the locking functionality of the MV1.

The display will show **HOLD MODE** and the current setting. If the value displayed is acceptable, press the **ENTER** key to save it. Otherwise, use the numeric keys to enter a new value, and then press the **ENTER** key to save it.

Allowable values are 0, 1, or 2.

0 = Hold Mode Disabled

1 = Hold Mode Enabled. Displayed weight locked by the **LOCK/RELEASE** key only

2 = Hold Mode Enabled. Display weight locked by Auto-Lock

- If **HOLD MODE = 0** or **1** is selected, proceed to the **LANGUAGE** prompt.
- If **HOLD MODE = 2** is selected, an additional prompt **HOLD BAND** will be displayed. Proceed to **HOLD BAND** (Auto Lock Reset Band) to continue setup.

With the Hold Mode enabled (**HOLD MODE = 1**), the MV1 will lock the weight shown on the display when the **LOCK/RELEASE** key is pressed and unlock the weight display when you press the key again.

If (**HOLD MODE = 2**) is selected, the MV1 will automatically lock the weight shown on the display after obtaining a stable weight and will unlock the weight display when the weight is removed from the scale (patient is off the scale). Note that the stable weight must exceed the **HOLD BAND** (Auto Lock Reset Band) value. Refer to the next prompt **HOLD BAND** (Auto Lock Reset Band).

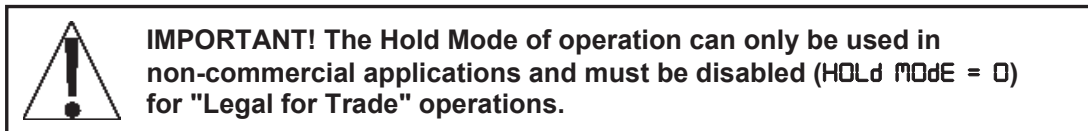

HOLD BAND (Auto Lock Reset Band – Only if HOLD MODE = 2)

If (**HOLD MODE = 2**) is selected, the display will change to show **HOLD BAND**. This is the number of division changes needed to reset the Auto Lock. For the Auto Lock to function, the load on the scale must rise above the **HOLD BAND** value (and remain stable). To release the Auto Lock, the load on the scale must fall below the **HOLD BAND** value. At that point, the next weighing operation can begin.

The display will show **HOLD BAND** and the current setting. If the value displayed is acceptable, press the **ENTER** key to save it. Otherwise, use the numeric keys to enter a new value, and then press the **ENTER** key to save it.

Allowable values are 0 through 99.

CALIBRATION SETUP, CONT. (Non-Protected Setup Parameters)

SYSTEM

With SYSTEM displayed, press the **ENTER** key. The display will change to LANGUAGE. Proceed to the LANGUAGE (Language) parameter.

Otherwise, press the **ID/HEIGHT** key to advance to the SERIAL PORT menu.

LANGUAGE (Language)

The display will show LANGUAGE and the current setting. If the value displayed is acceptable, press the **ENTER** key to save it. Otherwise, use the numeric keys to enter a new value, and then press the **ENTER** key to save it.

Allowable values are 0, 1, 2, or 3.

0 = English 1 = Spanish 2 = French 3 = German



NOTE: The default language is English. Changing the language at this prompt will change all subsequent prompts and displays to the language selected.

BACKLIGHT (Backlight Intensity)

The display will show BACKLIGHT and the current setting. If the value displayed is acceptable, press the **ENTER** key to save it. Otherwise, use the numeric keys to enter a new value, and then press the **ENTER** key to save it.

Allowable values are 0 through 255.

0 = Backlight OFF through 255 = Backlight at full intensity



NOTE: The backlight intensity setting will affect battery life. A lower intensity setting will conserve power and maximize battery operation.

KEYPAD bEEP (Allow Keypad Beep)

This setting determines whether the MV1 beeps each time a key is pressed.

The display will show KEYPAD bEEP and the current setting. If the value displayed is acceptable, press the **ENTER** key to save it. Otherwise, use the numeric keys 0/NO or 1/YES to select a new setting, and then press the **ENTER** key to save it.

Allowable values are YES or no.

YES = The MV1 beeps each time a key is pressed. no = MV1 does not beep when a key is pressed.

CALIBRATION SETUP, CONT.

SLEEP MODE (Sleep Mode)

The Sleep Mode feature conserves power when the MV1 remains unused for a selected time (approximately 1 to 9 minutes). When enabled, the display will show the date and time and the backlight will be turned off. The Sleep Mode feature requires the MV1 to remain at a stable zero weight to activate. Weight placed on the scale or pressing any key will activate the MV1 and return it to weight mode.

The display will show SLEEP MODE and the current setting. If the value displayed is acceptable, press the **ENTER** key to save it. Otherwise, use the numeric keys to enter a new value, and then press the **ENTER** key to save it.

Allowable values are 0 through 9.

NOTE: Selecting 0 disables the Sleep Mode feature.

AUTO SHUT OFF (Auto-Shut Off Feature for Battery Operation)

When powered by batteries, the Auto Shut Off feature will automatically turn the MV1 off (when it is not used) after a predetermined period of inactivity (approximately 1 to 9 minutes) to conserve battery power. To turn the MV1 back on you must press the **ON/OFF** key.

NOTE: When powered by the 12VDC wall plug-in AC power adapter, the Auto-Shutoff feature will not turn the MV1 off. You must press the **ON/OFF** key to turn it off.

The display will show AUTO SHUT OFF and the current setting. If the value displayed is acceptable, press the **ENTER** key to save it. Otherwise, use the numeric keys to enter a new value, and then press the **ENTER** key to save it.

Allowable values are 0 through 9.

NOTE: Selecting 0 disables the Auto Shut Off feature.

KEY DISABLE (Disable Key Operation)

This parameter determines which keys (**NET/GROSS**, **TARE**, and/or **ID/HEIGHT**) are locked out during normal operation.

The display will show KEY DISABLE and the current setting. If the value displayed is acceptable, press the **ENTER** key to save it. Otherwise, use the numeric keys to enter a new value, and then press the **ENTER** key to save it.

Allowable values are 0, 1, 2, or 3.

- 0 = No Keys Disabled
- 1 = NET/GROSS and TARE Keys Disabled
- 2 = ID/HEIGHT Keys Disabled
- 3 = NET/GROSS, TARE, and ID/HEIGHT Keys Disabled

ENABLE ID (ID Number Feature)

This setting determines whether the MV1 operates in the Transaction Storage Mode (no ID storage) or the ID Storage Mode and whether the MV1 allows an ID number to be entered before beginning the weighing operation. This applies to both Basic Operation and with the BMI feature enabled. **NOTE:** The ID Storage Mode allows up to 99 IDs.

The display will show ENABLE ID and the current setting. If the value displayed is acceptable, press the **ENTER** key to save it. Otherwise, use the numeric keys 0/NO or **1/YES** to select a new setting, and then press the **ENTER** key to save it.

Allowable values are YES or no.

YES = ID Enabled, uses ID
Storage Mode

no = ID Disabled, uses Transaction
Storage Mode

CALIBRATION SETUP, CONT.

bARCOdE (Use ID Scanner)

This setting determines whether the MV1 allows a scanner to be used to input an ID number to be entered before beginning the weighing operation. This applies to both Basic Operation and with the BMI feature enabled.

The display will show bARCOdE and the current setting. If the value displayed is acceptable, press the **ENTER** key to save it. Otherwise, use the numeric keys 0/NO or 1/YES to select a new setting, and then press the **ENTER** key to save it.

Allowable values are YES or no.

YES = An ID Scanner is used to input the ID number no = An ID Scanner is not used

USE HEIGHT (Allow Height Functions)

This setting determines whether the height functions are allowed and if the Height Units prompt is shown.

The display will show USE HEIGHT and the current setting. If the value displayed is acceptable, press the **ENTER** key to save it. Otherwise, use the numeric keys 0/NO or 1/YES to select a new setting, and then press the **ENTER** key to save it.

Allowable values are YES or no.

YES = The Height functions are allowed and the HEIGHT UNITS prompt will be displayed no = The Height functions are not allowed. Proceed to the HI RESOLUTION parameter

NOTE: If USE HEIGHT = no (no) is selected, the time will be shown on the display in the location where the height normally would be.

HEIGHT UNITS (Height Units – Only if USE HEIGHT = YES and UNITS > 1)

The display will show HEIGHT UNITS and the current setting. If the value displayed is acceptable, press the **ENTER** key to save it. Otherwise, use the numeric keys to enter a new value, and then press the **ENTER** key to save it.

Allowable values are 1 or 2.

1 = Centimeters 2 = Millimeters

bODY MASS IdX (Body Mass Index, BMI Calculation Feature)

This setting determines whether the MV1 performs basic weight calculation only or performs the Body Mass Index (BMI) calculations.

The display will show bODY MASS IdX and the current setting. If the value displayed is acceptable, press the **ENTER** key to save it. Otherwise, use the numeric keys 0/NO or 1/YES to select a new setting, and then press the **ENTER** key to save it.

Allowable values are YES or no.

YES = Body Mass Index is Enabled and MV1 performs BMI calculations no = Body Mass Index is Disabled and the MV1 performs basic weight calculations only

CALIBRATION SETUP, CONT.

HI RESOLUTION (High-Resolution Mode)

The High-Resolution Mode feature will display the weight at 10 times the standard resolution. For example, an MV1 configured for 400 lb x 0.2 lb will display weight in high-resolution mode at 400 lb x 0.02 lb. **NOTE:** If `RESOLUTION=3`, the High-Resolution Mode is not available.

The display will show HI RESOLUTION and the current setting. If the value displayed is acceptable, press the **ENTER** key to save it. Otherwise, use the numeric keys 0/NO or **1/YES** to select a new setting.

Allowable values are YES or no.

YES = If High-Resolution Weight
mode is desired

no = High-Resolution Weight
mode is not desired

If viewing the High-Resolution Weight mode *immediately* is desired:

1. With HI RESOLUTION displayed press the **1/YES** key.
2. Press the **ENTER** key.
3. The display will change to RS232 MODE.
4. Press the **PRINT** key twice.
5. The MV1 will reset and display the weight in High-Resolution mode.

Otherwise, after selecting the value for the High-Resolution mode parameter, press the **ENTER** key to save the selection and advance to the SERIAL PORT, RS232 MODE (RS232 Port Output Mode) parameter to continue Calibration Setup.

CALIBRATION SETUP, CONT.

SERIAL PORT

With SERIAL PORT displayed, press the **ENTER** key. The display will change to RS232 MODE. Proceed to the RS232 MODE (RS232 Port Output Mode) parameter.

Otherwise, press the **ID/HEIGHT** key to advance to the USB PORT menu.

RS232 MODE (RS232 Port Output Mode)

The display will show RS232 MODE and the current setting. If the value displayed is acceptable, press the **ENTER** key to save it. Otherwise, use the numeric keys to enter a new value, and then press the **ENTER** key to save it.

Allowable values are 0, 1, 2, or 3.

- 0 = RS232 Port Output Mode is Disabled
- 1 = RS232 Port Output Mode is set for Weight on Demand
- 2 = RS232 Port Output Mode is set for Continuous Data
- 3 = RS232 Port Output Mode is set for a Printer

BAUD RATE (Serial Output Baud Rate – Only if RS232 MODE = 1, 2, or 3)

The display will show BAUD RATE and the current setting. If the value displayed is acceptable, press the **ENTER** key to save it. Otherwise, use the numeric keys to enter a new value, and then press the **ENTER** key to save it.

Allowable values are 1 through 9, and 0.

- | | | |
|---------------|----------------|-----------------|
| 1 = 2400 Baud | 4 = 14.4k Baud | 7 = 38.4k Baud |
| 2 = 4800 Baud | 5 = 19.2k Baud | 8 = 56k Baud |
| 3 = 9600 Baud | 6 = 28.8k Baud | 9 = 57.6k Baud |
| | | 0 = 115.2k Baud |

PRINTER TYPE (Set Type of Printer Output – Only if RS232 MODE = 3)

The display will show PRINTER TYPE and the current setting. If the value displayed is acceptable, press the **ENTER** key to save it. Otherwise, use the numeric keys to enter a new value, and then press the **ENTER** key to save it.

Allowable values are 0, 1, 2, or 3.

- 0 = Print default ticket (P185 or other types of ASCII printers)
- 1 = Print journal line
- 2 = Print label (P220)
- 3 = Print nControl ticket (must have loaded a ticket format, otherwise will use default ticket)

END OF PRINT (End of Print Linefeeds – Only if RS232 MODE = 3)

At the end of data sent to a printer, the MV1 can send several carriage return/line feeds to space the paper in the printer to the desired position for withdrawal or the next print.

The display will show END OF PRINT and the current setting. If the value displayed is acceptable, press the **ENTER** key to save it. Otherwise, use the numeric keys to enter a new value, and then press the **ENTER** key to save it.

Allowable values are 0 through 9.

CALIBRATION SETUP, CONT.

USB PORT

With **USB PORT** displayed, press the **ENTER** key. The display will change to **USB MOD**. Proceed to the **USB MOD** (USB Port Output Mode) parameter.

Otherwise, press the **ID/HEIGHT** key to advance to the **TIME SETTINGS** menu.

NOTE: If the Redbird Wi-Fi and Bluetooth Low Energy (BLE) wireless transmitter module is installed, pressing the **ID/HEIGHT** key will advance to the Bluetooth/Wi-Fi parameters with the display showing **REdbIRD REV** and the Redbird Software version in large numbers at the top of the display. Refer to the Setup and Operation Manual for MedVue Medical Weight Analyzer with Wi-Fi and Bluetooth, 8555-0550-0M.

USB MOD (USB Port Output Mode)

The display will show **USB MOD** and the current setting. If the value displayed is acceptable, press the **ENTER** key to save it. Otherwise, use the numeric keys to enter a new value, and then press the **ENTER** key to save it.

Allowable values are 0, 1, 2, 3, or 4.

- 0 = USB Port Output Mode is Disabled
- 1 = USB Port Output Mode is set for Weight on Demand (requires serial driver .inf file for Windows)
- 2 = USB Port Output Mode is set for Continuous Data (requires serial driver .inf file for Windows)
- 3 = USB Port Output Mode is set for a Printer (only works for printers with an internal font)
- 4 = USB Port Output Mode is set for Welch Allyn Operation

NOTE: Requires device to have an activated license. Must purchase Detecto WACONNECT.

PRINTER TYPE (Set Type of Printer Output – Only if USB MOD = 3)

The display will show **PRINTER TYPE** and the current setting. If the value displayed is acceptable, press the **ENTER** key to save it. Otherwise, use the numeric keys to enter a new value, and then press the **ENTER** key to save it.

Allowable values are 0, 1, 2, or 3.

- 0 = Print default ticket
- 1 = Print journal line
- 2 = Print label
- 3 = Print nControl ticket (must have loaded a ticket format, otherwise will use default ticket)

END OF PRINT (End of Print Linefeeds – Only if USB MOD = 3)

At the end of data sent to a printer, the MV1 can send several carriage return/line feeds to space the paper in the printer to the desired position for withdrawal or the next print.

The display will show **END OF PRINT** and the current setting. If the value displayed is acceptable, press the **ENTER** key to save it. Otherwise, use the numeric keys to enter a new value, and then press the **ENTER** key to save it.

Allowable values are 0 through 9.

CALIBRATION SETUP, CONT.

TIME SETTINGS

With **TIME SETTINGS** displayed, press the **ENTER** key.

The display will change to **YEAR [YYYY]**. Proceed to the **YEAR [YYYY]** (Year) parameter.

Otherwise, press the **ID/HEIGHT** key to return to the **SCALE** menu.

YEAR [YYYY] (Year)

The display will show **YEAR [YYYY]** and the current setting. If the value displayed is acceptable, press the **ENTER** key to save it. Otherwise, use the numeric keys to enter a new value, and then press the **ENTER** key to save it.

Allowable values are 2012 through 2099.

MONTH [1- 12] (Month)

The display will show **MONTH [1- 12]** and the current setting. If the value displayed is acceptable, press the **ENTER** key to save it. Otherwise, use the numeric keys to enter a new value, and then press the **ENTER** key to save it.

Allowable values are 1 through 12.

1 = January	5 = May	9 = September
2 = February	6 = June	10 = October
3 = March	7 = July	11 = November
4 = April	8 = August	12 = December

DAY [1-3 1] (Day)

The display will show **DAY [1-3 1]** and the current setting. If the value displayed is acceptable, press the **ENTER** key to save it. Otherwise, use the numeric keys to enter a new value, and then press the **ENTER** key to save it.

Allowable values are 1 through 31.

HOUR [0-23] (Hour)

The display will show **HOUR [0-23]** and the current setting. If the value displayed is acceptable, press the **ENTER** key to save it. Otherwise, use the numeric keys to enter a new value, and then press the **ENTER** key to save it.

Allowable values are 0 through 23.

NOTE: The hour is entered in a 24-hour format. When entering the hour after **NOON** (12:00 PM), you must add 12 to the time. For example, 3:00 PM would be entered as 15.

MINUTE [0-59] (Minutes)

The display will show **MINUTE [0-59]** and the current setting. If the value displayed is acceptable, press the **ENTER** key to save it. Otherwise, use the numeric keys to enter a new value, and then press the **ENTER** key to save it.

Allowable values are 0 through 59.

SECONd [0-59] (Seconds)

The display will show **SECONd [0-59]** and the current setting. If the value displayed is acceptable, press the **ENTER** key to save it. Otherwise, use the numeric keys to enter a new value, and then press the **ENTER** key to save it.

Allowable values are 0 through 59.

CALIBRATION SETUP, CONT.

24 HOUR TIME (Use 24 Hour Time Format)

The display will show 24 HOUR TIME and the current setting. If the value displayed is acceptable, press the **ENTER** key to save it. Otherwise, use the numeric keys 0/NO or 1/YES to select a new setting, and then press the **ENTER** key to save it.

Allowable values are YES or no.

YES = Use 24 Hour Time Format
(3 PM displays 15:00)

no = Use 12 Hour Time Format
(3 PM displays 3:00)

Calibration Setup is Complete

The Calibration Setup process has been completed. The MV1 will reset and return to the weight mode. Press the **ON/OFF** key to turn the MedVue off. Re-install the end cap and secure it with the two (2) screws removed earlier. The MV1 is now ready for normal operation.

SETUP REVIEW

(Non-Protected Setup Parameters)

The MedVue Model MV1 Medical Weight Analyzer allows several operational parameters to be reviewed and changed as necessary without having to remove the end cap, pressing the calibration switch, or breaking any seals to enter the Non-Protected Calibration Setup mode.

To Enter Setup Review

With the MV1 on and in the normal Gross weight mode:

1. Press and hold the **CLEAR** key for approximately 3 seconds.
2. The display will change to show SETUP REVIEW in small letters at the bottom of the display.
3. Release the **CLEAR** key.
4. The display will change to show:

With SYSTEM displayed, press the **ENTER** key. The display will change to LANGUAGE. Note that continued pressing of the **ENTER** key will advance you through the Setup Review parameters. For information and instructions on how to change these parameters, refer to the Calibration Setup (Non-Protected Setup Parameters) section of this manual.

Parameters in Setup Review will be processed in the following sequence:

SYSTEM

LANGUAGE	Select MV1 operation language
BACKLIGHT	Set Backlight Intensity
KEYPAD BEEP	Enable or Disable MV1 emitting a beep when a key is pressed
SLEEP MODE	Disable or select the number of minutes of inactivity for sleep mode
AUTO SHUT OFF	Disable or select the number of minutes for the auto-shutoff timer for battery operation
KEY DISABLE	Enable or Disable NET/GROSS , TARE , and/or ID/HEIGHT keys
ENABLE ID	Enable or Disable transaction storage and ID number input feature
BARCODE	Enable or Disable barcode scanning of IDs
USE HEIGHT	Enable or Disable Height Functions
HEIGHT UNITS*	Select Centimeters or Millimeters for height measuring units
BODY MASS IDX*	Enable or Disable Body Mass Index (BMI) calculation feature
HI RESOLUTION	Enable the High-Resolution Weight Mode feature

***NOTE:** HEIGHT UNITS and BODY MASS IDX will only be shown if USE HEIGHT is set to YES.

SETUP REVIEW, CONT.

SERIAL PORT

RS232 MODE	Set the mode of the RS232 serial port
BAUD RATE	Set baud rate for RS232 serial port (If RS232 MODE = 1, 2 or 3)
PRINTER TYPE	Set the type of printer output (If RS232 MODE = 3)
End OF PRINT	Set Number of End of Print linefeeds (If RS232 MODE = 3)

USB PORT

USB MODE	Set the mode of the USB port
PRINTER TYPE	Set the type of printer output (If USB MODE = 3)
End OF PRINT	Set Number of End of Print linefeeds (If USB MODE = 3)

BLE/WIFI

Displayed if Redbird module is present. Bluetooth/Wi-Fi Configuration. Refer to manual 8555-0550-0M, Setup and Operation Manual for MedVue Medical Weight Analyzer with Wi-Fi and Bluetooth.

ETHERNET

Displayed if MVIP option is present. Ethernet Configuration. Refer to manual 8555-M520-O1, Model MVIP Ethernet Option Operation Manual.

TIME SETTINGS

YYYY [YYYY]	Set the Year
MONTH [1- 12]	Set the Month of the year
DAY [1-30]	Set the Day of the month
HOUR [0-23]	Set the Hours portion of the time (Entered in a 24-hour format)
MINUTE [0-59]	Set the Minutes portion of the time
SECOND [0-59]	Set the Seconds portion of the time
24 HOUR TIME	Select to use 24-hour time format (3 PM displays 15:00)

Setup Review Is Complete

The setup review process has been completed. The MV1 will reset and return to the weight mode. The MV1 is now ready for normal operation.

WEIGHT ON DEMAND FORMATS

Weight on Demand

If the continuous output was not selected for the serial port, RS232 Mode=0, the USB Device port, USB Mode=0, or the optional Ethernet/Wi-Fi port, ETHERNET Mode=0, and the indicator is connected to a computer for transmission of weight data to a PC-based EMR (electronic medical record) software program, it will transmit a single set of weight data each time the computer sends a weight request "ENQ" (hex 05) or an SMA weight request "W". This is known as Weight-On-Demand. Examples and explanations of the data format transmitted are shown below.

<ENQ> - (Hex 05)

Character sent to the MedVue weight analyzer will respond with the following weight string:

Pxxxxx^UU^M^SS^CR (no decimal point in weight)

PxxxxxD^UU^M^SS^CR (decimal point in weight)

Where:

P = polarity (space if positive, - if negative)

xxxxx = weight with leading spaces

D = decimal point (embedded where necessary)

^ = space (hex 20)

UU = units, upper case (LB or KG)

M = mode, upper case (G=gross, N=Net)

SS = status, upper case (CZ=center-of-zero,

MO=motion, BZ=gross weight below zero

EE=entry - Input in progress, OC=over capacity)

CR = carriage return (hex 0D)

<LF>W<CR>

The string sent to the MedVue weight analyzer will respond with the SMA weight string:

<LF>S1GM^DDDDDDDDDDUUU<CR>

Where:

<LF> = Line feed character (hex 0A)

S = Status ('O' = Over Cap, 'Z' = Center Zero, 'U' = Below Zero, 'E' = Error)

1 = The number '1'

G = Mode of operation ('G' = Gross, 'N' = Net, 'T' = Tare)

M = Motion bit ('M' = Motion, ' ' = Settled)

^ = Space

DDDDDDDDDD = Weight with a decimal point if necessary

UUU = Units (e.g. 'lb 'or 'kg ')

<CR> = Carriage return (hex 0D)

SERIAL AND USB DEVICE PORT COMMANDS

The following commands and formats apply to both the Serial port and the USB Device port. Both the Serial port and USB Device port on the MedVue weight analyzer are bi-directional ports and can receive and transmit data. However, the USB Device port can only communicate with a computer. The Serial port can output to a printer as well as communicate to a computer.

Serial Port

Using the serial port, it is possible to control the printing operation of the MedVue weight analyzer by transmitting commands to the indicator. Note that the R5232 MODE parameter must be set to 3 = Printer to allow this.

USB Device Port

NOTE: For the computer to communicate to the indicator using the USB Device port, the remote computer requires the USB driver (MedVue.inf, available on the Detecto Dealer Web Site), and the USB MODE parameter must be set to 3 = Printer.

Print Command

The host device (computer) sends:

<LF> P <CR>

This command is equivalent to pressing the **PRINT** key on the MedVue weight analyzer keypad. The MedVue weight analyzer will respond by printing a ticket using the serial port (or by transmitting data using the USB Device port). The ticket will be printed (or data transmitted) in the following format:

If Pounds was selected for UNITS

mm/dd/yyyy, HH:MM

ID: xxxxxxxxxxxxx
Weight: wwwwww uu G
 wwwwww uu T
 wwwwww uu N
Height: F' II.I"
BMI: BB.B

If Kilograms was selected for UNITS

dd/mm/yyyy, HH:MM

ID: xxxxxxxxxxxxx
Weight: wwwwww uu G
 wwwwww uu PT
 wwwwww uu N
Height: HHH.H cm
BMI: BB.B

Where:

mm/dd/yyyy = Date, month/day/year (Pounds format)

dd/mm/yyyy = Date, day/month/year (Kilogram format)

HH:MM = Time, Hours, Minutes

xxxxxxxxxxxxx = ID (14 characters)

wwwwww = Weight

uu = Units (lb or kg)

G = Gross

T = Tare

N = Net

F' = Height in Feet

II.I" = Height in Inches

HHH.H cm = Height in Centimeters

BB.B = Body Mass Index Calculation

SERIAL AND USB DEVICE PORT COMMANDS, CONT.

Journal Mode Print Command

The host device (computer) sends:

<LF> J <CR>

This command is equivalent to pressing the **PRINT** key on the MedVue weight analyzer keypad. The MedVue weight analyzer will respond by printing a ticket using the serial port (or by transmitting data using the USB Device port). The ticket will be printed (or data transmitted) in the following format:

ID: xxxxxxxxxxxxxx, DATE: date, TIME: time, WEIGHT: displayed weight, units, HEIGHT: ht, BMI: BMI <CR><LF>

This command is equivalent to pressing the **PRINT** key on the MedVue weight analyzer keypad with the **PRINTER TYPE** set for Print Journal Line (**PRINTER TYPE = I**) parameter selected.

NOTE: If the **ENABLE ID** (ID number) or **BODY MASS IDX** (BMI Calculation) features are disabled, the field will be left out on any three formats.

Data Queue Commands

The MedVue weight analyzer has been equipped with storage for weight records. When taking a weight record, once the **PRINT** key is pressed, the weight, ID (if enabled and entered), date, and time are stored in the indicator. The indicator can store up to 200 weight records. Once the limit is reached, the oldest record will be overwritten to make room for the new weight record.

Delete Data Queue Command

The host device (computer) sends:

<LF> XD <CR>

The MedVue weight analyzer will Delete the Data Queue.

Recall Data Queue Command

The host device (computer) sends:

<LF> XS <CR>

The MedVue weight analyzer will Recall the Data Queue. The ticket will be printed (or data transmitted) in the following format:

ID, Date, Time, Weight, Units, Mode<cr><lf>

Where:

ID =	xxxxxxxxxx	Up to 11-digit ID number
Date =	mm/dd/yy	Month, Day, Year
Time =	hh:mm	Hours and Minutes
Weight =	xxxxx.x	Six digits with a decimal point
Units =	uu	None, lb or kg
m =	Mode	G = Gross
cr =	Carriage Return	(hex 0D)
lf =	Line Feed	(hex 0A)

NOTE: Recalling the data queue does not delete the current data. The separate delete command must be sent to clear the queue.

SERIAL AND USB DEVICE PORT COMMANDS, CONT.

<LF>P<CR>

The weight analyzer will respond with all information formatted with each item on a separate line.

<LF>J<CR>

The weight analyzer will respond with all information formatted with each item separated by commas (comma-delimited) followed by a carriage return.

<LF>Z<CR>

Zero the scale within the constraints of the zero settings.

<LF>T<CR>

The scale attempts to tare itself setting the tare weight to the current gross weight.

<LF>T<xxxxxx.xxx><CR>

The scale attempts to set the weight (represented as<xxxxxx.xxx> in the string) to the requested value.

<LF>M<CR>

The scale returns the current tare weight.

<LF>A<CR>

The scale will respond with:

<LF>MedVue<CR>

<LF>XH<CR>

The scale will respond with the current height:

<LF>Height<CR>

<LF>XB<CR>

The scale will respond with the current BMI:

<LF>BMI<CR>

<LF>XI<CR>

The scale will respond with the currently entered ID:

<LF>ID<CR>

<LF>XA<CR>

The scale will respond with current weight, height, BMI, and ID in comma-delimited format:

<LF> weight (see <LF>W<CR> above), Height, BMI, ID<CR>

NOTE: If the weight analyzer has been set to the continuous mode of outputting weight, it will output the weight in the format listed above for <LF>W<CR> every 500 milliseconds.

ERROR AND STATUS DISPLAYS

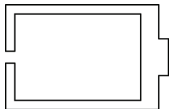
Display	Meaning
ERROR	General error, invalid keypad entry was attempted.
ERR OVERFLOW	Attempting to display a negative number greater than –9,999 or a positive number greater than 99,999
ERR ZERO LIM	Indicates an attempt to zero a weight outside the scale zero range. Refer to the Calibration Setup ZERO Menu, ZERO LIMIT (Two Percent Zero Tracking Range Limit) parameter.
ERR UNSTABLE	Motion is present when MV1 is attempting to perform one of the following operations: Power Up Zero or Zero Weight Display
OVER CAPACITY	Scale weight exceeds scale capacity.
	When the batteries are near the point they need to be replaced (Alkaline) or recharged (NiCad or NiMH), the battery status symbol <u>will not show</u> any bars. If the battery voltage drops too low for accurate weighing, the MV1 will automatically shut off and you will be unable to turn it back on.
CAL REQUIRED	Indicates improperly stored calibration data. Calibration of MV1 is required. Consult your scale service representative.
ERR ANALOG	An analog-to-digital converter communication error has been detected. Consult your scale service representative.
ANALOG LOW	The load cell input is <u>below</u> the range of the MV1. Consult your scale service representative.
ANALOG HI	The load cell input is <u>above</u> the range of the MV1. Consult your scale service representative.
ERR EEPROM	NOVRAM failure. Consult your scale service representative.

BEFORE YOU CALL FOR SERVICE

Problem	Possible Solutions
Display does not turn on	<p>AC Operation:</p> <ul style="list-style-type: none"> • Is the AC power supply fully inserted into the wall outlet? • Check the wall outlet for proper AC power. Try another electrical appliance in the same outlet, does it work? • Check the circuit breaker. • Has there been a power failure? <p>Battery operation:</p> <ul style="list-style-type: none"> • Check if the batteries are installed and correctly. • Is the battery status symbol empty (no bars are displayed)? If Alkaline, remove the old batteries and replace them with new batteries. If NI-CAD or NiMH, remove discharged batteries and replace them with fully charged ones. Place discharged batteries in an external charger to recharge.
Incorrect weight is displayed	Ensure that the scale platform is not touching an adjacent object. Have proper operation procedures been followed?
Weight is not displayed	Refer to the Error and Status Display section.
Height is not displayed	The digital height rod was not in its “starting position” before turning on the MV1. The inner sliding tube <u>must</u> be completely down inside the outer stationary tube and the headpiece folded flat against the stationary tube before turning on the MV1.

CARE AND CLEANING



NOTE: The MV1 contains no user-serviceable parts and maintenance should be limited to an occasional cleaning and battery replacement as required.

- Do not submerge the MV1 in water, pour, or spray water directly on it to clean it. The MV1 is not waterproof and covering it with water will damage it and void the warranty.
- Always remove power before cleaning.
- Do not use wire brushes, abrasives, or cleaning tools such as steel pads and scrapers, which will scratch the painted surface. Instead, use soft cloths or plastic scouring pads for cleaning.
- When possible, use treated water. Hard water can leave behind deposits. Soft water is much gentler on the painted steel's surface.
- Avoid the use of acetone, thinner or other volatile solvents, and abrasive type cleaners for cleaning. If required, a mild solvent such as mineral spirits can be used to remove oil, grease, tars, wax, and similar substances. Use a cloth dampened with mineral spirits and apply only to areas that are contaminated. Follow up the use of this mild solvent with detergent cleaning and rinsing.

SECURITY SEAL INSTALLATION

If your metrology laws require the use of physical sealing, a lead and wire security seal can be installed on the MV1 to prevent the end cap from being removed from it to gain access to the calibration switch, thereby preventing unauthorized access to the calibration adjustments.

NOTE: To install the lead and wire security seal, the two screws securing the left end cap (as viewed from the MV1 front) **MUST** be replaced with two drilled screws. They are available from the Cardinal/Detecto Parts Department. The part number is MVSK (MEDVUE SEALING KIT).

To install a lead and wire security seal, refer to Figure No. 12 and follow the steps provided below:

1. Remove the two screws securing the left end cap (as viewed from the MV1 front).
2. Install the two drilled screws (and lock washers) in the end cap making certain they are securely tightened before proceeding.
3. Thread the sealing wire through the hole in the drilled screws.
4. Pull the wire tight and install the lead seal.
5. The screws cannot be removed without damaging the seal.

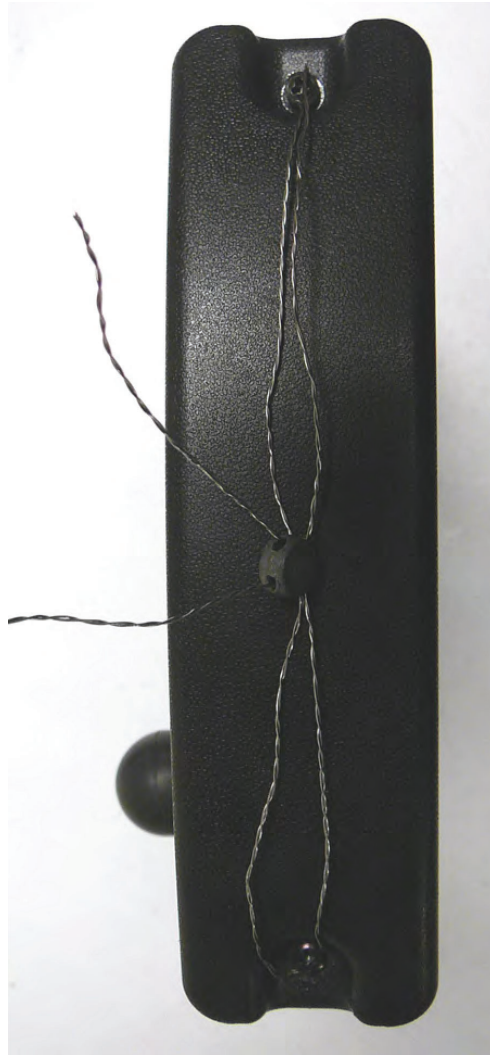
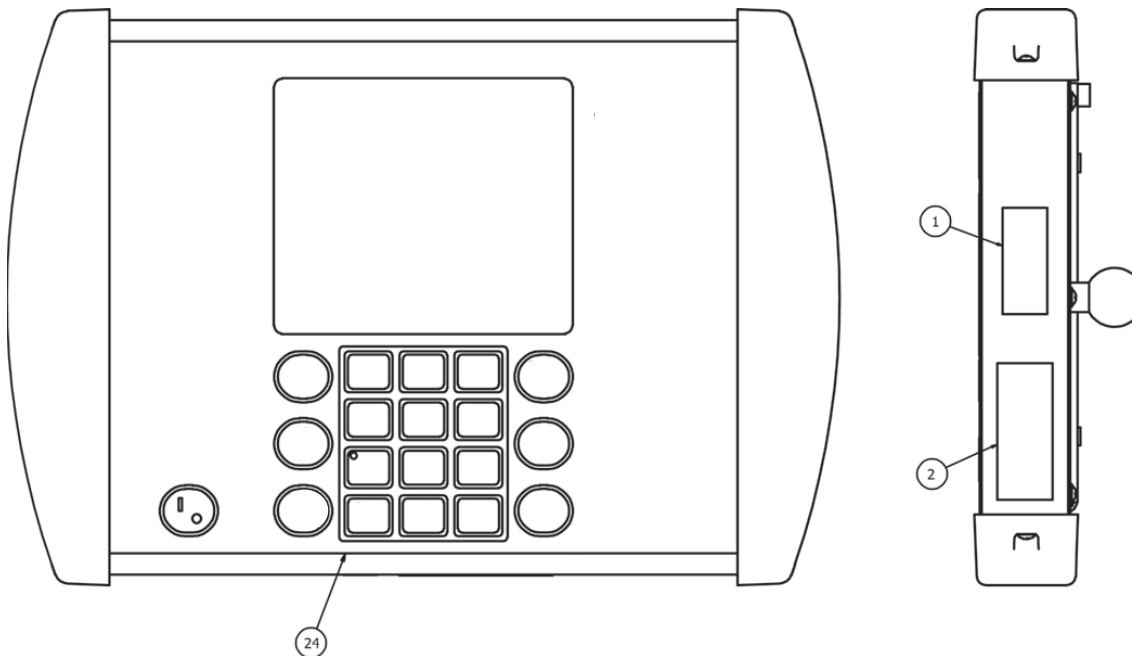

Figure No. 12

PARTS IDENTIFICATION

Item	Qty	Part Number	Description
1	1	5930-B126-08	LABEL: ETL
2	1	593GR986	SERIAL TAG ASSY
4	1	6021-1065	SCW THUMB, MACHINE-SCW 06-32X.375
5	7	6021-2069	SCW TRUSS HEAD SHEET METAL #6 X .50
6	4	6021-6008	SCW TRUSS HEAD SHEET-METAL #6 X.375
7	2	6024-0126	WASHER FLAT FOR 5/32" POP RIVET
8	1	6560-1125	ADHESIVE LOCTITE 290 THREAD LOCKER, WICKING
10	4	6610-2000	JACK SOCKET, 1 EA (NO WASHERS OR NUTS)
11	1	6610-5119	BATTERY HOLDER 6-C CELLS
12	7	6680-0004	WASHER LOCK INT TOOTH, #6 TYPE A Z-PL
13	4	6680-0052	WASHER LOCK HELICAL, #4 REG Z-PL
14	2	6680-0214	RIVET POP, BH AL 5/32 DIA x .126-.187 GR
15	1	8555-0526-0A	BACK PANEL WELDMENT
16	1	8555-0528-08	FRONT PANEL
17	1	8555-0529-08	BATTERY COVER
18	1	8555-B461-0A	CABLE: BATTERY
20	1	8555-B510-08	RUBBER BALL
21	2	8555-C213-08	END CAP
23	1	8555-0563-0A	PCB ASSEMBLY MV1 CONTROLLER
		8555-0563-2A	PCB ASSEMBLY MV1C CONTROLLER
24	1	8555-0549-08	KEYPAD, MEDVUE
*	1	MV1PWR	OPTIONAL AC ADAPTER 110-240VAC/12VDC @ 1 AMP

* NOT SHOWN



PARTS IDENTIFICATION, CONT.

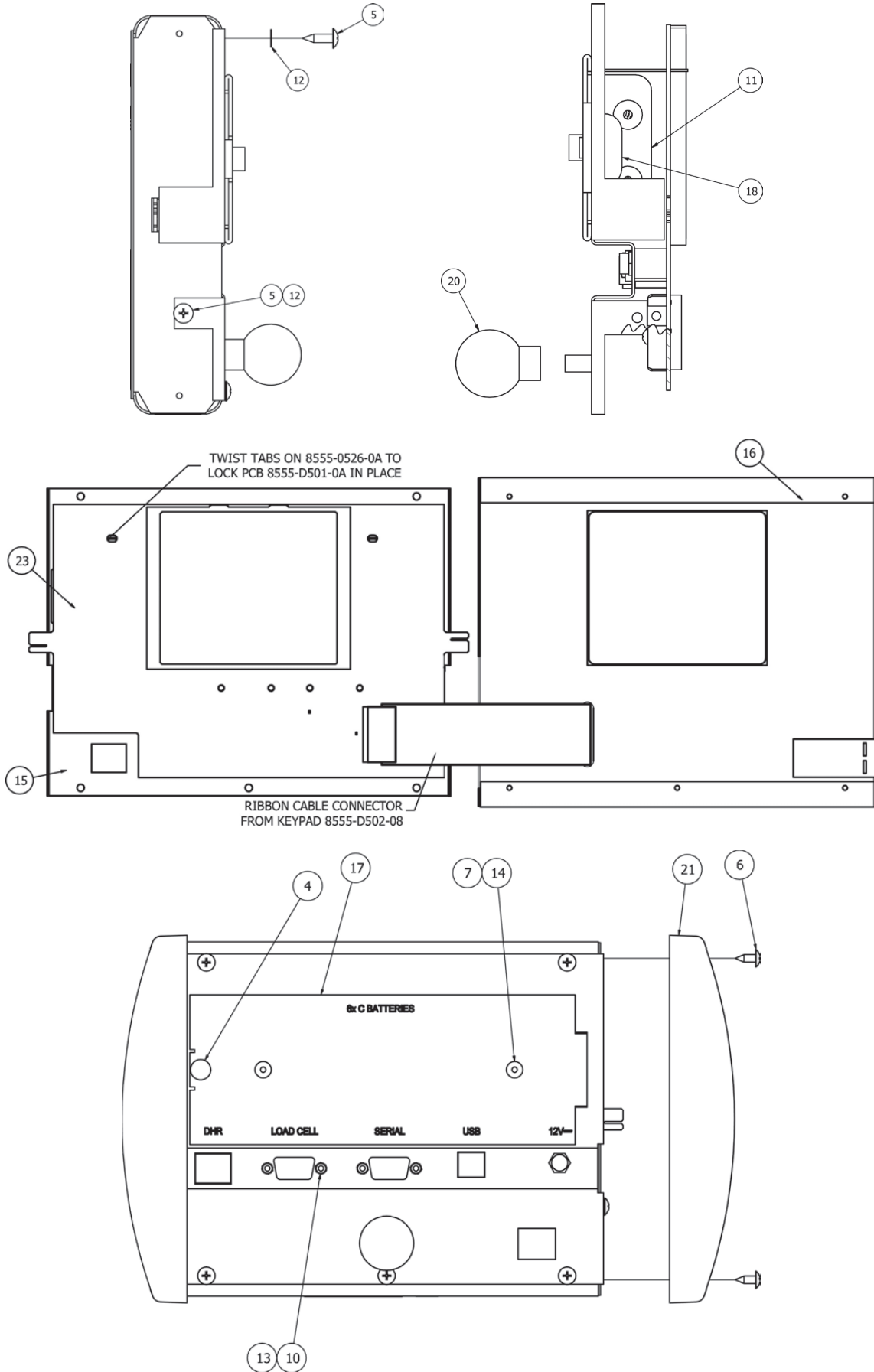

APPENDIX A (Top Plate Mounting Configurations)

**“Type One”
(0033-B104-0A)
Uses Center Mounting Hole**

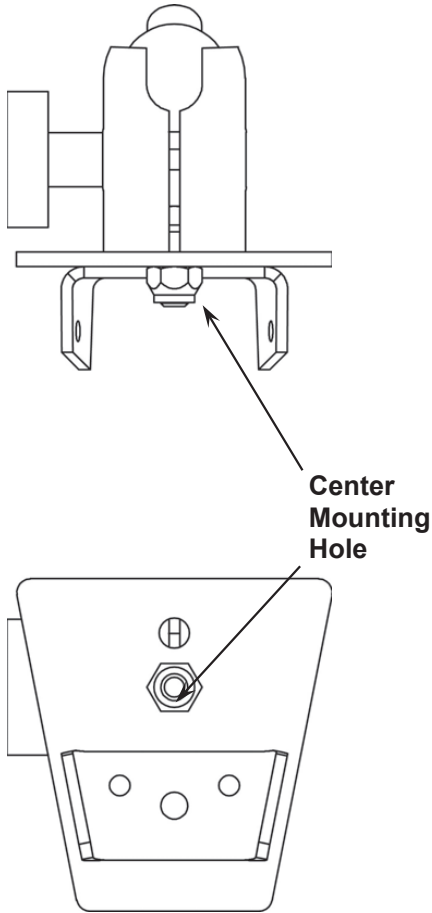

**“Type Three”
(0033-B104-0A)
Uses Front Mounting Hole**

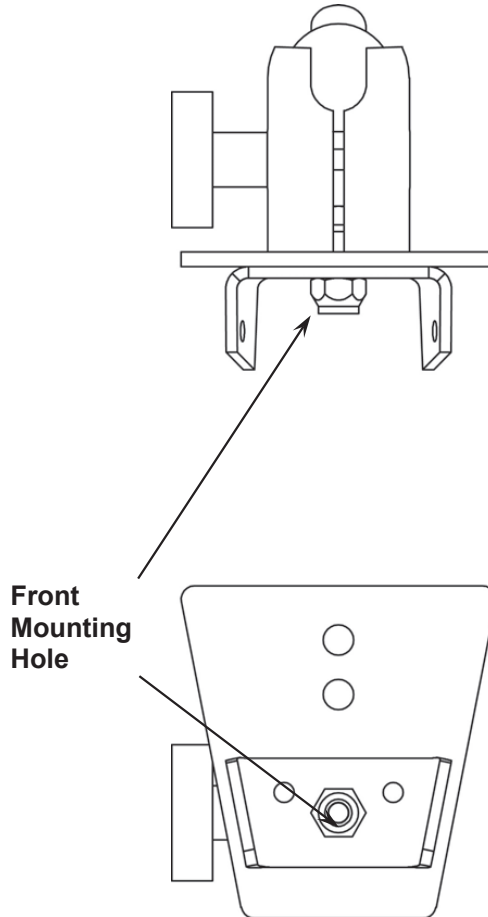

Models using “Type One”

6495
6437
6437DHR
6437KGDHR
6438
6439
6439KG
6439M
6447
6449
6449M

Models using “Type Three”

8430
8430M
8431
8431M
8437

APPENDIX A, CONT.

**“Type Four”
(8555-B517-08)
TRANSITION PLATE**

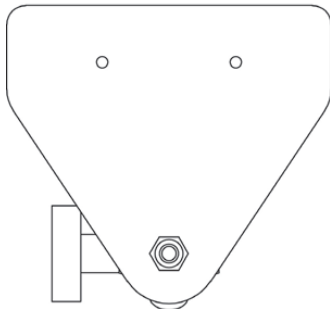
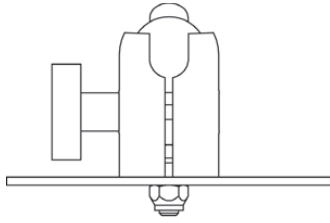

**Models using “Type Four”
6550**

**“Type Five”
(1930-C199-08)
MOUNTING BASE**

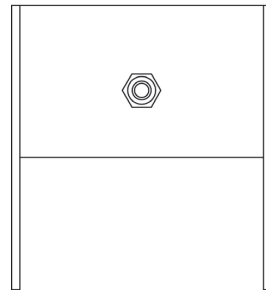
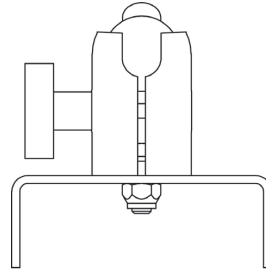

**Models using “Type Five”
6854DHR
6857DHR
6857KGDHR**

**“Type Desk/Wall Mount”
(8555-B516-08)
DESKTOP PLATE**

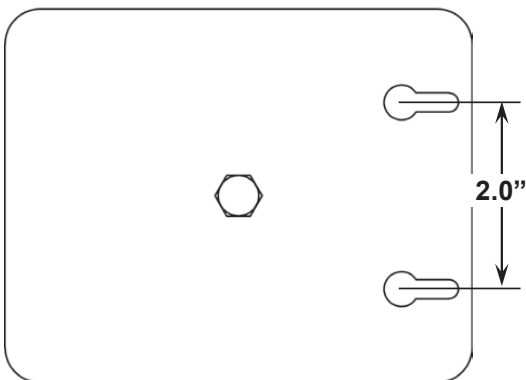
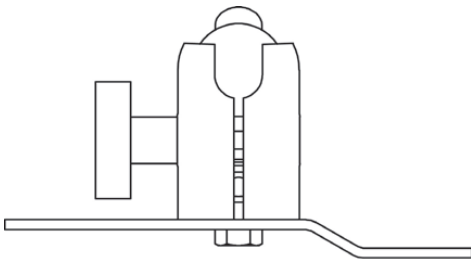

Models using “Desk/Wall Mount”

- 6500
- BRW1000
- CD-1000D
- CR-500D
- FHD-133-II
- FHD-143-II
- FHD-144-II
- FHD-164-II
- GP-400-MV1
- GP-600-MV1
- GP-600-RP

WALL MOUNTING

Mount using two (2) #10 screws placed 2.00 inches (51 mm) apart in the wall.

APPENDIX B

(Connecting to a Welch Allyn CVSM Device)

This section describes the required settings of the MedVue Model MV1 Medical Weight Analyzer to connect to a Welch Allyn CVSM device.

To enter Setup on the MedVue Model MV1 Medical Weight Analyzer, remove the two (2) Philips head screws from the right end cap (as viewed from the back of the MV1) and remove the end cap. Look for a small hole under the endcap with a red switch button behind it. It can be found near the bottom edge of the Model MV1 Medical Weight Analyzer. Refer to the CALIBRATION SETUP (Protected Setup Parameters) section for more information.

1. Press the switch with a paper clip or similar tool and you should see **SEtUP** on the top of the display and **SCALE** at the bottom.
2. If it is desired for the MedVue to automatically send the weight, height, and BMI when the weight is locked, the first setting that must be changed is the automatic lock feature of the MedVue. While in setup, press the **ID/HEIGHT** key until the display shows **LOCK** at the bottom.
3. Press the **ENTER** key and you should see **HOLD MODE** at the bottom of the MedVue display. To enable the auto locking feature, change this setting to "2" and then press the **ENTER** key.
4. The next setting that appears is the **HOLD BAND**. Enter "10" for this setting and then press the **ENTER** key. Press the **PRINT** key to return to the setup menu.
5. The next setting that must be correct for communication to work is the **USB MODE**. While in the setup menu, press the **ID/HEIGHT** key until **USB PORT** is displayed at the bottom of the MedVue display, and then press the **ENTER** key.
6. Change the **USB MODE** to "4" and then press the **ENTER** key.

NOTE: You should now have all the correct settings to communicate with the Welch Allyn device.

Auto-Lock Operation

If you have the MedVue set to auto-lock, simply apply weight to the scale. When the scale settles and the weight locks, the weight, height, and BMI information will be transmitted.

The height and BMI do not lock with the weight. If the height was not entered before applying weight on the scale, only the weight will be transmitted to the Welch Allyn device.

If the operator enters the height, either by using the digital height rod or entering the height using the keypad, the height, and calculated BMI information will be transmitted at that time.

Manual Operation

If you do not have the auto-lock enabled, pressing the **PRINT** key on the MedVue keypad will transmit the weight, height, and BMI information.

Pressing the **PRINT** key will clear the current height and BMI. If it becomes necessary to retransmit the information, it will be necessary to enter the height again.

STATEMENT OF LIMITED WARRANTY

Detecto Scale warrants its equipment to be free from defects in material and workmanship as follows: Detecto warrants to the original purchaser only that it will repair or replace any part of equipment which is defective in material or workmanship for a period of two **(2) years from date of shipment**. Detecto shall be the sole judge of what constitutes a defect.

During the **first ninety (90) days** Detecto may choose to replace the product at no charge to the buyer upon inspection of the returned item.

After the first ninety (90) days, upon inspection of the returned item, Detecto will repair or replace it with a remanufactured product. The customer is responsible for paying for the freight both ways.

This warranty does not apply to peripheral equipment not manufactured by Detecto; this equipment will be covered by certain manufacturer's warranty only.

This warranty does not include replacement of expendable or consumable parts. This does not apply to any item which has deteriorated or damaged due to wear, accident, misuse, abuse, improper line voltage, overloading, theft, lightning, fire, water or acts of God, or due to extended storage or exposure while in purchaser's possession. This warranty does not apply to maintenance service. Purchased parts will have a ninety (90) day repair or replacement warranty only.

Detecto may require the suspect product to be returned to the factory; item(s) must be properly packed and shipping charges prepaid. A return authorization number must be obtained for all returns and marked on the outside of all returned packages. Detecto accepts no responsibility for loss or damage in transit.

STATEMENT OF LIMITED WARRANTY

Conditions Which Void Limited Warranty

This warranty shall not apply to equipment which:

- A.) Has been tampered with, defaced, mishandled, or has had repairs and modifications not authorized by Detecto.
- B.) Has had serial number altered, defaced, or removed.
- C.) Has not been grounded according to Detecto's recommended procedure.

Freight Carrier Damage

Claims for equipment damaged in transit must be referred to the freight carrier in accordance with freight carrier regulations.

This warranty sets forth the extent of our liability for breach of any warranty or deficiency in connection with the sale or use of the product. Detecto will not be liable for consequential damages of any nature, including but not limited to, loss of profit, delays, or expenses, whether based on tort or contract. Detecto reserves the right to incorporate improvements in material and design without notice and is not obligated to incorporate improvements in equipment previously manufactured.

The foregoing is in lieu of all other warranties, express or implied including any warranty that extends beyond the description of the product including any warranty of merchantability or fitness for a particular purpose. This warranty covers only those Detecto products installed in the forty-eight (48) contiguous continental United States.



Ph. (800) 641-2008
E-mail: detecto@cardet.com
203 E. Daugherty
Webb City, MO 64870

08/27/2014
Printed in USA
D268-WARRANTY-DET-A



Cardinal Scale Manufacturing Co.
102 E. Daugherty, Webb City, MO 64870 USA
Ph: 417-673-4631 or 1-800-641-2008
Fax: 417-673-2153

Technical Support: 1-866-254-8261
E-mail: tech@cardet.com