

Echelon EH Series Floor Scale Setup



- 1 Locate box of feet in carton on underside of scale.



- 2 Screw foot into load cell at each corner.

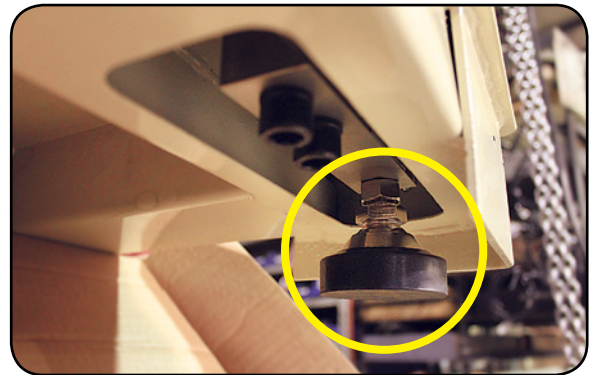

- 3 Remove the two screws and scale side cover from scale.

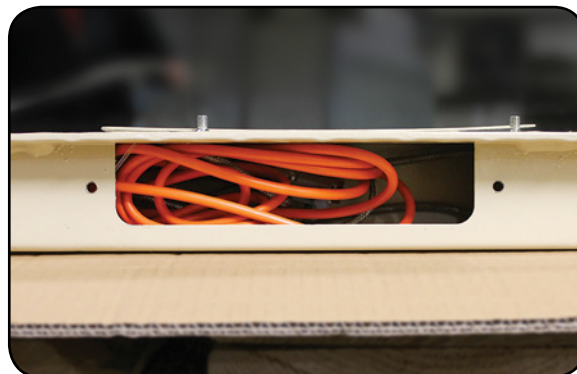
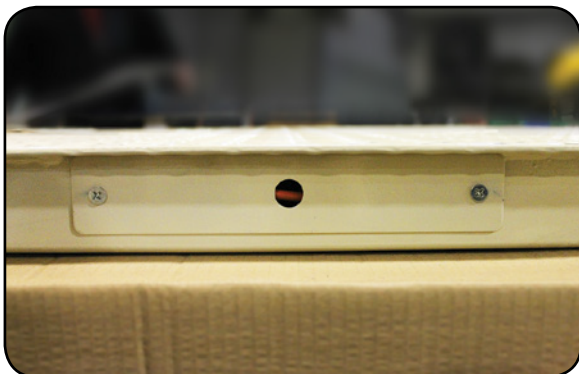

- 4 Remove junction box from scale.

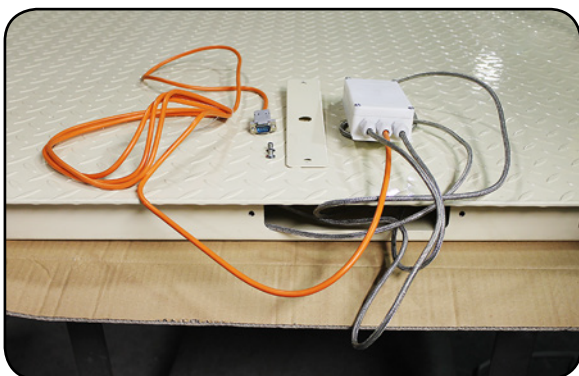

- 5 Remove the four screws and cover of the junction box.

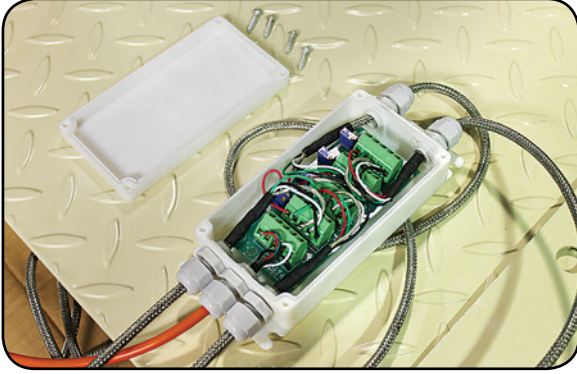

- 6 Remove indicator cable wires from terminal block.

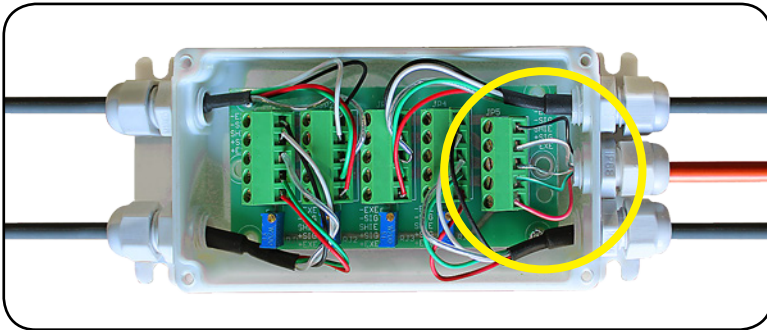

Note location of wires:

- EXE Black
- SIG White
- SHIELD May be any color
- + SIG Green
- + EXE Red

- 7 Route indicator cable through the scale side cover.

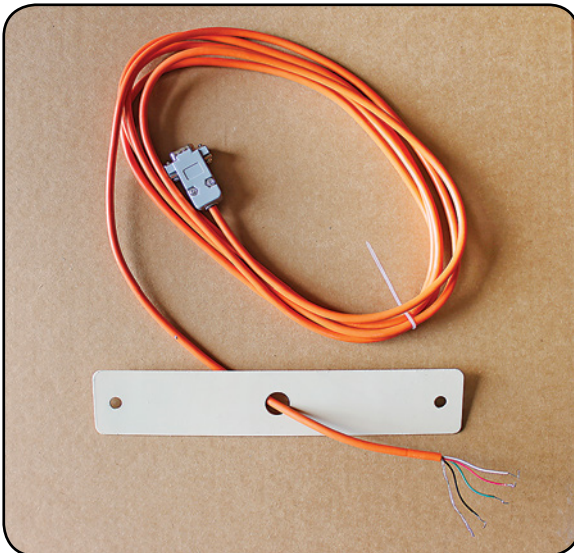

- 8** Re-connect indicator cable wires to terminal block in junction box. Ensure wires are reconnected to the proper terminals.

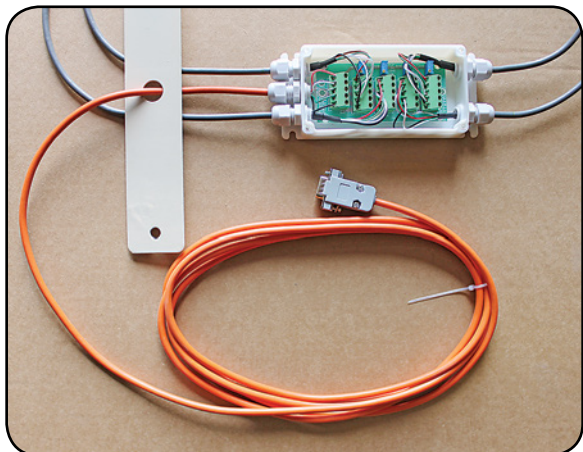

Note location of wires:

- EXE Black
- SIG White
- SHIELD May be any color
- + SIG Green
- + EXE Red

- 9** Replace cover on junction box and secure with four screws.



- 10** Place junction box in scale and re-install side cover.



Scale is now ready to connect to digital weight indicator and calibrate.