



## **PEDIATRIC SCALE**

**Models 459-CH, 8432-CH  
and 8432-CHKGEU  
Owner's Manual**



8525-M178-O1 Rev F  
11/07

CARDINAL SCALE MFG. CO.  
203 E. Daugherty, Webb City, MO 64870 USA  
PH (417) 673-4631 • FAX (417) 673-5001  
[www.detecto.com](http://www.detecto.com)

Printed in USA

Technical Support: Ph: 866-254-8261 • [tech@cardet.com](mailto:tech@cardet.com)



# INTRODUCTION

Thank you for purchasing our Detecto Pediatric Scale, Model 459-CH, 8432-CH or 8432-CHKGEU. Your scale was built with Detecto quality and reliability. This manual will guide you through setup and operation of your scale. Please read it thoroughly before attempting to operate your scale and keep it handy for future reference.

## SPECIFICATIONS

### 459-CH

Capacity: ..... 40 lb x 1/2 oz (17 1/2 kg x 10 g)

### 8432-CH\*

Capacity: ..... 44 lb x .05 oz (20 kg x .02kg)

Power Requirements: ..... 6 "AA" size Alkaline, Ni-Cad or NiMH batteries (*not included*) OR an optional 100 to 240 VAC 50/60Hz 12 VDC 1A wall plug-in UL/CSA listed AC power supply.

Operating Temperature: ..... 14 to 104 °F (-10 to +40 °C)

### 8432-CHKGEU\*\*

Capacity: ..... 44 lb x .05 oz (20 kg x .02kg)

Power Requirements: ..... 6 "C" size Ni-Cad or NiMH batteries (*not included*) OR an optional 115 VAC 50/60Hz 12 VDC 300 mA wall plug-in UL/CSA listed power supply. (Also available for 230 VAC 50/60 Hz).

Operating Temperature: ..... 14 to 104 °F (-10 to +40 °C)

\* For more information on the indicator used on the 8432-CH, refer to the 750 Weight Indicating Instrument Owner's Manual, 8555-M260-O1.

\*\* For more information on the indicator used on the 8432-CHKGEU, refer to the 758CSV Weight Indicating Instrument Owner's Manual, 8555-M433-O1.

## FCC COMPLIANCE STATEMENT

The Model 8432-CH generates uses and can radiate radio frequency energy and if not installed and used in accordance with the instructions manual, may cause interference to radio communications. It has been tested and found to comply with the limits for a Class A computing device pursuant to Subpart J of Part 15 of FCC rules, which are designed to provide reasonable protection against such interference when operated in a commercial environment. Operation of this equipment in a residential area is likely to cause interference in which case the user, at his own expense, will be required to take whatever measures may be required to correct the interference.



You may find the booklet "How to Identify and Resolve Radio TV Interference Problems" prepared by the Federal Communications Commission helpful. It is available from the U.S. Government Printing Office, Washington, D.C. 20402, Stock No. 001-000-00315-4.

All rights reserved. Reproduction or use, without express permission, of editorial or pictorial content, in any manner, is prohibited. No patent liability is assumed with respect to the use of the information contained herein. While every precaution has been taken in the preparation of this book, we assume no responsibility for errors or omissions. Neither is any liability assumed for damages resulting from the use of the information contained herein. All instructions and diagrams have been checked for accuracy and ease of application; however, success and safety in working with tools depend, to a great extent, upon the individual accuracy, skill and caution. For this reason, we are not able to guarantee the result of any procedure contained herein. Nor can we assume responsibility for damage to property or injury to persons engaging the procedures do so entirely at their own risk.

## CARE and CLEANING of SCALE

- **DO NOT** subject the platform (child seat) to sudden shocks.
  - **DO NOT** expose scale to temperature extremes.
  - **DO NOT** place scale in front of heating/cooling vents.
  - **DO NOT** place scale in areas where it might be exposed to moisture.
  - **DO NOT** submerge scale in water, pour or spray water directly on head assembly or indicator.
  - **DO NOT** use an abrasive cleaner, acetone or other volatile solvents for cleaning head assembly, indicator, platform base or child seat.
- 
- **DO** clean the head assembly, indicator or platform base with a damp soft cloth and mild non-abrasive detergent.
  - **DO** clean the child seat with a soft cloth dampened with a mild detergent. The child seat may be removed and washed with a mild detergent.
  - **DO** remove power on 8432-CH or 8432-CHKGEU before cleaning with a damp cloth.
  - **DO** provide clean AC power and adequate protection against lightning damage for 8432-CH or 8432-CHKGEU.

**PRECAUTIONS**  
Before using this instrument, read this manual and pay special attention to all "WARNING" symbols:

 IMPORTANT  ELECTRICAL WARNING

SERIAL NUMBER \_\_\_\_\_  
DATE OF PURCHASE \_\_\_\_\_  
PURCHASED FROM \_\_\_\_\_  
\_\_\_\_\_  
\_\_\_\_\_  
RETAIN THIS INFORMATION FOR FUTURE USE

## UNPACKING INSTRUCTIONS

Carefully unpack scale components from the shipping carton. Examine the scale and baby seat for any damage that may have taken place during shipment. If you find evidence of shipping damage, the shipping company should be contacted at once. It is a good idea to keep the scale shipping carton and packing material for later use should storage or transport of the scale become necessary.

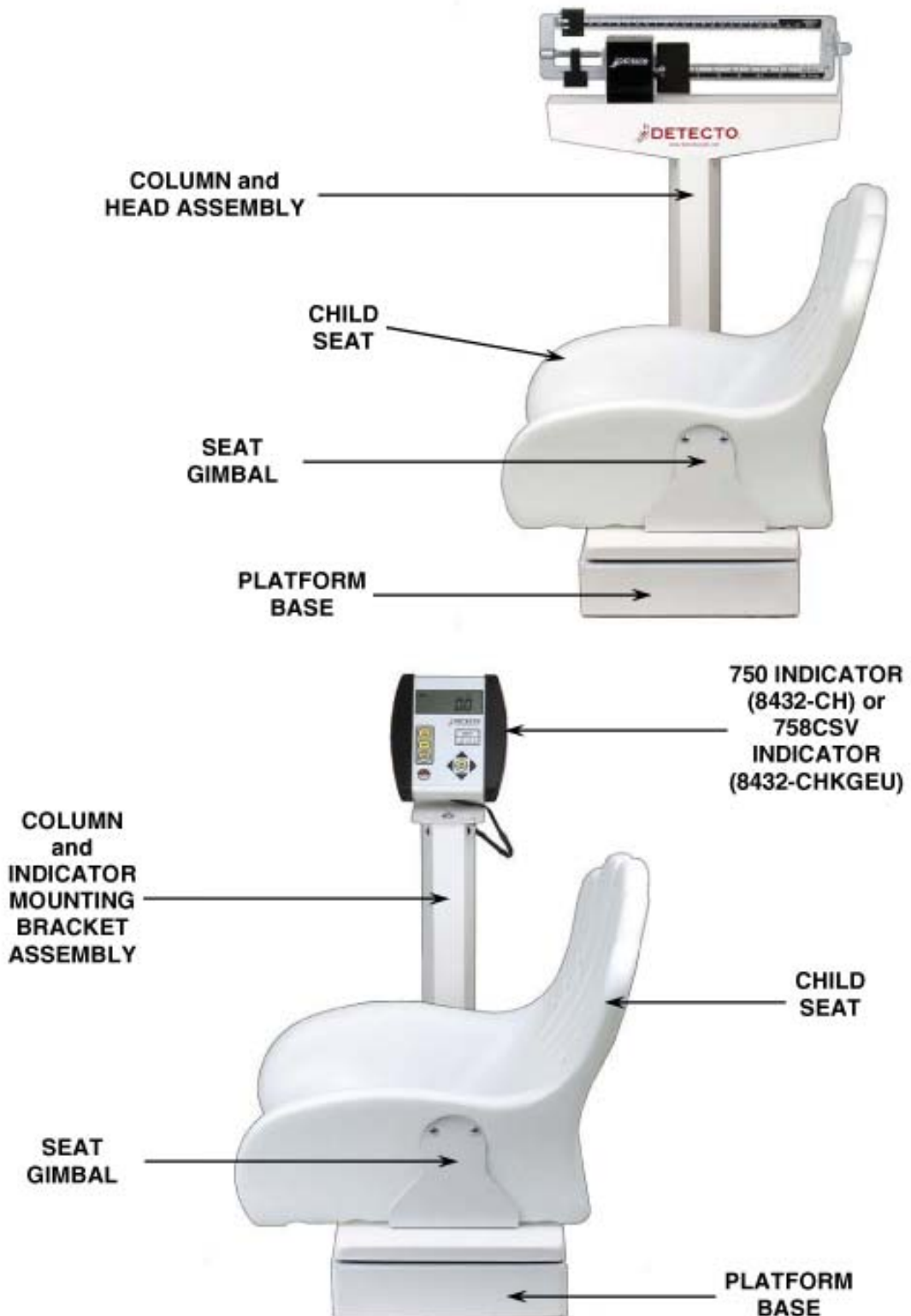

# CHILD SEAT INSTALLATION

Before using the scale, it will be necessary to install the child seat. Follow the steps listed below to install the child seat.

## PARTS LIST

- (1) Child Seat
- (1) Gimbal
- (4) 1/4-20 x 1/2" Truss head screws
- (4) #10-24 x 1/2" Truss head screws

## TOOLS REQUIRED

#1 Philips

1. Remove child seat and hardware kit (plastic bag with screws) from box.
2. Remove child seat gimbal from packing.



3. Remove mounting screws from plastic bag.

1/4-20 x 1/2" screws  
(gimbal to platform)



#10-24 x 1/2" screws  
(seat to gimbal)

4. Determine which direction child seat is to face, left or right side of scale or forward (away from beam or indicator) and place gimbal on scale.



## CHILD SEAT INSTALLATION, Cont.

5. Align holes in gimbal with holes in scale platform and attach to scale platform with four 1/4-20 x 1/2" screws.
6. Tighten screws with Philips screw driver.
7. After gimbal is installed, position child seat in gimbal and attach with #10-24 x 1/2" screws (two screws on each side).

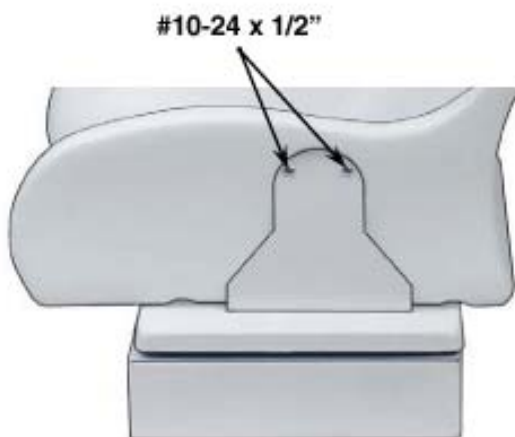
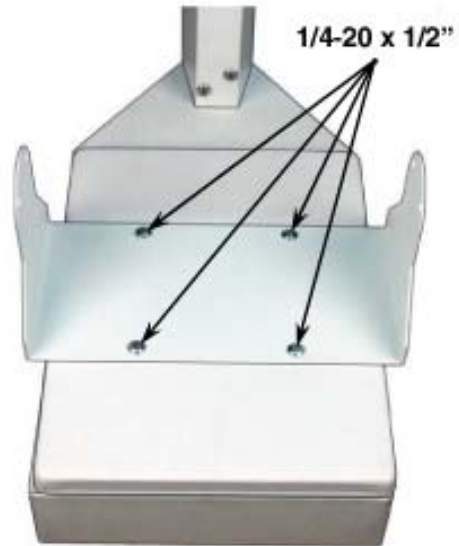

8. Periodically re-check screws for tightness.
9. Proceed to SETUP INSTRUCTIONS for your particular scale model





## 459-CH SETUP INSTRUCTIONS

Before using the scale, it must be balanced (zeroed). To zero the scale, perform the following:

1. Place the scale on a level, stable surface.
2. Referring to the illustration, move both poises to zero.
3. Locate the BALANCE SCREW on the left end of the beam and turn it in or out as required, until the BEAM POINTER is in the center of the opening in the TRIG LOOP.
4. The scale is now ready for operation.

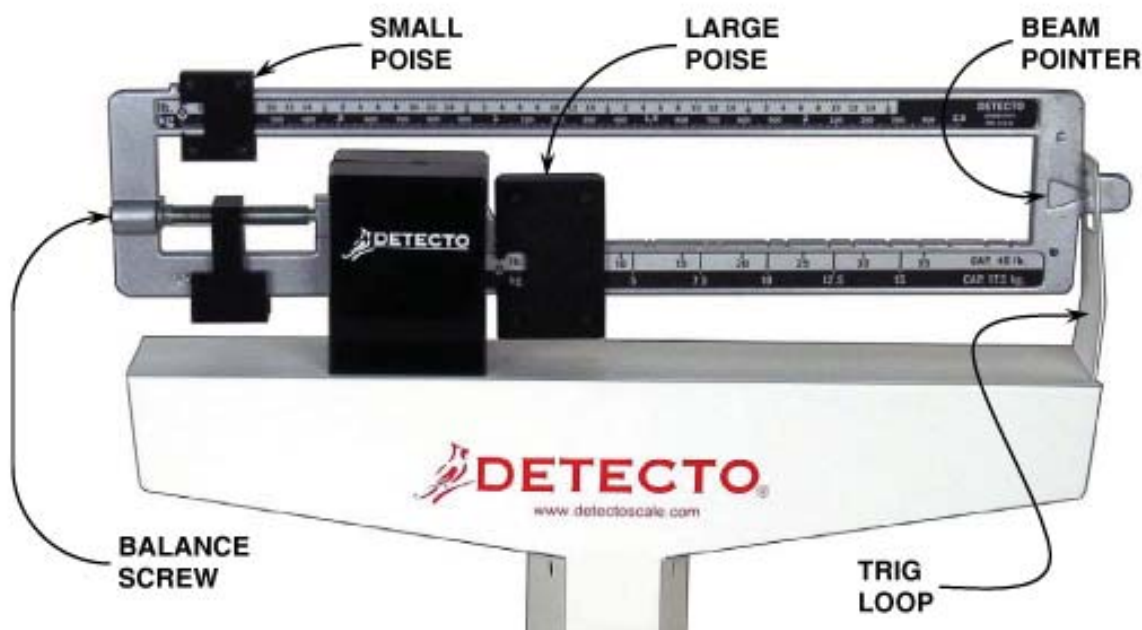

## 459-CH OPERATING INSTRUCTIONS

1. Place the scale on a level, stable surface.
2. With the child seat empty, move both poises to the Zero position. Be sure the BEAM POINTER is in the center of the opening in the TRIG LOOP.
3. Slide the LARGE POISE to the approximate weight of the child. I.E. If the child weighs approximately 25 pounds, slide the LARGE POISE to 25 pounds.
4. Lay the child being weighed in the center of the seat. This will distribute the weight evenly across the scale.
5. Slide the SMALL POISE to the middle of the beam (between 2 and 3 pounds).
6. Continue sliding the SMALL POISE until the BEAM POINTER is centered in the TRIG LOOP opening.
7. Read the SMALL POISE at the pointer and add to the weight from the LARGE POISE. I.E. If the LARGE POISE is at 25 pounds and the SMALL POISE is at 4 pounds, 6 ounces, the child weighs 29 pounds, 6 ounces.

### CAUTION!



**Do not leave the child unattended in the child seat. Failure to maintain continual control of the child can result in serious injuries should the child fall from the child seat.**

**NOTE! The seat straps have been intentionally omitted!**



# 8432-CH SETUP INSTRUCTIONS

## AC Power Supply

To operate the 8432-CH scale without batteries, connect the 12 VDC power supply's connector into the power jack on the lower back of the indicator and then plug the power supply into the proper electrical outlet. On models requiring 220 VAC, it is the customer's responsibility to obtain the correct power adapter plug. The scale is now ready for operation.

**NOTE!** The AC power supply is also used to recharge the batteries in the indicator, when the scale is operated from Ni-Cad or NiMH batteries.

## Batteries

Battery operation is a standard feature of the Detecto 750 indicator used on the scale, although the batteries are optional (not included). The indicator can be operated from 6 "AA" size Alkaline, Ni-Cad or NiMH batteries. The batteries are contained in a battery holder inside the indicator which is accessible by removing a panel on the back of the indicator.

*When using batteries, all 6 batteries must be of the same type. They must be all Alkaline, all Ni-Cad or all NiMH. In addition, **DO NOT** mix Ni-Cad or NiMH batteries.*



**CAUTION!** The indicator has circuitry that when used with the external power supply, recharges the Ni-Cad or NiMH batteries. Therefore, **DO NOT** connect a power supply to the indicator if using alkaline batteries.

## Battery Operation

The scale will operate for up to 250 hours on new alkaline batteries or for up to 100 hours on fully charged Ni-Cad or NiMH batteries, depending on the condition of the batteries (from new to about 500 recharges). A bar graph on the display shows the battery capacity in 4 steps:

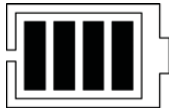

- 4 segments - the full battery capacity is available,
- 3 segments - the battery is at 75% of capacity,
- 2 segments - the battery is at 50% of capacity,
- 1 segment: - the battery is at 25% capacity.

When the battery voltage drops too low for accurate weighing, the indicator will show *L o b A t* and then shut off. You will be unable to turn the indicator back on until the alkaline batteries have been replaced. If using Ni-Cad or NiMH batteries connect the AC power supply to the indicator and then plug it into the proper electrical outlet to begin charging the batteries.

## Battery Charging

The AC power supply must be plugged into a proper electrical outlet and connected to the indicator for approximately 8 to 10 hours to fully recharge the batteries. Note that while the batteries are charging the indicator can still be operated and that charging the batteries for more than 10 hours *will not* damage them.

## 8432-CH SETUP INSTRUCTIONS, Cont.

### Battery Installation/Replacement

To install or remove batteries, perform the following steps:

1. Pull Spring Plunger Release and hold while removing indicator from bracket on scale.
2. Turn indicator so display is facing away from you (resting on keypad).
3. Locate the rectangular panel on back of indicator.
4. To install or replace batteries, first remove battery holder cover by pushing in on the tab and lifting it up.
5. If installing new batteries, proceed to step 6. If replacing the batteries, remove all 6 batteries from the battery holder and then proceed to step 6.
6. Install 6 new “AA” size batteries in the battery holder, noting polarity markings located in battery holder.
7. After placing all 6 batteries in battery holder, replace battery cover.
8. Make sure power supply is unplugged, and then turn indicator over (display facing up) and press **ON/OFF** key.
9. If display turns on, batteries have been installed correctly. If not, remove panel and check for one or more improperly positioned batteries.
10. Return indicator to scale bracket by placing screw heads on back of indicator into large end of slotted holes in bracket. Pull down to secure the indicator. Spring plunger will lock indicator to bracket.
11. Scale is now ready for operation.

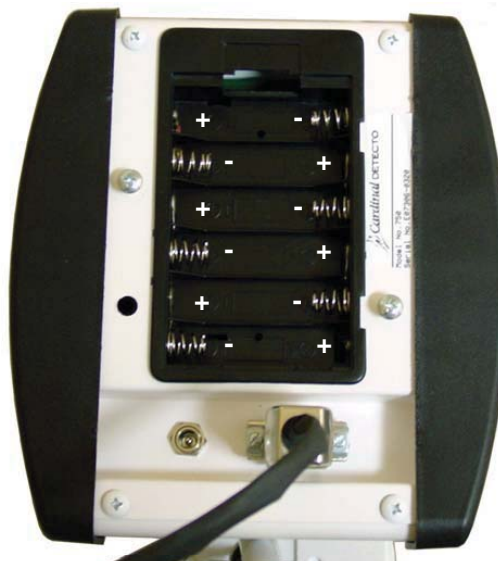
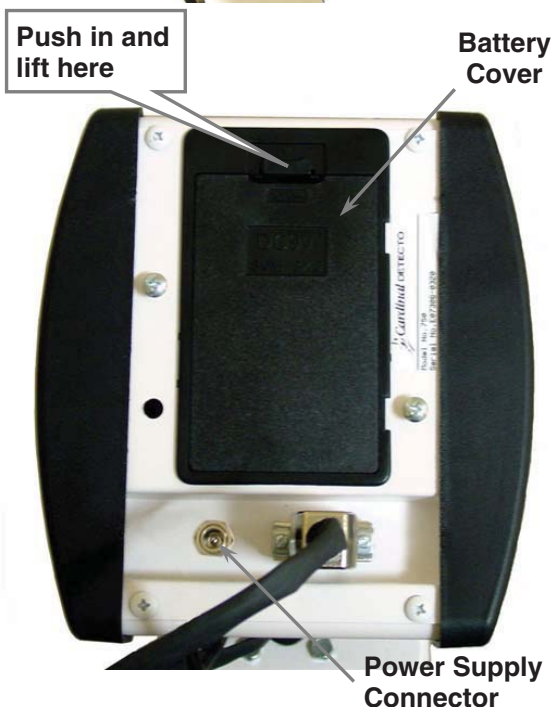
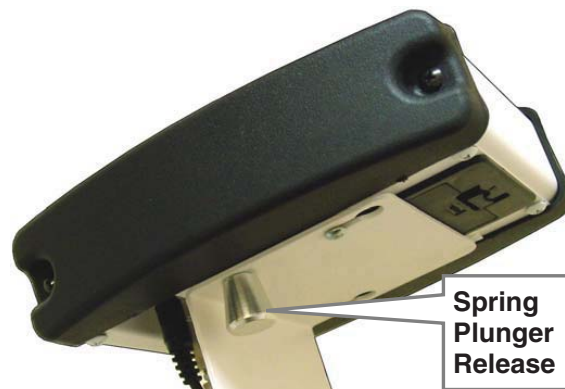

# 8432-CH OPERATING INSTRUCTIONS

## Basic Weighing

1. Place scale on a level, stable surface.
2. With the child seat empty, press **ON/OFF** key.
3. Press **ZERO** key to zero weight display. ZERO, ▲▲ (STABLE) and lb or kg annunciators will turn on to show that scale is ready for use.
4. Lay child being weighed in center of seat. This will distribute the weight evenly across scale platform.
5. Read weight display.
6. Remove child from seat.



## Zero Weight Display

1. If weight display is not showing zero weight, press **ZERO** key.
2. Weight display will return to zero. ZERO, ▲▲ (STABLE) and lb or kg annunciators will turn on to show a stable, center-of-zero weight condition.

## Zero Weight Display with Item on Scale

1. Place item (blanket or similar covering) on scale.
2. Weight display will show weight of item on scale.
3. Press **ZERO** key.
4. Weight display will return to zero. ZERO, ▲▲ (STABLE) and lb or kg annunciators will turn on. The item's weight has been "zeroed off".
5. Proceed with weighing operation.

## Metric Conversion

Press **UNITS** key to toggle between pounds and kilograms. The lb or kg annunciator will turn on to show which weighing unit is active.

**DO NOT** press the keys on the keypad with pointed objects (pencils, pens, etc).  
Damage to the keypad resulting from this practice is **NOT** covered under warranty.



## CAUTION!

**Do not leave the child unattended in the child seat. Failure to maintain continual control of the child can result in serious injuries should the child fall from the child seat.**  
**NOTE! The seat straps have been intentionally omitted!**

# 8432-CHKGEU SETUP INSTRUCTIONS

## AC Power Supply

To operate the 8432-CHKGEU scale without batteries, connect the 12 VDC power supply's connector into the power jack on the back of the indicator and then plug the power supply into the proper electrical outlet. On models requiring 220 VAC, it is the customer's responsibility to obtain the correct power adapter plug. The scale is now ready for operation.

**NOTE!** The AC power supply is also used to recharge the batteries in the indicator, when the scale is operated from Ni-Cad or NiMH batteries.

## Batteries

Battery operation is a standard feature of the Detecto 758CSV indicator used on the scale, although the batteries are optional (not included). The indicator can be operated from 6 "C" size Ni-Cad or NiMH batteries. The batteries are contained in a battery holder inside the indicator which is accessible by removing a panel on the back of the indicator.

**IMPORTANT!** When using batteries, all 6 batteries must be the same type. They must be all Ni-Cad or all NiMH. **DO NOT** mix Ni-Cad or NiMH batteries.



**CAUTION!** The indicator has circuitry that when used with the external power supply, recharges the Ni-Cad or NiMH batteries. Therefore, you **CAN NOT** use alkaline batteries in it.

## Battery Status

When batteries are used, the indicator will show the battery status on power up. The display will show  $b\bar{r}\bar{t}\bar{t}\bar{r}\bar{y}$  and then change to  $\equiv \bar{y}\bar{y} \equiv$ , where YY indicates the remaining battery voltage expressed as a percentage (%) of the total battery voltage

## Low Battery Indicator

The  $L\bar{D}\ b\bar{r}\bar{t}$  (low battery) annunciator turns ON to indicate the batteries will soon need to be recharged. Normal operation will continue until the battery voltage drops to too low for accurate weighing. When this occurs, the indicator will automatically turn itself off and you will be unable to turn it back on. Connect the AC power supply to the indicator and then plug it into the proper electrical outlet to begin charging the batteries.

## Battery Charging

The AC power supply must be plugged into a proper electrical outlet and connected to the indicator for approximately 6 hours to fully recharge the batteries. Note that while the batteries are charging the indicator can still be operated and that charging the batteries for more than 6 hours *will not* damage them.



## 8432-CHKGEU SETUP INSTRUCTIONS, Cont.

### Battery Installation/Replacement

To install or remove batteries, perform the following steps:

1. Push latch release down flush with back of indicator and hold while removing indicator from bracket on scale.
2. Turn indicator so display is facing away from you (resting on keypad).
3. Locate rectangular panel on back of indicator and remove thumb screw.
4. To install or replace batteries, remove panel (lift straight up and slide out) exposing battery holder.

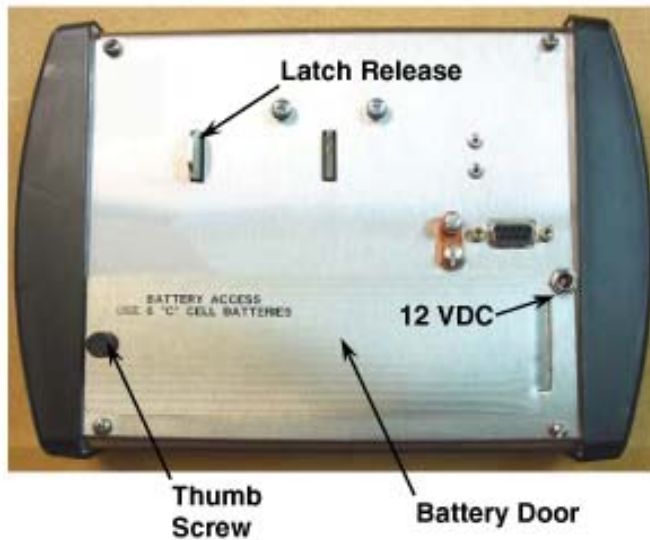

5. If installing new batteries, proceed to step 6. If replacing the batteries, remove all 6 batteries from the battery holder and then proceed to step 6.
6. Install 6 new "C" size batteries in the battery holder, noting polarity markings located in battery holder.
7. After placing all 6 batteries in battery holder, replace panel on back of indicator (slide tab into slot on rear panel) and install thumb screw.
8. Make sure power supply is unplugged, and then turn indicator over (display facing up) and press **ON/OFF** key.
9. If display turns on, the batteries have been installed correctly. If not, remove panel and check for one or more improperly positioned batteries.
10. Return indicator to scale bracket by pushing latch release down flush with back of indicator and holding. Next, place large end of slotted holes in bracket over screw heads on back of indicator. Pull down to secure indicator. Release latch release to lock indicator to bracket.
11. Scale is now ready for operation.



ON/OFF key



# 8432-CHKGEU OPERATING INSTRUCTIONS

## Basic Weighing

1. Place scale on a level, stable surface.
2. With the child seat empty, press **ON/OFF** key.
3. Press **ZERO** key to zero weight display. ZERO, ▲▲ (STABLE) and kg annunciators will turn on to show that scale is ready for use.
4. Lay child being weighed in center of seat. This will distribute the weight evenly across scale platform.
5. Read weight display.
6. Remove child from seat.

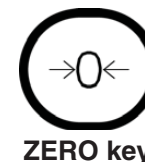

## Zero Weight Display

1. If weight display is not showing zero weight, press **ZERO** key.
2. Weight display will return to zero. ZERO, ▲▲ (STABLE) and kg annunciators will turn on to show a stable, center-of-zero weight condition.

## Zero Weight Display with Item on Scale

1. Place item (blanket or similar covering) on scale.
2. Weight display will show weight of item on scale.
3. Press **ZERO** key.
4. Weight display will return to zero. ZERO, ▲▲ (STABLE) and kg annunciators will turn on. The item's weight has been "zeroed off".
5. Proceed with weighing operation.

**DO NOT** press the keys on the keypad with pointed objects (pencils, pens, etc).  
**Damage to the keypad resulting from this practice is NOT covered under warranty.**

## CAUTION!



**Do not leave the child unattended in the child seat. Failure to maintain continual control of the child can result in serious injuries should the child fall from the child seat.**  
**NOTE! The seat straps have been intentionally omitted!**



## ERROR CODES

The indicators used on the 8423-CH and 8423-CHKGEU scale are equipped with a diagnostic software program that tests various portions of the instrument's circuitry and verifies proper operation. Should a problem be detected, an error or status message will be displayed alerting the operator to the condition. The following lists these errors and status displays and their meaning.

<b>DISPLAY</b>	<b>MEANING</b>
-Err-	General error, invalid keypad entry was attempted.
-DF-	Attempting to display a negative number greater than -9,999 or a positive number greater than 99,999
-t r L-	Indicates an attempt to zero a weight outside scale zero range. (See Four Percent Zero Tracking Range Limit).
-UnS-	Motion is present when indicator is attempting to perform one of the following operations: Power Up Zero or Zero Weight Display
CRLib	Indicates calibration is necessary.
AdErr	These error messages are displayed on both the 8432-CH and the 8432-CHKGEU. Consult your scale service representative.
ErrAL	
ErrRH	
ErrR	These error messages are ONLY displayed on the 8432-CHKGEU. Consult your scale service representative.
EE Err	
OCAP	Scale weight exceeds scale capacity
OFF	Displayed to indicate indicator is turning off.

## BEFORE YOU CALL FOR SERVICE

<b>PROBLEM</b>	<b>POSSIBLE SOLUTIONS</b>
Display does not turn on	<p>AC Operation:</p> <ul style="list-style-type: none"> <li>• Is AC power supply fully inserted into wall receptacle?</li> <li>• Check wall receptacle for proper AC power. Try another electrical appliance in same receptacle, does it work?</li> <li>• Check circuit breaker.</li> <li>• Has there been power failure?</li> </ul> <p>Battery operation:</p> <ul style="list-style-type: none"> <li>• Check if batteries are installed and correctly.</li> <li>• Are batteries discharged?</li> </ul> <p>If Ni-Cad or NiMH, connect 12 VDC power supply's connector into power jack on back of indicator and then plug power supply into proper electrical outlet to operate indicator and recharge batteries.</p> <p><i>On 8432-CH only, if using Alkaline batteries, remove old batteries and replace with new ones.</i></p>
Incorrect weight displayed	<p>Insure child seat isn't touching an adjacent object.</p> <p>Have proper operating instructions been followed?</p>
Indicator will not display weight	Refer to Error and Status Displays section.

## STATEMENT OF LIMITED WARRANTY

Detecto Scale warrants its equipment to be free from defects in material and workmanship as follows: Detecto warrants to the original purchaser only that it will repair or replace any part of equipment which is defective in material or workmanship for a period of one **(1) year** from date of shipment. Detecto shall be the sole judge of what constitutes a defect.

During the **first ninety (90) days** Detecto may choose to supply all necessary replacement parts and service during normal weekday working hours at no charge to the buyer.

**After the first ninety (90) days** Detecto will supply parts and service at the job site provided the owner agrees to pay the Dealer for all travel time, including mileage and test equipment, as well as any expenses incurred over the direct labor of the technician at the job site. This limited warranty honors only labor performed by Detecto authorized dealers.

This warranty does not apply to peripheral equipment not manufactured by Detecto; this equipment will be covered by certain manufacturer's warranty only.

This warranty does not include replacement of expendable or consumable parts. This does not apply to any item which has deteriorated or damaged due to wear, accident, misuse, abuse, improper line voltage, overloading, theft, lightning, fire, water or acts of God, or due to extended storage or exposure while in purchaser's possession. This warranty does not apply to maintenance service. Purchased parts will have a ninety (90) day repair or replacement warranty only.

Detecto may require components be returned to the factory; they must be properly packed and shipping charges prepaid. A return authorization number must be obtained for all returns and marked on the outside of all returned packages. Detecto accepts no responsibility for loss or damage in transit.

# STATEMENT OF LIMITED WARRANTY

## Conditions Which Void Limited Warranty

This warranty shall not apply to equipment which:

- A.) Has been tampered with, defaced, mishandled or have had repairs and modifications not authorized by Detecto.
- B.) Has had serial number altered, defaced, or removed.
- C.) Has not been grounded according to Detecto's recommended procedure.

## Freight Carrier Damage

Claims for equipment damaged in transit must be referred to the freight carrier in accordance with freight carrier regulations.

This warranty sets forth the extent of our liability for breach of any warranty or deficiency in connection with the sale or use of the product. Detecto will not be liable for consequential damages of any nature, including but not limited to, loss of profit, delays or expenses, whether based on tort or contract. Detecto reserves the right to incorporate improvements in material and design without notice and is not obligated to incorporate improvements in equipment previously manufactured.

The foregoing is in lieu of all other warranties, express or implied including any warranty that extends beyond the description of the product including any warranty of merchantability or fitness for a particular purpose. This warranty covers only those Detecto products installed in the forty-eight (48) contiguous continental United States.



Ph. (800) 641-2008  
E-mail: [detecto@cardet.com](mailto:detecto@cardet.com)  
203 E. Daugherty  
Webb City, MO 64870

02/06  
Printed in USA  
D268-WARRANTY-DET

